

Clappa

4 mm Profiles

PROFİLSE - SİLAS ORMAN ÜRÜNLERİ

KAĞIT ÜZERİNDEN ÖLÇÜ ALMAYINIZ !!!

Don't measurate on paper.

ÜRÜN KODU : 04*16

(Product Code)

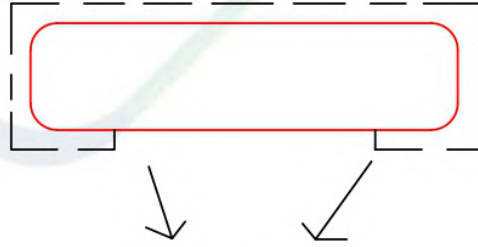
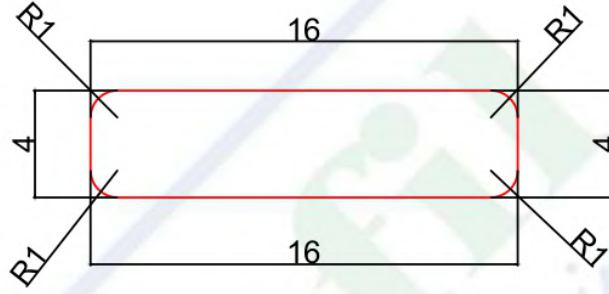

PVC BİTİŞ YERİ
(Pvc ending area)

BÖLÜM SORUMLUSU NEJDET ALTINTOPRAK	BU ÇİZİM PROFİLSE - SİLAS ORMAN ÜRÜNLERİ'NE AİTTİR. İZİNSİZ ÇOĞALTILMAMAK VE KOPYA EDİLMEMEK ŞARTI İLE İZİN VERİLMİŞTİR.	PVC ENİ : MDF MİKTARI : PLAKADAN ÇIKAN :	KSM ÖLÇÜCÜ :	KUTU İÇİ : KUTU İÇİ ADET :
ARGE SORUMLUSU DOĞUKAN DEMİR	THIS DRAWING PROFILE - SILAS FOREST PRODUCTS WHAT TO DO. UNLOCKED AND COPY NOT ALLOWED WITH THE WRITTEN.	GENEL TOLERANS : PROFİL BOY TOLERANSI :	MATERIAL MM MDF	TARİH / DATE 04.10.2018

4 mm Profiles

PROFİLSE - SİLAS ORMAN ÜRÜNLERİ

KAĞIT ÜZERİNDEN ÖLÇÜ ALMAYINIZ !!!

Don't measurate on paper.

ÜRÜN KODU : 04*30
(Product Code)

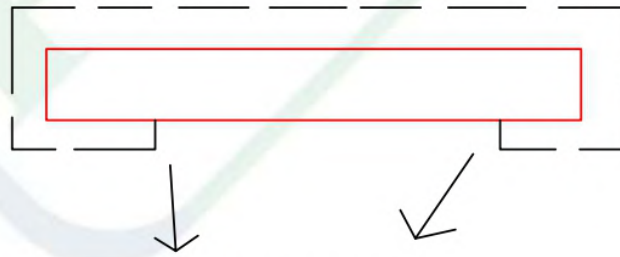

PVC BİTİŞ YERİ
(Pvc ending area)

BÖLÜM SORUMLUSU NEJDET ALTINTOPRAK	BU ÇİZİM PROFİLSE - SİLAS ORMAN ÜRÜNLERİ'NE AİTTİR. İZİNSİZ ÇOĞALTILMAMAK VE KOPYA EDİLMEMEK ŞARTI İLE İZİN VERİLMİŞTİR.	PVC ENİ : MDF MİKTARI : PLAKADAN ÇIKAN :	KSM ÖLÇÜCÜ :	KUTU İÇİ : KUTU İÇİ ADET :
ARGE SORUMLUSU DOĞUKAN DEMİR	THIS DRAWING PROFILE - SİLAS FOREST PRODUCTS WHAT TO DO. UNLOCKED AND COPY NOT ALLOWED WITH THE WRITTEN.	GENEL TOLERANS : PROFİL BOY TOLERANSI :	MATERIAL MM MDF	TARİH / DATE 10.09.2018

4 mm Profiles

PROFİLSE - SİLAS ORMAN ÜRÜNLERİ

KAĞIT ÜZERİNDEN ÖLÇÜ ALMAYINIZ !!!

Don't measurate on paper.

ÜRÜN KODU : 04*50
(Product Code)

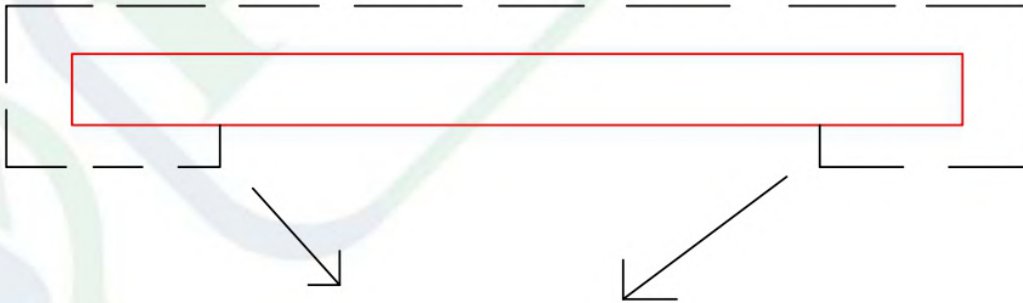
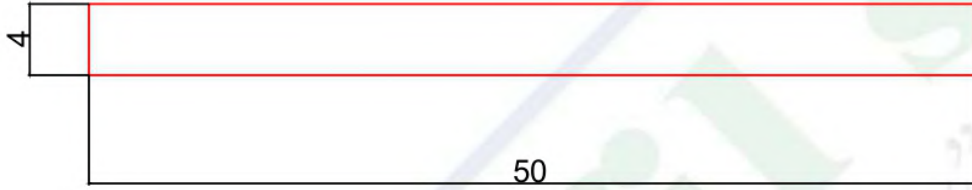

PVC BİTİŞ YERİ

(Pvc ending area)

BÖLÜM SORUMLUSU NEJDET ALTINTOPRAK	BU ÇİZİM PROFİLSE - SİLAS ORMAN ÜRÜNLERİ'NE AİTTİR. İZİNSİZ ÇOĞALTILMAMAK VE KOPYA EDİLMEMEK ŞARTI İLE İZİN VERİLMİŞTİR.	PVC ENİ : MDF MİKTARI : PLAKADAN ÇIKAN :	KSM ÖLÇÜCÜ :	KUTU İÇİ : KUTU İÇİ ADET :
ARGE SORUMLUSU DOĞUKAN DEMİR	THIS DRAWING PROFILE - SİLAS FOREST PRODUCTS WHAT TO DO. UNLOCKED AND COPY NOT ALLOWED WITH THE WRITTEN.	GENEL TOLERANS : PROFL BOY TOLERANSI :	MATERIAL MM MDF	TARİH / DATE 10.09.2018

4 mm Profiles

PROFİLSE - SİLAS ORMAN ÜRÜNLERİ

KAĞIT ÜZERİNDEN ÖLÇÜ ALMAYINIZ !!!

Don't measurate on paper.

ÜRÜN KODU : 04*20

(Product Code)

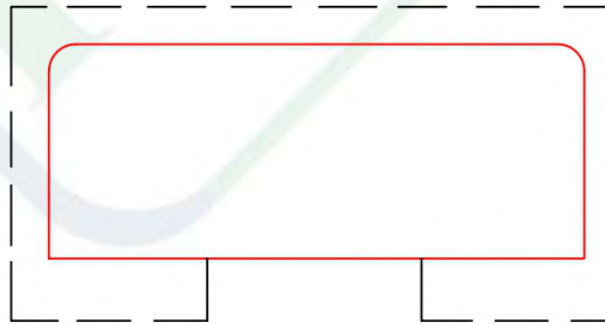

PVC BİTİŞ YERİ
(Pvc ending area)

BÖLÜM SORUMLUSU NEJDET ALTINTOPRAK	BU ÇİZİM PROFİLSE - SİLAS ORMAN ÜRÜNLERİ'NE AİTTİR. İZİNSİZ ÇOĞALTILMAMAK VE KOPYA EDİLMEMEK ŞARTI İLE İZİN VERİLMİŞTİR.	PVC ENİ : MDF MİKTARI : PLAKADAN ÇIKAN :	KSM ÖLÇÜCÜ :	KUTU İÇİ : KUTU İÇİ ADET :
ARGE SORUMLUSU DOĞUKAN DEMİR	THIS DRAWING PROFILE - SİLAS FOREST PRODUCTS WHAT TO DO. UNLOCKED AND COPY NOT ALLOWED WITH THE WRITTEN.	GENEL TOLERANS : PROFL BOY TOLERANSI :	MATERIAL MM MDF	TARİH / DATE 12.11.2018

4 mm Profiles

PROFİLSE - SİLAS ORMAN ÜRÜNLERİ

KAĞIT ÜZERİNDEN ÖLÇÜ ALMAYINIZ !!!

Don't measurate on paper.

ÜRÜN KODU : 04*18

(Product Code)

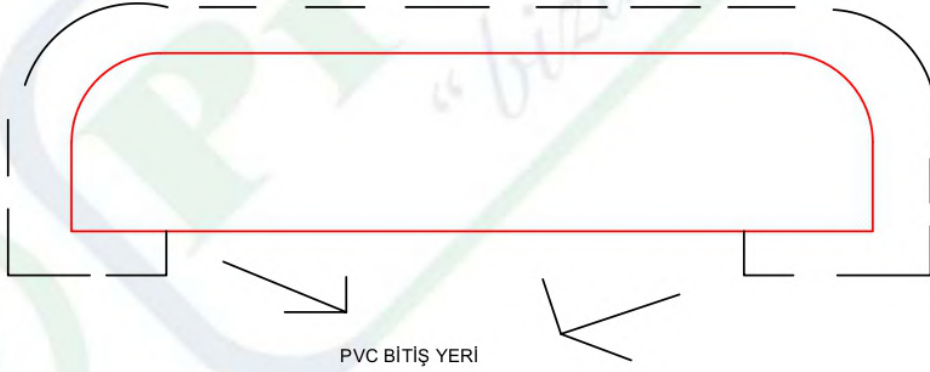

(Pvc ending area)

BÖLÜM SORUMLUSU NEJDET ALTINTOPRAK	BU ÇİZİM PROFİLSE - SİLAS ORMAN ÜRÜNLERİ'NE AİTTİR. İZİNSİZ ÇOĞALTILMAMAK VE KOPYA EDİLMEMEK ŞARTI İLE İZİN VERİLMİŞTİR.	PVC ENİ : MDF MİKTARI : PLAKADAN ÇIKAN :	KSM ÖLÇÜCÜ :	KUTU İÇİ : KUTU İÇİ ADET :
ARGE SORUMLUSU DOĞUKAN DEMİR	THIS DRAWING PROFILE - SİLAS FOREST PRODUCTS WHAT TO DO. UNLOCKED AND COPY NOT ALLOWED WITH THE WRITTEN.	GENEL TOLERANS : PROFİL BOY TOLERANSI :	MATERIAL MM MDF	TARİH / DATE 05.10.2018

6-7 mm Profiles

PROFİLSE - SİLAS ORMAN ÜRÜNLERİ

KAĞIT ÜZERİNDEN ÖLÇÜ ALMAYINIZ !!!

Don't measurate on paper.

ÜRÜN KODU: 06*30
(Product Code)



PVC BİTİŞ YERİ

(Pvc ending area)

BÖLÜM SORUMLUSU NEJDET ALTINTOPRAK	BU ÇİZİM PROFİLSE - SİLAS ORMAN ÜRÜNLERİ NE AİTTİR. İZINSİZ ÇOĞALTILMAMAK VE KOPYA EDİLMEMEK ŞARTI İLE İZİN VERİLMİŞTİR.	PVC ENİ : MDF MİKTARI : FLAKADAN ÇIKAN :	KSM ÖLÇÜCÜ :	KUTU İÇİ : KUTU İÇİ ADET :
ARGE SORUMLUSU DOĞUKAN DEMİR	THIS DRAWING PROFILE - SILAS FOREST PRODUCTS WHAT TO DO. UNLOCKED AND COPY NOT ALLOWED WITH THE WRITTEN.	GENEL TOLERANS : PROFİL BOY TOLERANSI :	MATERIAL MM MDF	TARİH / DATE 10.12.2018

6-7 mm Profiles

PROFİLSE - SİLAS ORMAN ÜRÜNLERİ

KAĞIT ÜZERİNDEN ÖLÇÜ ALMAYINIZ !!!

Don't measurate on paper.

ÜRÜN KODU : 06*18

(Product Code)

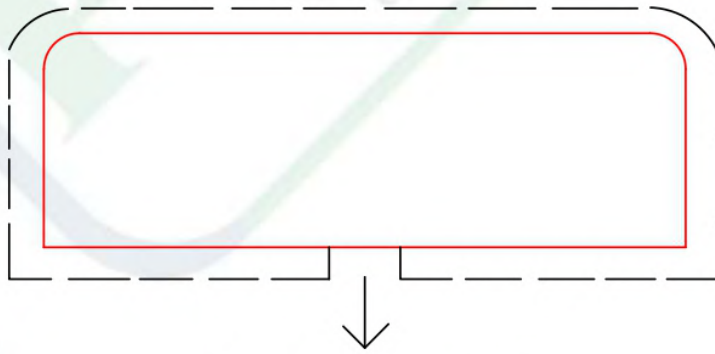
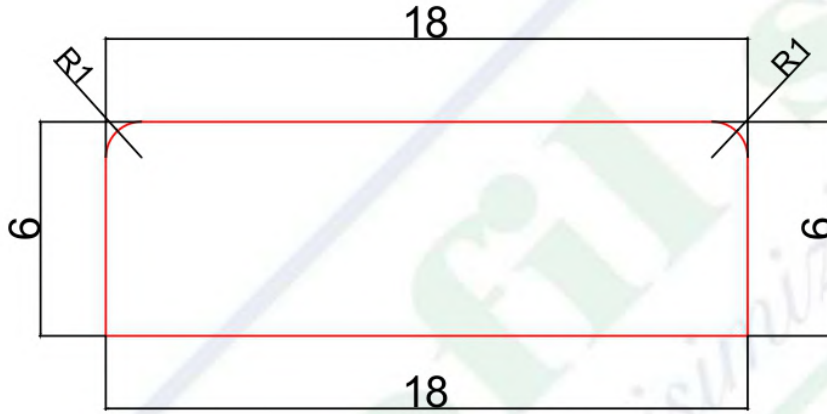

PVC BITİŞ YERİ

(Pvc ending area)

BÖLÜM SORUMLUSU NEJDET ALTINTOPRAK	BU ÇİZİM PROFİLSE - SİLAS ORMAN ÜRÜNLERİ'NE AİTTİR. İZİNSİZ ÇOĞALTILMAMAK VE KOPYA EDİLMEMEK ŞARTI İLE İZİN VERİLMİŞTİR.	PVC ENİ : MDF MİKTARI : PLAKADAN ÇIKAN :	KSM ÖLÇÜCÜ :	KUTU İÇİ : KUTU İÇİ ADET :
ARGE SORUMLUSU DOĞUKAN DEMİR	THIS DRAWING PROFILE - SİLAS FOREST PRODUCTS WHAT TO DO. UNLOCKED AND COPY NOT ALLOWED WITH THE WRITTEN.	GENEL TOLERANS : PROFİL BOY TOLERANSI :	MATERIAL MM MDF	TARİH / DATE 01.03.2019

6-7 mm Profiles

PROFİLSE - SİLAS ORMAN ÜRÜNLERİ

KAĞIT ÜZERİNDEN ÖLÇÜ ALMAYINIZ !!!
Don't measure on paper.

ÜRÜN KODU : 06*25
(Product Code)

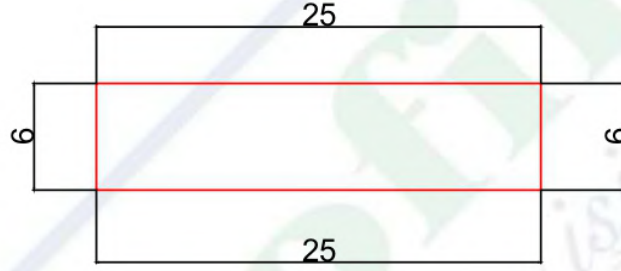

(Pvc ending area)

BÖLÜM SORUMLUSU NEJDET ALTINTOPRAK	BU ÇİZİM PROFİLSE - SİLAS ORMAN ÜRÜNLERİ'NE AİTTİR. İZİNSİZ ÇOĞALTILMAMAK VE KOPYA EDİLMEKEMEK ŞARTI İLE İZİN VERİLMİŞTİR.	PVC ENİ : MDF MİKTARI : PLAKADAN ÇIKAN :	KSM ÖLÇÜCÜ :	KUTU İÇİ : KUTU İÇİ ADET :
ARGE SORUMLUSU DOĞUKAN DEMİR	THIS DRAWING PROFILE - SİLAS FOREST PRODUCTS WHAT TO DO. UNLOCKED AND COPY NOT ALLOWED WITH THE WRITTEN.	GENEL TOLERANS : PROFİL BOY TOLERANSI :	MATERİYAL MM MDF	TARİH / DATE 19.11.2018

6-7 mm Profiles

PROFİLSE - SİLAS ORMAN ÜRÜNLERİ

KAĞIT ÜZERİNDEN ÖLÇÜ ALMAYINIZ !!!

Don't measurate on paper.

ÜRÜN KODU : 06*12

(Product Code)

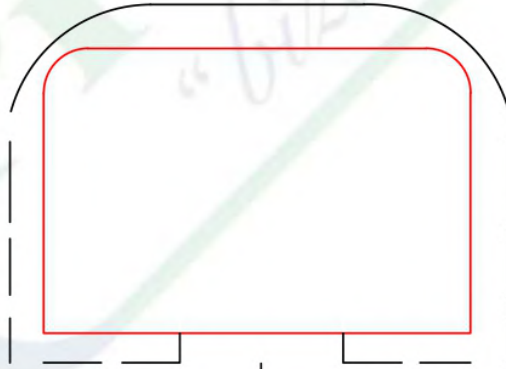
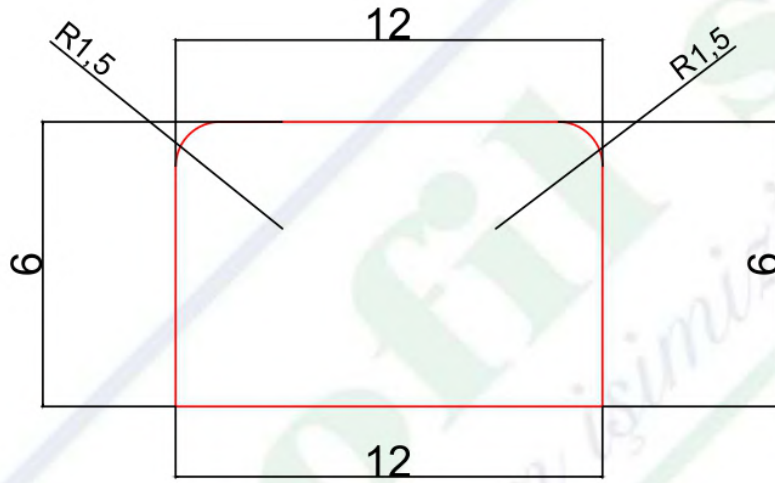

PVC BİTİŞ YERİ

(Pvc ending area)

BÖLÜM SORUMLUSU NEJDET ALTINTOPRAK	BU ÇİZİM PROFİLSE - SİLAS ORMAN ÜRÜNLERİ'NE AİTTİR. İZINSİZ ÇOĞALTILMAMAK VE KOPYA EDİLMEMEK ŞARTI İLE İZİN VERİLMİŞTİR.	PVC ENİ : MDF MİKTARI : PLAKADAN ÇIKAN :	KSM ÖLÇÜCÜ :	KUTU İÇİ : KUTU İÇİ ADET :
ARGE SORUMLUSU DOĞUKAN DEMİR	THIS DRAWING PROFILE - SİLAS FOREST PRODUCTS WHAT TO DO. UNLOCKED AND COPY NOT ALLOWED WITH THE WRITTEN.	GENEL TOLERANS : PROFİL BOY TOLERANSI :	MATERIAL MM MDF	TARİH / DATE 22.02.2019

6-7 mm Profiles

PROFİLSE - SİLAS ORMAN ÜRÜNLERİ

KAĞIT ÜZERİNDEN ÖLÇÜ ALMAYINIZ !!!
Don't measurate on paper.

ÜRÜN KODU : 06*09
(Product Code)

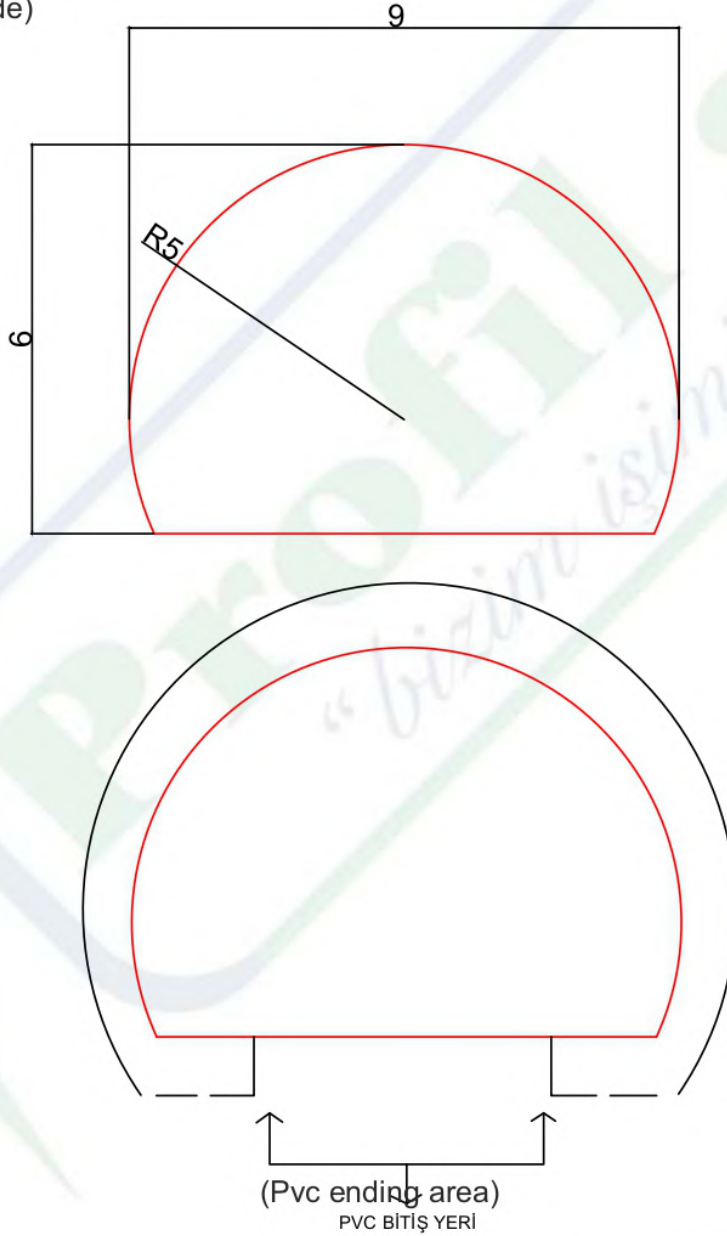

BÖLÜM SORUMLUSU NEJDET ALTINTOPRAK	BU ÇİZİM PROFİLSE - SİLAS ORMAN ÜRÜNLERİ'NE AİTTİR. İZİNSİZ ÇOĞALTILMAMAK VE KOPYA EDİLMEK ŞARTI İLE İZİN VERİLMİŞTİR.	PVC ENİ : MDF MIKTARI : PLAKADAN ÇIKAN :	KSM ÖLÇÜCÜ :	KUTU İÇİ : KUTU İÇİ ADET :
ARGE SORUMLUSU DOĞUKAN DEMİR	THIS DRAWING PROFILE - SİLAS FOREST PRODUCTS WHAT TO DO. UNLOCKED AND COPY NOT ALLOWED WITH THE WRITTEN.	GENEL TOLERANS : PROFİL BOY TOLERANSI :	MATERIAL MM MDF	TARİH / DATE 04.10.2018

6-7 mm Profiles

PROFİLSE - SİLAS ORMAN ÜRÜNLERİ

KAĞIT ÜZERİNDEN ÖLÇÜ ALMAYINIZ !!!
Don't measure on paper.

ÜRÜN KODU : 07*39-14

(Product Code)

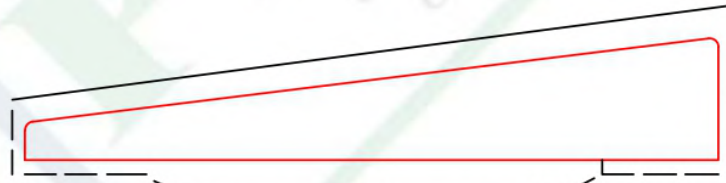
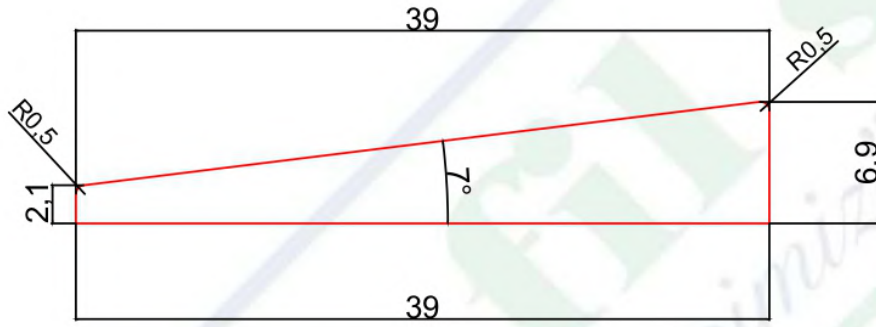

PVC BİTİŞ YERİ
(Pvc ending area)

BÖLÜM SORUMLUSU NEJDET ALTINTOPRAK	BU ÇİZİM PROFİLSE - SİLAS ORMAN ÜRÜNLERİ'NE AİTTİR. İZİNSİZ ÇOĞALTILMAMAK VE KOPYA EDİLMEMEK ŞARTI İLE İZİN VERİLMİŞTİR.	PVC ENİ : MDF MİKTARI : PLAKADAN ÇIKAN :	KSM ÖLÇÜCÜ :	KUTU İÇİ : KUTU İÇİ ADET :
ARGE SORUMLUSU DOĞUKAN DEMİR	THIS DRAWING PROFILE - SİLAS FOREST PRODUCTS WHAT TO DO. UNLOCKED AND COPY NOT ALLOWED WITH THE WRITTEN.	GENEL TOLERANS : PROFİL BOY TOLERANSI :	MATERİYAL MM MDF	TARİH / DATE 18.01.2019

6-7 mm Profiles

PROFİLSE - SİLAS ORMAN ÜRÜNLERİ

KAĞIT ÜZERİNDEN ÖLÇÜ ALMAYINIZ !!!
Don't measure on paper.

ÜRÜN KODU : 07*30
(Product Code)

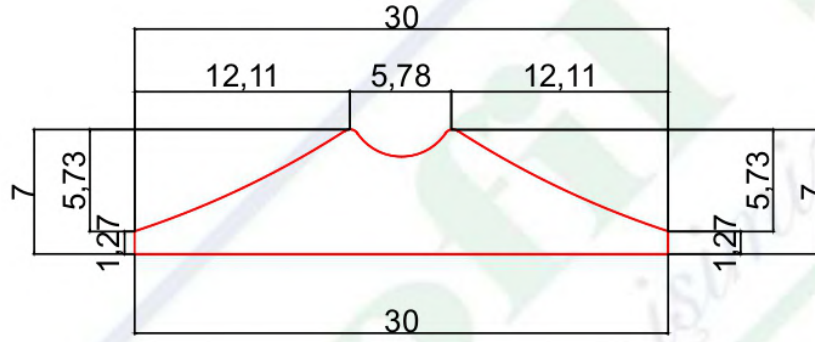

BÖLÜM SORUMLUSU NEJDET ALTINTOPRAK	BU ÇİZİM PROFİLSE - SİLAS ORMAN ÜRÜNLERİ'NE AİTTİR. İZINSİZ ÇOĞALTILMAMAK VE KOPYA EDİLMEMEK ŞARTI İLE İZİN VERİLMİŞTİR.	PVC ENİ : MDF MİKTARI : PLAKADAN ÇIKAN :	KSM ÖLÇÜCÜ :	KUTU İÇİ : KUTU İÇİ ADET :
ARGE SORUMLUSU DOĞUKAN DEMİR	THIS DRAWING PROFILE - SİLAS FOREST PRODUCTS WHAT TO DO. UNLOCKED AND COPY NOT ALLOWED WITH THE WRITTEN.	GENEL TOLERANS : PROFİL BOY TOLERANSI :	MATERİYAL MM MDF	TARİH / DATE 3.01.2019

8 mm Profiles

PROFİLSE - SİLAS ORMAN ÜRÜNLERİ

KAĞIT ÜZERİNDEN ÖLÇÜ ALMAYINIZ !!!
Don't measure on paper.

ÜRÜN KODU : 08*60-01

(Product Code)

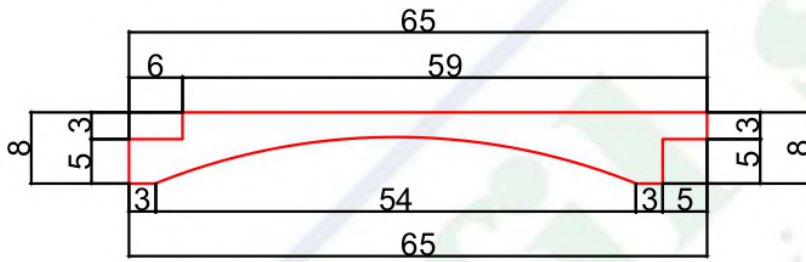

(Pvc ending area)

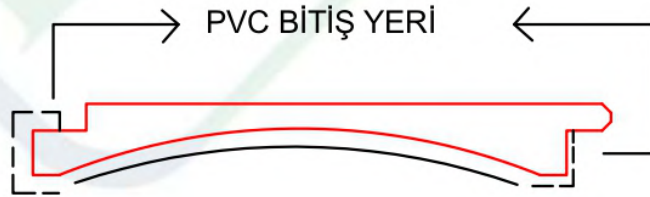

BÖLÜM SORUMLUSU NEJDET ALTINTOPRAK	BU ÇİZİM PROFİLSE - SİLAS ORMAN ÜRÜNLERİ'NE AİTTİR. İZINSİZ ÇOĞALTILMAMAK VE KOPYA EDİLMEMEĞİ ŞARTI İLE İZİN VERİLMİŞTİR.	PVC ENİ : MDF MİKTARI : PLAKADAN ÇIKAN :	KSM ÖLÇÜCÜ :	KUTU İÇİ : KUTU İÇİ ADET :
ARGE SORUMLUSU DOĞUKAN DEMİR	THIS DRAWING PROFILE - SİLAS FOREST PRODUCTS WHAT TO DO. UNLOCKED AND COPY NOT ALLOWED WITH THE WRITTEN.	GENEL TOLERANS : PROFİL BOY TOLERANSI :	MATERİYAL MM MDF	TARİH / DATE 04.10.2018

8 mm Profiles

PROFİLSE - SİLAS ORMAN ÜRÜNLERİ

KAĞIT ÜZERİNDEN ÖLÇÜ ALMAYINIZ !!!

Don't measurate on paper.

ÜRÜN KODU : 08*60-02

(Product Code)

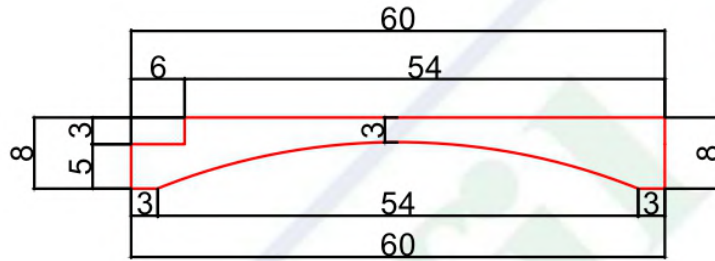

(Pvc ending area)



BÖLÜM SORUMLUSU NEJDET ALTINTOPRAK	BU ÇİZİM PROFİLSE - SİLAS ORMAN ÜRÜNLERİ'NE AİTTİR. İZINSİZ ÇOĞALTILMAMAK VE KOPYA EDİLMEMEK ŞARTI İLE İZİN VERİLMİŞTİR.	PVC ENİ : MDF MİKTARI : PLAKADAN ÇIKAN :	KSM ÖLÇÜCÜ :	KUTU İÇİ : KUTU İÇİ ADET :
ARGE SORUMLUSU DOĞUKAN DEMİR	THIS DRAWING PROFILE - SİLAS FOREST PRODUCTS WHAT TO DO. UNLOCKED AND COPY NOT ALLOWED WITH THE WRITTEN.	GENEL TOLERANS : PROFİL BOY TOLERANSI :	MATERİYAL MM MDF	TARİH / DATE 04.10.2018

8 mm Profiles

PROFİLSE - SİLAS ORMAN ÜRÜNLERİ

KAĞIT ÜZERİNDEN ÖLÇÜ ALMAYINIZ !!!
Don't measure on paper.

ÜRÜN KODU : 08*90
(Product Code)

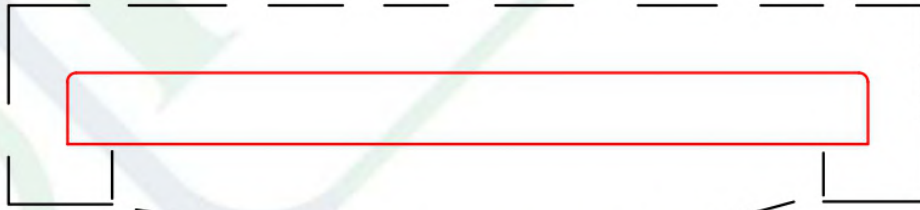
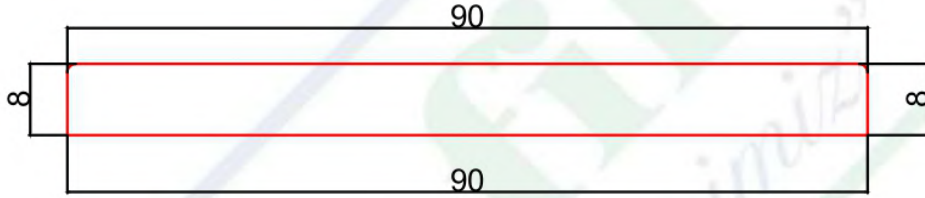

PVC BİTİŞ YERİ
(Pvc ending area)

BÖLÜM SORUMLUSU NEJDET ALTINTOPRAK	BU ÇİZİM PROFİLSE - SİLAS ORMAN ÜRÜNLERİ'NE AİTTİR. İZINSİZ ÇOĞALTILMAMAK VE KOPYA EDİLMEMEK ŞARTI İLE İZİN VERİLMİŞTİR.	PVC ENİ : MDF MİKTARI : PLAKADAN ÇIKAN :	KSM ÖLÇÜCÜ :	KUTU İÇİ : KUTU İÇİ ADET :
ARGE SORUMLUSU DOĞUKAN DEMİR	THIS DRAWING PROFILE - SİLAS FOREST PRODUCTS WHAT TO DO. UNLOCKED AND COPY NOT ALLOWED WITH THE WRITTEN.	GENEL TOLERANS : PROFİL BOY TOLERANSI :	MATERİYAL MM MDF	TARİH / DATE 04.10.2018

8 mm Profiles

PROFİLSE - SİLAS ORMAN ÜRÜNLERİ

KAĞIT ÜZERİNDEN ÖLÇÜ ALMAYINIZ !!!
Don't measurate on paper.

ÜRÜN KODU : 09*18
(Product Code)

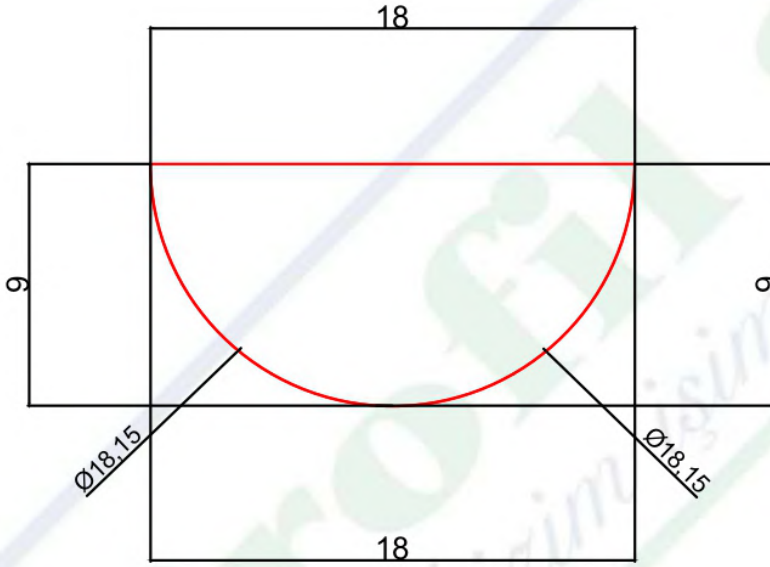

BÖLÜM SORUMLUSU NEJDET ALTINTOPRAK	BU ÇİZİM PROFİLSE - SİLAS ORMAN ÜRÜNLERİ'NE AİTTİR. İZINSİZ ÇOĞALTILMAMAK VE KOPYA EDİLMEK ŞARTI İLE İZİN VERİLMİŞTİR.	PVC ENİ : MDF MİKTARI : PLAKADAN ÇIKAN :	KSM ÖLÇÜCÜ :	KUTU İÇİ : KUTU İÇİ ADET :
ARGE SORUMLUSU DOĞUKAN DEMİR	THIS DRAWING PROFILE - SİLAS FOREST PRODUCTS WHAT TO DO. UNLOCKED AND COPY NOT ALLOWED WITH THE WRITTEN.	GENEL TOLERANS : PROFİL BOY TOLERANSI :	MATERİYAL MM MDF	TARİH / DATE 25.12.2018

8 mm Profiles

PROFİLSE - SİLAS ORMAN ÜRÜNLERİ

KAĞIT ÜZERİNDEN ÖLÇÜ ALMAYINIZ !!!
Don't measure on paper.

ÜRÜN KODU : 08*20

(Product Code)

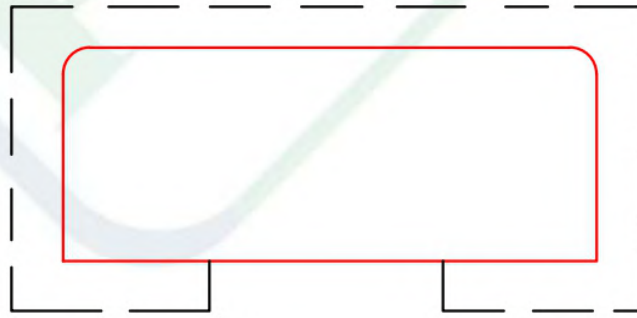

PVC BİTİŞ YERİ

(Pvc ending area)

BÖLÜM SORUMLUSU NEJDET ALTINTOPRAK	BU ÇİZİM PROFİLSE - SİLAS ORMAN ÜRÜNLERİ'NE AİTTİR. İZINSİZ ÇOĞALTILMAMAK VE KOPYA EDİLMEKEMEK ŞARTI İLE İZİN VERİLMİŞTİR.	PVC ENİ : MDF MİKTARI : PLAKADAN ÇIKAN :	KSM ÖLÇÜCÜ :	KUTU İÇİ : KUTU İÇİ ADET :
ARGE SORUMLUSU DOĞUKAN DEMİR	THIS DRAWING PROFILE - SİLAS FOREST PRODUCTS WHAT TO DO. UNLOCKED AND COPY NOT ALLOWED WITH THE WRITTEN.	GENEL TOLERANS : PROFİL BOY TOLERANSI :	MATERİYAL MM MDF	TARİH / DATE 12.11.2018

8 mm Profiles

PROFİLSE - SİLAS ORMAN ÜRÜNLERİ

KAĞIT ÜZERİNDEN ÖLÇÜ ALMAYINIZ !!!
Don't measure on paper.

ÜRÜN KODU : 08*16
(Product Code)

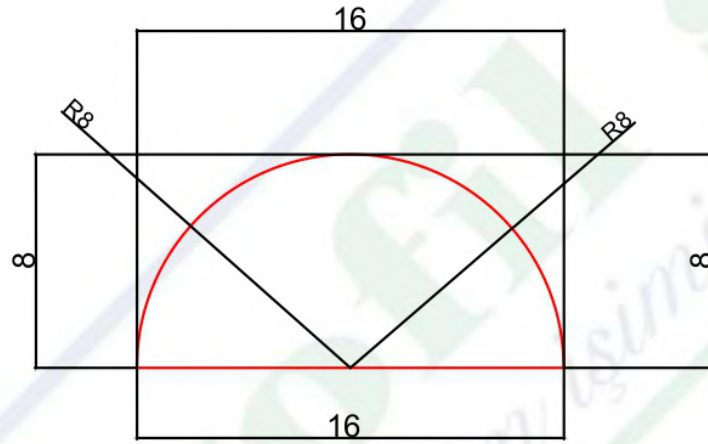

BÖLÜM SORUMLUSU NEJDET ALTINTOPRAK	BU ÇİZİM PROFİLSE - SİLAS ORMAN ÜRÜNLERİ'NE AİTTİR. İZINSİZ ÇOĞALTILMAMAK VE KOPYA EDİLMEMEK ŞARTI İLE İZİN VERİLMİŞTİR.	PVC ENİ : MDF MİKTARI : PLAKADAN ÇIKAN :	KSM ÖLÇÜCÜ :	KUTU İÇİ : KUTU İÇİ ADET :
ARGE SORUMLUSU DOĞUKAN DEMİR	THIS DRAWING PROFILE - SİLAS FOREST PRODUCTS WHAT TO DO. UNLOCKED AND COPY NOT ALLOWED WITH THE WRITTEN.	GENEL TOLERANS : PROFİL BOY TOLERANSI :	MATERIAL MM MDF	TARİH / DATE 3.01.2019

8 mm Profiles

PROFİLSE - SİLAS ORMAN ÜRÜNLERİ

KAĞIT ÜZERİNDEN ÖLÇÜ ALMAYINIZ !!!
Don't measure on paper.

ÜRÜN KODU : 08*09
(Product Code)

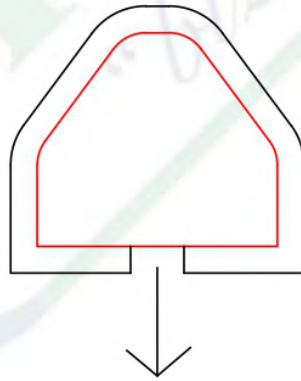
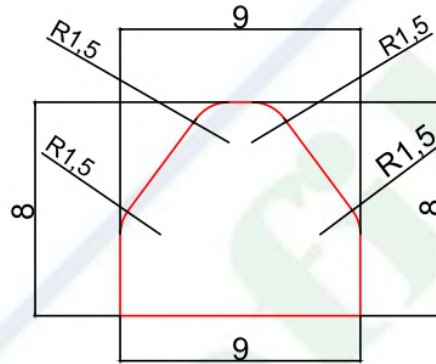

PVC BİTİŞ YERİ
(Pvc ending area)

BÖLÜM SORUMLUSU NEJDET ALTINTOPRAK	BU ÇİZİM PROFİLSE - SİLAS ORMAN ÜRÜNLERİ'NE AİTTİR. İZİNSİZ ÇOĞALTILMAMAK VE KOPYA EDİLMEMEK ŞARTI İLE İZİN VERİLMİŞTİR.	PVC ENİ : MDF MİKTARI : PLAKADAN ÇIKAN :	KSM ÖLÇÜCÜ :	KUTU İÇİ : KUTU İÇİ ADET :
ARGE SORUMLUSU DOĞUKAN DEMİR	THIS DRAWING PROFILE - SİLAS FOREST PRODUCTS WHAT TO DO. UNLOCKED AND COPY NOT ALLOWED WITH THE WRITTEN.	GENEL TOLERANS : PROFİL BOY TOLERANSI :	MATERIAL MM MDF	TARİH / DATE 07.01.2019

8 mm Profiles

PROFİLSE - SİLAS ORMAN ÜRÜNLERİ

KAĞIT ÜZERİNDEN ÖLÇÜ ALMAYINIZ !!!
Don't measurate on paper.

ÜRÜN KODU : 08*18
(Product Code)

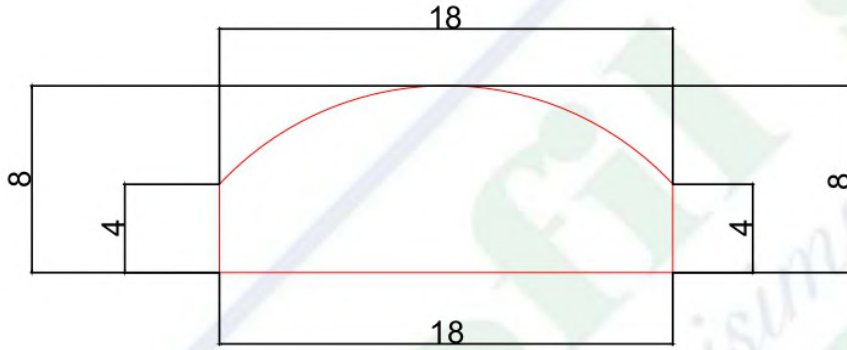

PVC

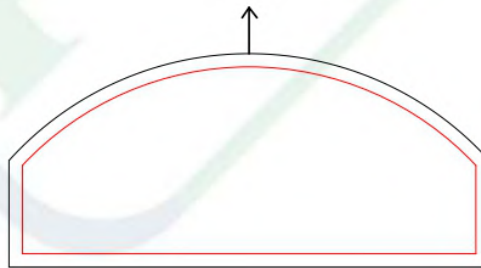

BÖLÜM SORUMLUSU NEJDET ALTINTOPRAK	BU ÇİZİM PROFİLSE - SİLAS ORMAN ÜRÜNLERİ'NE AİTTİR. İZİNSİZ ÇOĞALTILMAMAK VE KOPYA EDİLMEKEMEK ŞARTI İLE İZİN VERİLMİŞTİR.	PVC ENİ : MDF MIKTARI : PLAKADAN ÇIKAN :	KSM ÖLÇÜCÜ :	KUTU İÇİ : KUTU İÇİ ADET :
ARGE SORUMLUSU DOĞUKAN DEMİR	THIS DRAWING PROFILE - SİLAS FOREST PRODUCTS WHAT TO DO. UNLOCKED AND COPY NOT ALLOWED WITH THE WRITTEN.	GENEL TOLERANS : PROFL BOY TOLERANSI :	MATERIAL MM MDF	TARİH / DATE 16.01.2019

8 mm Profiles

PROFİLSE - SİLAS ORMAN ÜRÜNLERİ

KAĞIT ÜZERİNDEN ÖLÇÜ ALMAYINIZ !!!

Don't measurate on paper.

ÜRÜN KODU : 08*56

(Product Code)

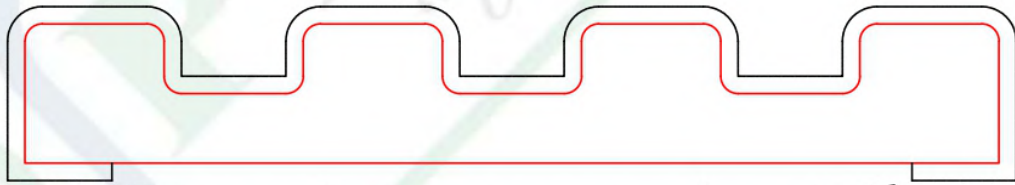
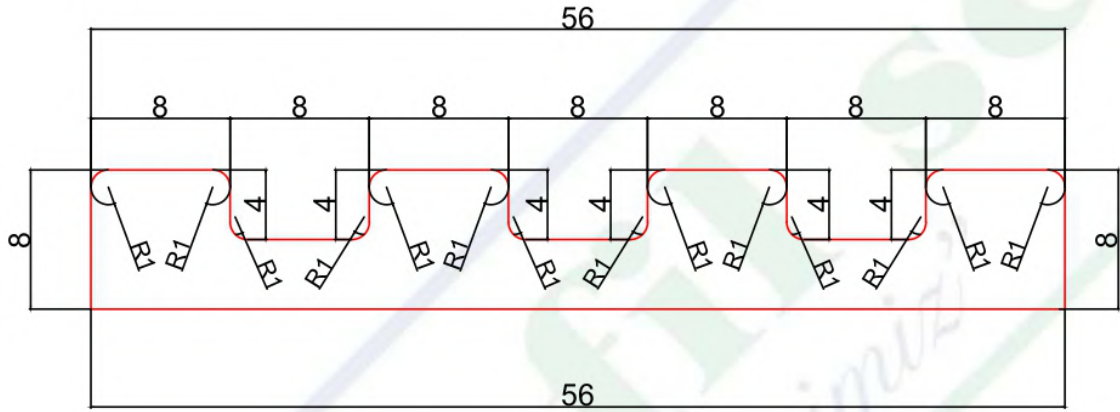

PVC BİTİŞ YERİ

(Pvc ending area)

BÖLÜM SORUMLUSU NEJDET ALTINTOPRAK	BU ÇİZİM PROFİLSE - SİLAS ORMAN ÜRÜNLERİ NE AİTTİR. İZİNSİZ ÇOĞALTILMAMAK VE KOPYA EDİLMEMEK ŞARTI İLE İZİN VERLMİŞTİR.	PVC ENİ : MDF MİKTARI : PLAKADAN ÇIKAN :	KSM ÖLÇÜCÜ :	KUTU İÇİ : KUTU İÇİ ADET :
ARGE SORUMLUSU DOĞUKAN DEMİR	THIS DRAWING PROFILE - SILAS FOREST PRODUCTS WHAT TO DO. UNLOCKED AND COPY NOT ALLOWED WITH THE WRITTEN.	GENEL TOLERANS : PROFİL BOY TOLERANSI :	MATERIAL MM MDF	TARİH / DATE 4.01.2019

8 mm Profiles

PROFİLSE - SİLAS ORMAN ÜRÜNLERİ

KAĞIT ÜZERİNDEN ÖLÇÜ ALMAYINIZ !!!
Don't measurate on paper.

ÜRÜN KODU : 08*12
(Product Code)

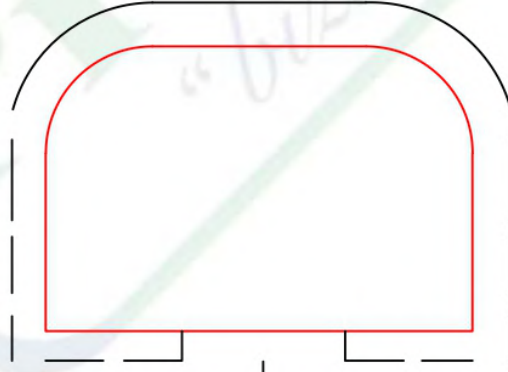
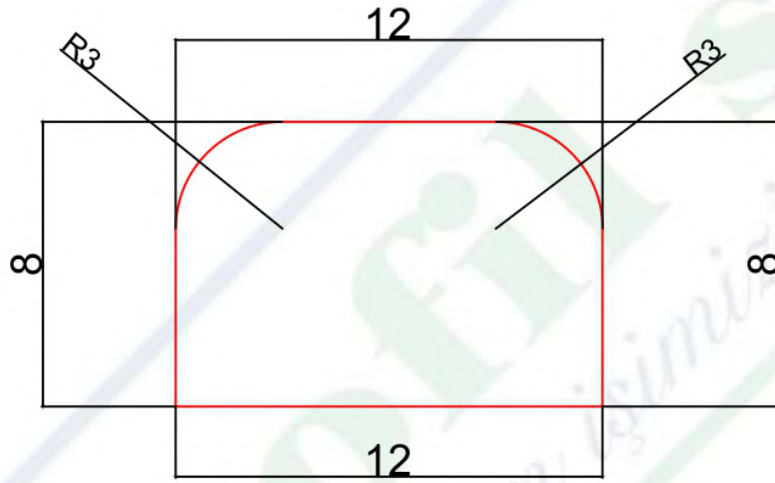

PVC BİTİŞ YERİ
(Pvc ending area)

BÖLÜM SORUMLUSU NEJDET ALTINTOPRAK	BU ÇİZİM PROFİLSE - SİLAS ORMAN ÜRÜNLERİ'NE AİTTİR. İZINSİZ ÇOĞALTILMAMAK VE KOPYA EDİLMEK ŞARTI İLE İZİN VERİLMİŞTİR.	PVC ENİ : MDF MİKTARI : PLAKADAN ÇIKAN :	KSM ÖLÇÜCÜ :	KUTU İÇİ : KUTU İÇİ ADET :
ARGE SORUMLUSU DOĞUKAN DEMİR	THIS DRAWING PROFILE - SİLAS FOREST PRODUCTS WHAT TO DO. UNLOCKED AND COPY NOT ALLOWED WITH THE WRITTEN.	GENEL TOLERANS : PROFİL BOY TOLERANSI :	MATERİYAL MM MDF	TARİH / DATE 16.01.2019

8 mm Profiles

PROFİLSE - SİLAS ORMAN ÜRÜNLERİ

KAĞIT ÜZERİNDEN ÖLÇÜ ALMAYINIZ !!!
Don't measure on paper.

ÜRÜN KODU : 08*18
(Product Code)

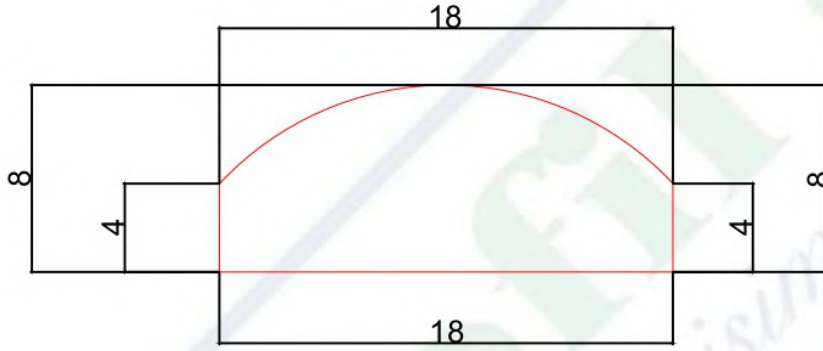

PVC

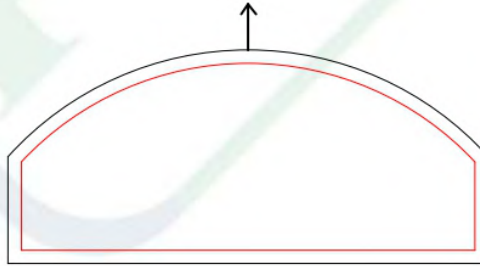

BÖLÜM SORUMLUSU NEJDET ALTINTOPRAK	BU ÇİZİM PROFİLSE - SİLAS ORMAN ÜRÜNLERİ'NE AİTTİR. İZINSİZ ÇOĞALTILMAMAK VE KOPYA EDİLMEMEK ŞARTI İLE İZİN VERİLMİŞTİR.	PVC ENİ : MDF MİKTARI : PLAKADAN ÇIKAN :	KSM ÖLÇÜCÜ :	KUTU İÇİ : KUTU İÇİ ADET :
ARGE SORUMLUSU DOĞUKAN DEMİR	THIS DRAWING PROFILE - SİLAS FOREST PRODUCTS WHAT TO DO. UNLOCKED AND COPY NOT ALLOWED WITH THE WRITTEN.	GENEL TOLERANS : PROFİL BOY TOLERANSI :	MATERİYAL MM MDF	TARİH / DATE 26.11.2018

8 mm Profiles

PROFİLSE - SİLAS ORMAN ÜRÜNLERİ

KAĞIT ÜZERİNDEN ÖLÇÜ ALMAYINIZ !!!

Don't measurate on paper.

ÜRÜN KODU : 08*27
(Product Code)

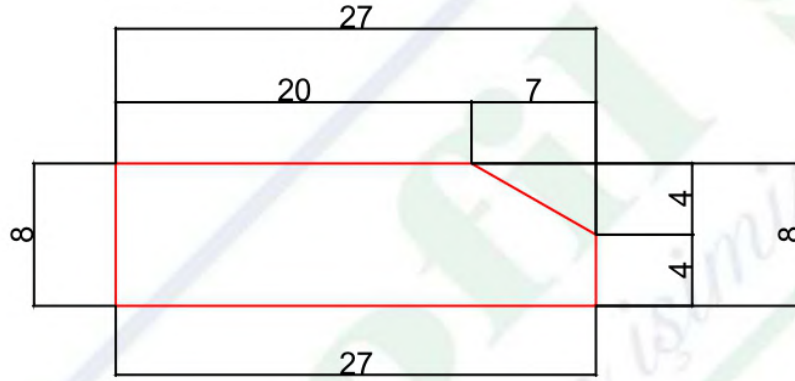

PVC BİTİŞ YERİ

(Pvc ending area)

BÖLÜM SORUMLUSU NEJDET ALTINTOPRAK	BU ÇİZİM PROFİLSE - SİLAS ORMAN ÜRÜNLERİ'NE AİTTİR. İZINSİZ ÇOĞALTILMAMAK VE KOPYA EDİLMEMEK ŞARTI İLE İZİN VERİLMİŞTİR.	PVC ENİ : MDF MİKTARI : PLAKADAN ÇIKAN :	KSM ÖLÇÜCÜ :	KUTU İÇİ : KUTU İÇİ ADET :
ARGE SORUMLUSU DOĞUKAN DEMİR	THIS DRAWING PROFILE - SİLAS FOREST PRODUCTS WHAT TO DO. UNLOCKED AND COPY NOT ALLOWED WITH THE WRITTEN.	GENEL TOLERANS : PROFL BOY TOLERANSI :	MATERIAL MM MDF	TARİH / DATE 21.11.2018

8 mm Profiles

PROFİLSE - SİLAS ORMAN ÜRÜNLERİ

KAĞIT ÜZERİNDEN ÖLÇÜ ALMAYINIZ !!!
Don't measure on paper.

ÜRÜN KODU : 08*16
(Product Code)

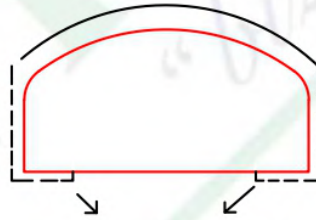
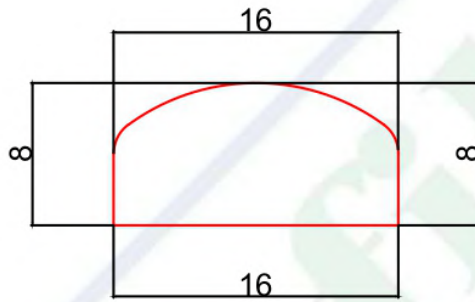

PVC BİTİŞ YERİ
(Pvc ending area)

BÖLÜM SORUMLUSU NEJDET ALTINTOPRAK	BU ÇİZİM PROFİLSE - SİLAS ORMAN ÜRÜNLERİ'NE AİTTİR. İZINSİZ ÇOĞALTILMAMAK VE KOPYA EDİLMEMEK ŞARTI İLE İZİN VERİLMİŞTİR.	PVC ENİ : MDF MİKTARI : PLAKADAN ÇIKAN :	KSM ÖLÇÜCÜ :	KUTU İÇİ : KUTU İÇİ ADET :
ARGE SORUMLUSU DOĞUKAN DEMİR	THIS DRAWING PROFILE - SİLAS FOREST PRODUCTS WHAT TO DO. UNLOCKED AND COPY NOT ALLOWED WITH THE WRITTEN.	GENEL TOLERANS : PROFİL BOY TOLERANSI :	MATERİYAL MM MDF	TARİH / DATE 21.11.2018

8 mm Profiles

PROFİLSE - SİLAS ORMAN ÜRÜNLERİ

KAĞIT ÜZERİNDEN ÖLÇÜ ALMAYINIZ !!!
Don't measure on paper.

ÜRÜN KODU : 08*90
(Product Code)

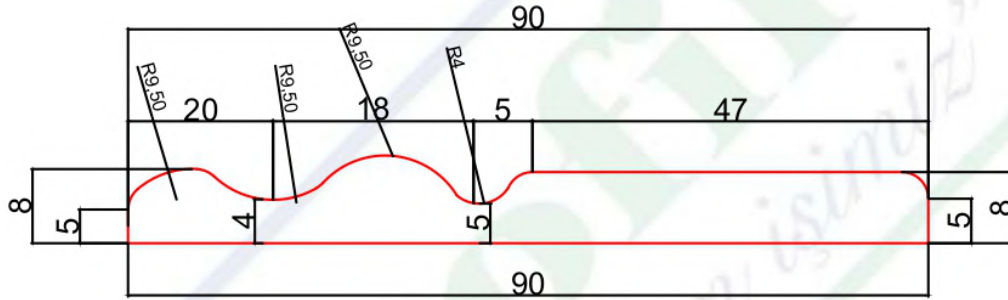

(Pvc ending area)

BÖLÜM SORUMLUSU NEJDET ALTINTOPRAK	BU ÇİZİM PROFİLSE - SİLAS ORMAN ÜRÜNLERİ'NE AİTTİR. İZİNSİZ ÇOĞALTILMAMAK VE KOPYA EDİLMEKEMEK ŞARTI İLE İZİN VERİLMİŞTİR.	PVC ENİ : MDF MİKTARI : PLAKADAN ÇIKAN :	KSM ÖLÇÜCÜ :	KUTU İÇİ : KUTU İÇİ ADET :
ARGE SORUMLUSU DOĞUKAN DEMİR	THIS DRAWING PROFILE - SİLAS FOREST PRODUCTS WHAT TO DO. UNLOCKED AND COPY NOT ALLOWED WITH THE WRITTEN.	GENEL TOLERANS : PROFİL BOY TOLERANSI :	MATERİYAL MM MDF	TARİH / DATE 21.11.2018

8 mm Profiles

PROFİLSE - SİLAS ORMAN ÜRÜNLERİ

KAĞIT ÜZERİNDEN ÖLÇÜ ALMAYINIZ !!!
Don't measure on paper.

ÜRÜN KODU : 08*14
(Product Code)

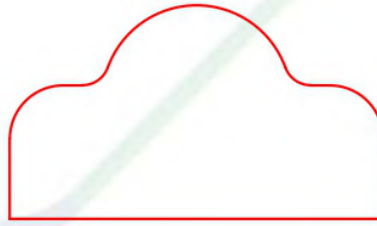
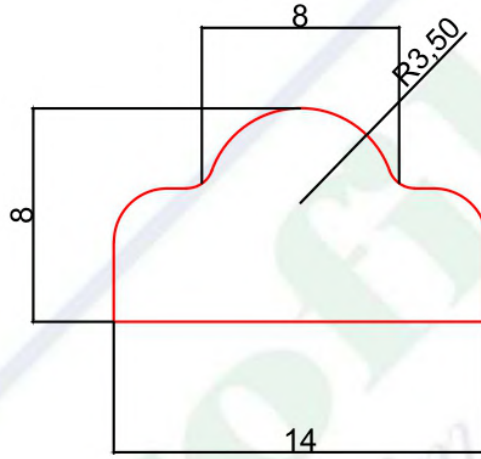

BÖLÜM SORUMLUSU NEJDET ALTINTOPRAK	BU ÇİZİM PROFİLSE - SİLAS ORMAN ÜRÜNLERİ'NE AİTTİR. İZİNSİZ ÇOĞALTILMAMAK VE KOPYA EDİLMEMEK ŞARTI İLE İZİN VERİLMİŞTİR.	PVC ENİ : MDF MİKTARI : PLAKADAN ÇIKAN :	KSM ÖLÇÜCÜ :	KUTU İÇİ : KUTU İÇİ ADET :
ARGE SORUMLUSU DOĞUKAN DEMİR	THIS DRAWING PROFILE - SİLAS FOREST PRODUCTS WHAT TO DO. UNLOCKED AND COPY NOT ALLOWED WITH THE WRITTEN.	GENEL TOLERANS : PROFİL BOY TOLERANSI :	MATERİYAL MM MDF	TARİH / DATE 03.12.2018

8 mm Profiles

PROFİLSE - SİLAS ORMAN ÜRÜNLERİ

KAĞIT ÜZERİNDEN ÖLÇÜ ALMAYINIZ !!!
Don't measurate on paper.

ÜRÜN KODU : 08*40
(Product Code)

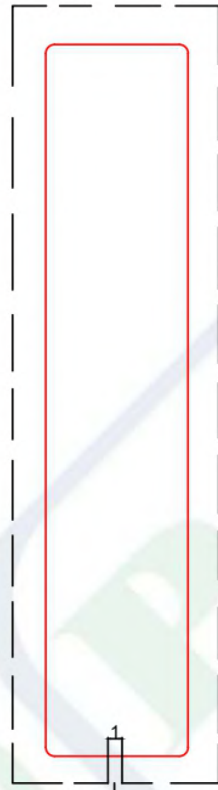

PVC BİTİŞ YERİ
(Pvc ending area)

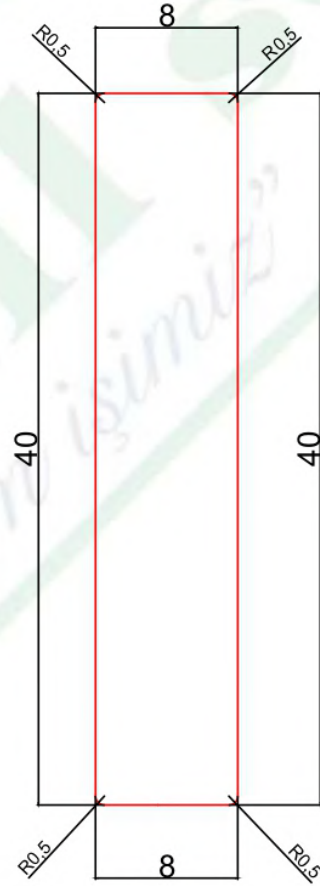

BÖLÜM SORUMLUSU NEJDET ALTINTOPRAK	BU ÇİZİM PROFİLSE - SİLAS ORMAN ÜRÜNLERİ'NE AİTTİR. İZİNSİZ ÇOĞALTILMAMAK VE KOPYA EDİLMEKEMEK ŞARTI İLE İZİN VERİLMİŞTİR.	PVC ENİ : MDF MİKTARI : PLAKADAN ÇIKAN :	KSM ÖLÇÜCÜ :	KUTU İÇİ : KUTU İÇİ ADET :
ARGE SORUMLUSU DOĞUKAN DEMİR	THIS DRAWING PROFILE - SİLAS FOREST PRODUCTS WHAT TO DO. UNLOCKED AND COPY NOT ALLOWED WITH THE WRITTEN.	GENEL TOLERANS : PROFİL BOY TOLERANSI :	MATERIAL MM MDF	TARİH / DATE 10.12.2018

8 mm Profiles

PROFİLSE - SİLAS ORMAN ÜRÜNLERİ

KAĞIT ÜZERİNDEN ÖLÇÜ ALMAYINIZ !!!

Don't measurate on paper.

ÜRÜN KODU : 08*20

(Product Code)

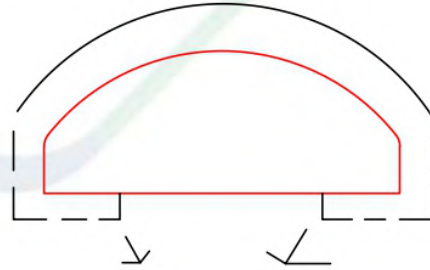
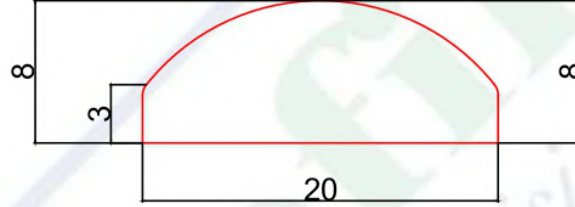

PVC BİTİŞ YERİ
(Pvc ending area)

BÖLÜM SORUMLUSU NEJDET ALTINTOPRAK	BU ÇİZİM PROFİLSE - SİLAS ORMAN ÜRÜNLERİ'NE AİTTİR. İZİNSİZ ÇOĞALTILMAMAK VE KOPYA EDİLMEKEMEK ŞARTI İLE İZİN VERİLMİŞTİR.	PVC ENİ : MDF MIKTARI : PLAKADAN ÇIKAN :	KSM ÖLÇÜCÜ :	KUTU İÇİ : KUTU İÇİ ADET :
ARGE SORUMLUSU DOĞUKAN DEMİR	THIS DRAWING PROFILE - SİLAS FOREST PRODUCTS WHAT TO DO. UNLOCKED AND COPY NOT ALLOWED WITH THE WRITTEN.	GENEL TOLERANS : PROFİL BOY TOLERANSI :	MATERIAL MM MDF	TARİH / DATE 10.10.2018

8 mm Profiles

PROFİLSE - SİLAS ORMAN ÜRÜNLERİ

KAĞIT ÜZERİNDEN ÖLÇÜ ALMAYINIZ !!!
Don't measure on paper.

ÜRÜN KODU : 08*27
(Product Code)

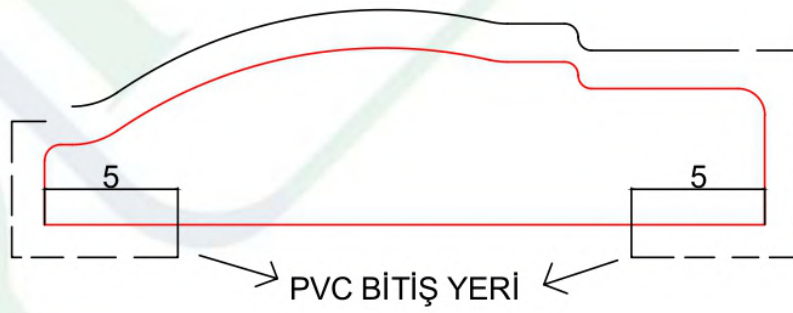
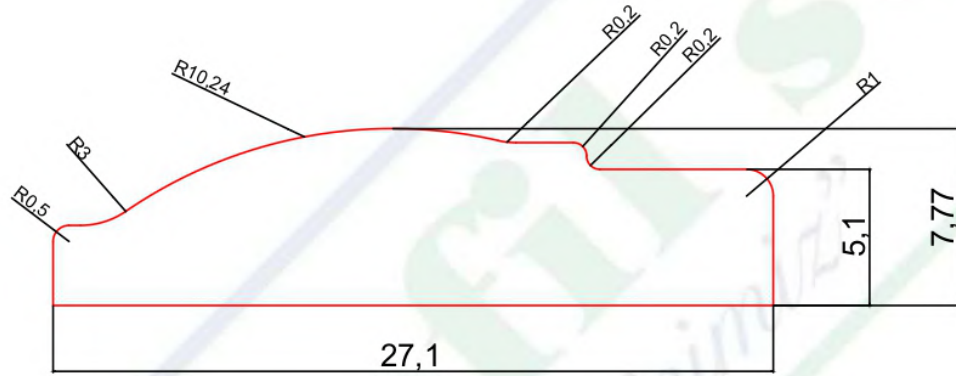

(Pvc ending area)

BÖLÜM SORUMLUSU NEJDET ALTINTOPRAK	BU ÇİZİM PROFİLSE - SİLAS ORMAN ÜRÜNLERİ'NE AİTTİR. İZİNSİZ ÇOĞALTILMAMAK VE KOPYA EDİLMEKEMEK ŞARTI İLE İZİN VERİLMİŞTİR.	PVC ENİ : MDF MİKTARI : PLAKADAN ÇIKAN :	KSM ÖLÇÜCÜ :	KUTU İÇİ : KUTU İÇİ ADET :
ARGE SORUMLUSU DOĞUKAN DEMİR	THIS DRAWING PROFILE - SİLAS FOREST PRODUCTS WHAT TO DO. UNLOCKED AND COPY NOT ALLOWED WITH THE WRITTEN.	GENEL TOLERANS : PROFİL BOY TOLERANSI :	MATERİYAL MM MDF	TARİH / DATE 10.12.2018

8 mm Profiles

PROFİLSE - SİLAS ORMAN ÜRÜNLERİ

KAĞIT ÜZERİNDEN ÖLÇÜ ALMAYINIZ !!!
Don't measurate on paper.

ÜRÜN KODU : 08*40
(Product Code)

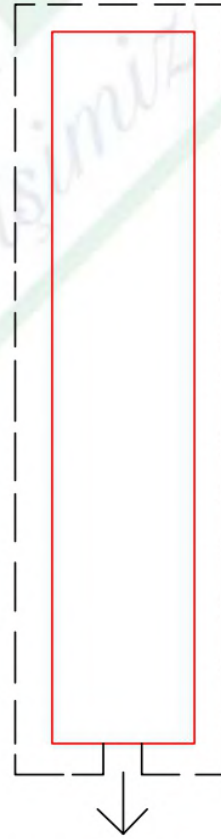

PVC BİTİŞ YERİ
(Pvc ending area)

BÖLÜM SORUMLUSU NEJDET ALTINTOPRAK	BU ÇİZİM PROFİLSE - SİLAS ORMAN ÜRÜNLERİ'NE AİTTİR. İZINSİZ ÇOĞALTILMAMAK VE KOPYA EDİLMEMEK ŞARTI İLE İZİN VERİLMİŞTİR.	PVC ENİ : MDF MİKTARI : FLAKADAN ÇIKAN :	KSM ÖLÇÜCÜ :	KUTU İÇİ : KUTU İÇİ ADET :
ARGE SORUMLUSU DOĞUKAN DEMİR	THIS DRAWING PROFILE - SİLAS FOREST PRODUCTS WHAT TO DO. UNLOCKED AND COPY NOT ALLOWED WITH THE WRITTEN.	GENEL TOLERANS : PROFİL BOY TOLERANSI :	MATERİYAL MM MDF	TARİH / DATE 10.12.2018

8 mm Profiles

PROFİLSE - SİLAS ORMAN ÜRÜNLERİ

KAĞIT ÜZERİNDEN ÖLÇÜ ALMAYINIZ !!!

ÜRÜN KODU : 08*16

(Product Code)

Don't measurate on paper.

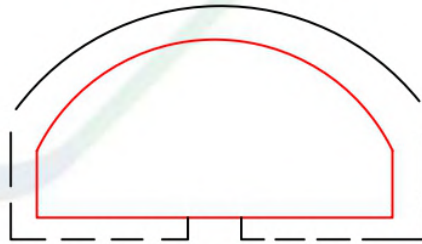
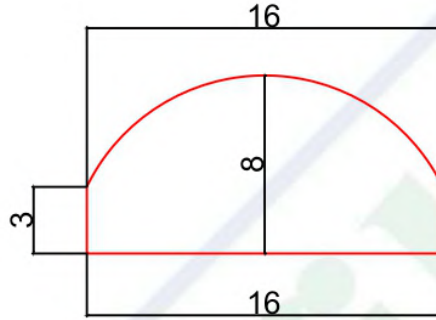

PVC BİTİŞ YERİ
(Pvc ending area)

BÖLÜM SORUMLUSU NEJDET ALTINTOPRAK	BU ÇİZİM PROFİLSE - SİLAS ORMAN ÜRÜNLERİ'NE AİTTİR. İZINSİZ ÇOĞALTILMAMAK VE KOPYA EDİLMEMEK ŞARTI İLE İZİN VERİLMİŞTİR.	PVC ENİ : MDF MIKTARI : PLAKADAN ÇIKAN :	KSM ÖLÇÜCÜ :	KUTU İÇİ : KUTU İÇİ ADET :
ARGE SORUMLUSU DOĞUKAN DEMİR	THIS DRAWING PROFILE - SİLAS FOREST PRODUCTS WHAT TO DO. UNLOCKED AND COPY NOT ALLOWED WITH THE WRITTEN.	GENEL TOLERANS : PROFİL BOY TOLERANSI :	MATERİYAL MM MDF	TARİH / DATE 12.10.2018

8 mm Profiles

PROFİLSE - SİLAS ORMAN ÜRÜNLERİ

KAGIT UZERINDEN ÖLÇÜ ALMAYINIZ !!!

Don't measurate on paper.

ÜRÜN KODU : 08*10

(Product Code)

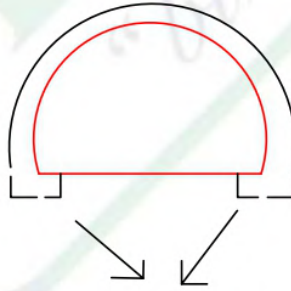
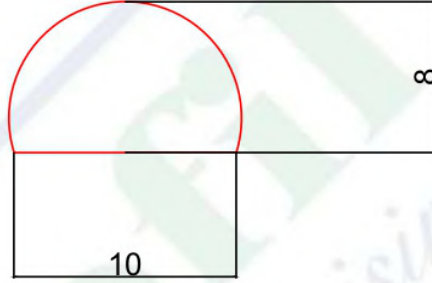

PVC BİTİŞ YERİ

(Pvc ending area)

BÖLÜM SORUMLUSU NEJDET ALTINTOPRAK	BU ÇİZİM PROFİLSE - SİLAS ORMAN ÜRÜNLERİ'NE AİTTİR. İZINSİZ ÇOĞALTILMAMAK VE KOPYA EDİLMEMEK ŞARTI İLE İZİN VERİLMİŞTİR.	PVC ENİ : MDF MİKTARI : PLAKADAN ÇIKAN :	KSM ÖLÇÜCÜ :	KUTU İÇİ : KUTU İÇİ ADET :
ARGE SORUMLUSU DOĞUKAN DEMİR	THIS DRAWING PROFILE - SILAS FOREST PRODUCTS WHAT TO DO. UNLOCKED AND COPY NOT ALLOWED WITH THE WRITTEN.	GENEL TOLERANS : PROFİL BOY TOLERANSI :	MATERIAL MM MDF	TARİH / DATE 10.09.2018

8 mm Profiles

PROFİLSE - SİLAS ORMAN ÜRÜNLERİ

KAĞIT ÜZERİNDEN ÖLÇÜ ALMAYINIZ !!!

ÜRÜN KODU : 08*80

Don't measurate on paper.

(Product Code)

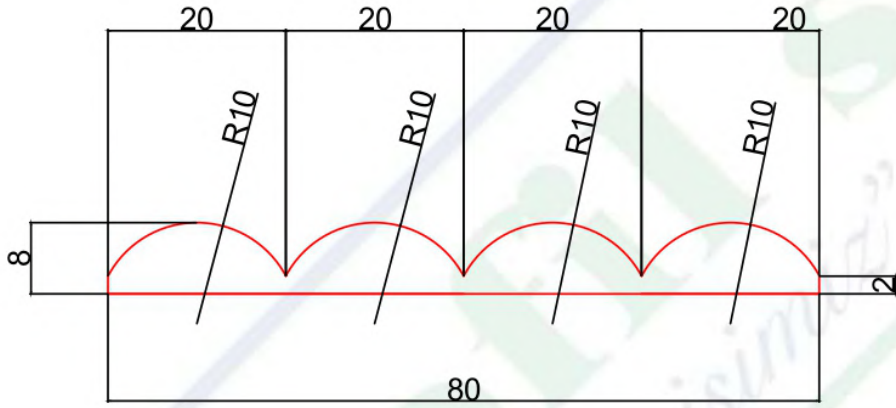

(Pvc ending area)

BÖLÜM SORUMLUSU NEJDET ALTINTOPRAK	BU ÇİZİM PROFİLSE - SİLAS ORMAN ÜRÜNLERİ'NE AİTTİR. İZİNSİZ ÇOĞALTILMAMAK VE KOPYA EDİLMEMEK ŞARTI İLE İZİN VERİLMİŞTİR.	PVC ENİ : MDF MİKTARI : PLAKADAN ÇIKAN :	KSM ÖLÇÜCÜ :	KUTU İÇİ : KUTU İÇİ ADET :
ARGE SORUMLUSU DOĞUKAN DEMİR	THIS DRAWING PROFILE - SILAS FOREST PRODUCTS WHAT TO DO. UNLOCKED AND COPY NOT ALLOWED WITH THE WRITTEN.	GENEL TOLERANS : PROFİL BOY TOLERANSI :	MATERIAL MM MDF	TARİH / DATE 12.10.2018

8 mm Profiles

PROFİLSE - SİLAS ORMAN ÜRÜNLERİ

KAĞIT ÜZERİNDEN ÖLÇÜ ALMAYINIZ !!!
Don't measurate on paper.

ÜRÜN KODU : 08*20

(Product Code)

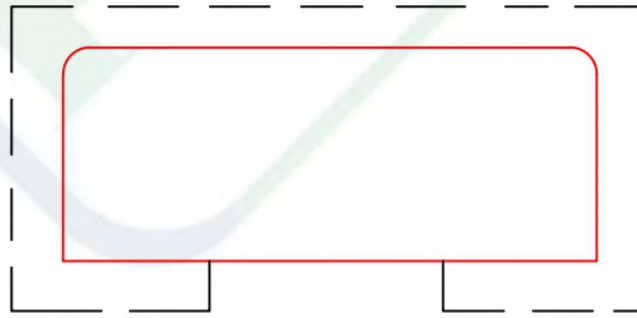
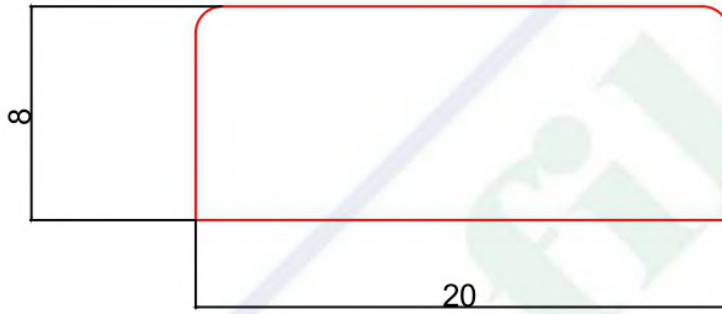

PVC BİTİŞ YERİ

(Pvc ending area)

BÖLÜM SORUMLUSU NEJDET ALTINTOPRAK	BU ÇİZİM PROFİLSE - SİLAS ORMAN ÜRÜNLERİ'NE AİTTİR. İZINSİZ ÇOĞALTILMAMAK VE KOPYA EDİLMEKEMEK ŞARTI İLE İZİN VERİLMİŞTİR.	PVC ENİ : MDF MIKTARI : PLAKADAN ÇIKAN :	KSM ÖLÇÜCÜ :	KUTU İÇİ : KUTU İÇİ ADET :
ARGE SORUMLUSU DOĞUKAN DEMİR	THIS DRAWING PROFILE - SILAS FOREST PRODUCTS WHAT TO DO. UNLOCKED AND COPY NOT ALLOWED WITH THE WRITTEN.	GENEL TOLERANS : PROFİL BOY TOLERANSI :	MATERIAL MM MDF	TARİH / DATE 12.11.2018

8 mm Profiles

PROFİLSE - SİLAS ORMAN ÜRÜNLERİ

KAĞIT ÜZERİNDEN ÖLÇÜ ALMAYINIZ !!!

ÜRÜN KODU : 08*12

(Product Code)

Don't measurate on paper.

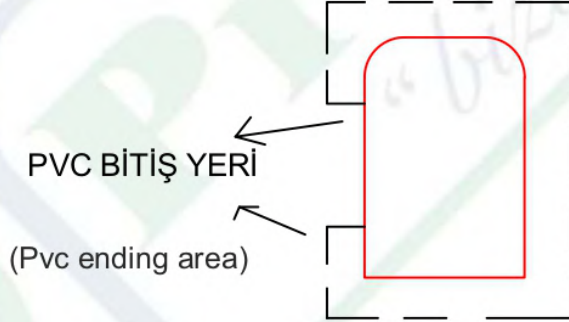
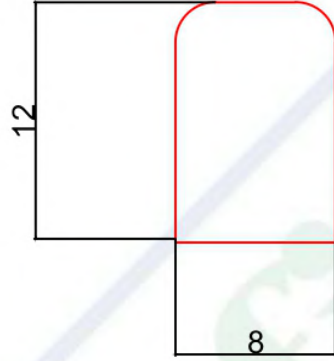

BÖLÜM SORUMLUSU NEJDET ALTINTOPRAK	BU ÇİZİM PROFİLSE - SİLAS ORMAN ÜRÜNLERİ'NE AİTTİR. İZINSİZ ÇOĞALTILMAMAK VE KOPYA EDİLMEMEK ŞARTI İLE İZİN VERİLMİŞTİR.	PVC ENİ : MDF MİKTARI : PLAKADAN ÇIKAN :	KSM ÖLÇÜCÜ :	KUTU İÇİ : KUTU İÇİ ADET :
ARGE SORUMLUSU DOĞUKAN DEMİR	THIS DRAWING PROFILE - SİLAS FOREST PRODUCTS WHAT TO DO. UNLOCKED AND COPY NOT ALLOWED WITH THE WRITTEN.	GENEL TOLERANS : PROFL BOY TOLERANSI :	MATERİYAL MM MDF	TARİH / DATE 03.10.2018

8 mm Profiles

PROFİLSE - SİLAS ORMAN ÜRÜNLERİ

KAĞIT ÜZERİNDEN ÖLÇÜ ALMAYINIZ !!!

ÜRÜN KODU : 08*60

Don't measurate on paper.

(Product Code)

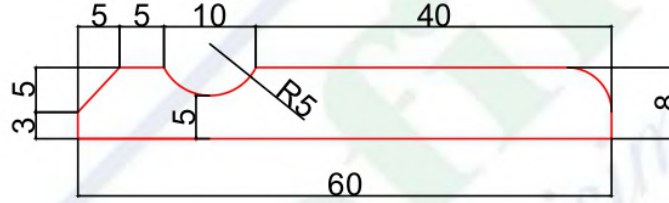

PVC BİTİŞ YERİ

(Pvc ending area)

BÖLÜM SORUMLUSU NEJDET ALTINTOPRAK	BU ÇİZİM PROFİLSE - SİLAS ORMAN ÜRÜNLERİ'NE AİTTİR. İZİNSİZ ÇOĞALTILMAMAK VE KOPYA EDİLMEKEMEK ŞARTI İLE İZİN VERİLMİŞTİR.	PVC ENİ : MDF MİKTARI : PLAKADAN ÇIKAN :	KSM ÖLÇÜCÜ :	KUTU İÇİ : KUTU İÇİ ADET :
ARGE SORUMLUSU DOĞUKAN DEMİR	THIS DRAWING PROFILE - SİLAS FOREST PRODUCTS WHAT TO DO. UNLOCKED AND COPY NOT ALLOWED WITH THE WRITTEN.	GENEL TOLERANS : PROFL BOY TOLERANSI :	MATERİAL MM MDF	TARİH / DATE 03.10.2018

8 mm Profiles

PROFİLSE - SİLAS ORMAN ÜRÜNLERİ

KAGIT ÜZERİNDEN ÖLÇÜ ALMAYINIZ !!!

ÜRÜN KODU : 08*16

Don't measurate on paper.

(Product Code)

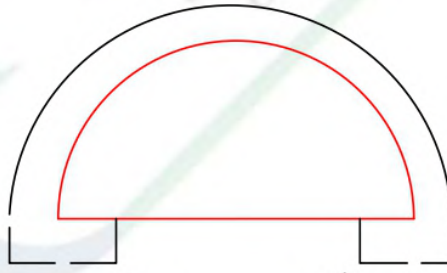
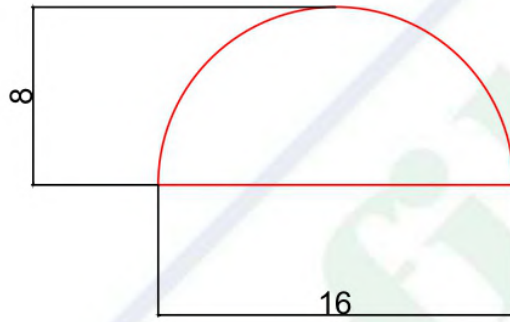

PVC BİTİŞ YERİ

(Pvc ending area)

BÖLÜM SORUMLUSU NEJDET ALTINTOPRAK	BU ÇİZİM PROFİLSE - SİLAS ORMAN ÜRÜNLERİ'NE AİTTİR. İZİNSİZ ÇOĞALTILMAMAK VE KOPYA EDİLMEK ŞARTI İLE İZİN VERİLMİŞTİR.	PVC ENİ : MDF MİKTARI : PLAKADAN ÇIKAN :	KSM ÖLÇÜCÜ :	KUTU İÇİ : KUTU İÇİ ADET :
ARGE SORUMLUSU DOĞUKAN DEMİR	THIS DRAWING PROFILE - SILAS FOREST PRODUCTS WHAT TO DO. UNLOCKED AND COPY NOT ALLOWED WITH THE WRITTEN.	GENEL TOLERANS : PROFİL BOY TOLERANSI :	MATERİYAL MM MDF	TARİH / DATE 10.10.2018

8 mm Profiles

PROFİLSE - SİLAS ORMAN ÜRÜNLERİ

KAĞIT ÜZERİNDEN ÖLÇÜ ALMAYINIZ !!!

Don't measurate on paper.

ÜRÜN KODU : 08*09

(Product Code)

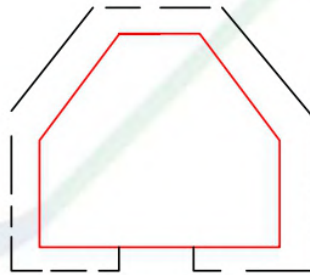
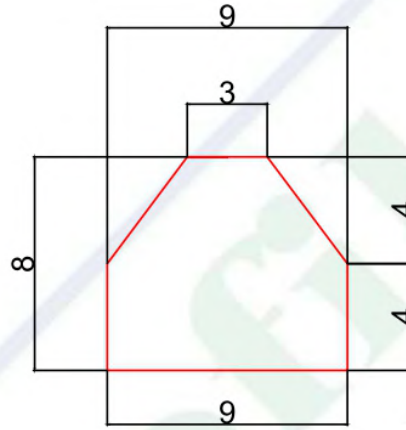

PVC BİTİŞ YERİ

(Pvc ending area)

BÖLÜM SORUMLUSU NEJDET ALTINTOPRAK	BU ÇİZİM PROFİLSE - SİLAS ORMAN ÜRÜNLERİ'NE AİTTİR. İZINSİZ ÇOĞALTILMAMAK VE KOPYA EDİLMEKEMEK ŞARTI İLE İZİN VERİLMİŞTİR.	PVC ENİ : MDF MİKTARI : PLAKADAN ÇIKAN :	KSM ÖLÇÜCÜ :	KUTU İÇİ : KUTU İÇİ ADET :
ARGE SORUMLUSU DOĞUKAN DEMİR	THIS DRAWING PROFILE - SİLAS FOREST PRODUCTS WHAT TO DO. UNLOCKED AND COPY NOT ALLOWED WITH THE WRITTEN.	GENEL TOLERANS : PROFİL BOY TOLERANSI :	MATERIAL MM MDF	TARİH / DATE 10.10.2018

8 mm Profiles

PROFİLSE - SİLAS ORMAN ÜRÜNLERİ

KAĞIT ÜZERİNDEN ÖLÇÜ ALMAYINIZ !!!

Don't measurate on paper.

ÜRÜN KODU : 08*27

(Product Code)

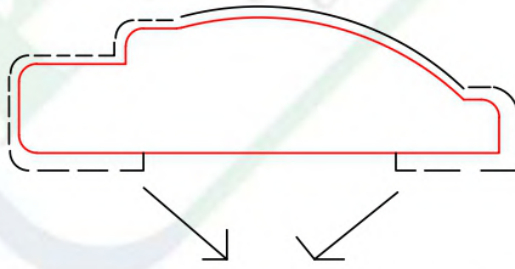
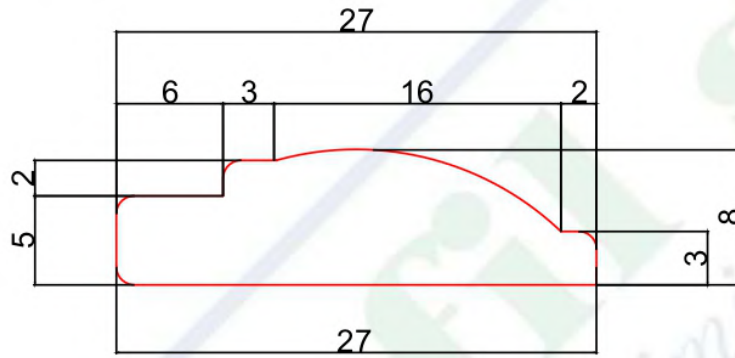

PVC BİTİŞ YERİ

(Pvc ending area)

BÖLÜM SORUMLUSU NEJDET ALTINTOPRAK	BU ÇİZİM PROFİLSE - SİLAS ORMAN ÜRÜNLERİ'NE AİTTİR. İZİNSİZ ÇOĞALTILMAMAK VE KOPYA EDİLMEMEK ŞARTI İLE İZİN VERİLMİŞTİR.	PVC ENİ : MDF MİKTARI : PLAKADAN ÇIKAN :	KSM ÖLÇÜCÜ :	KUTU İÇİ : KUTU İÇİ ADET :
ARGE SORUMLUSU DOĞUKAN DEMİR	THIS DRAWING PROFILE - SİLAS FOREST PRODUCTS WHAT TO DO. UNLOCKED AND COPY NOT ALLOWED WITH THE WRITTEN.	GENEL TOLERANS : PROFİL BOY TOLERANSI :	MATERİYAL MM MDF	TARİH / DATE 12.11.2018

8 mm Profiles

PROFİLSE - SİLAS ORMAN ÜRÜNLERİ

KAĞIT ÜZERİNDEN ÖLÇÜ ALMAYINIZ !!!

Don't measurate on paper.

ÜRÜN KODU : 08*30
(Product Code)

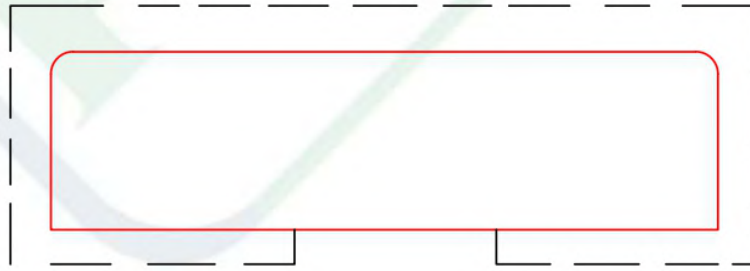
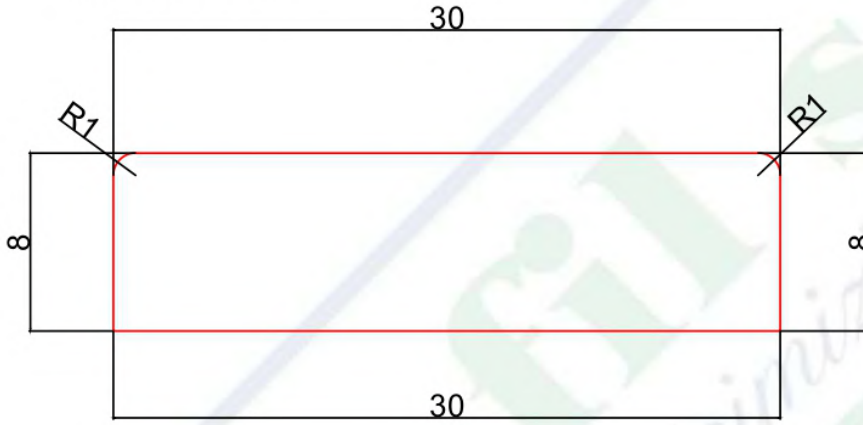

PVC BİTİŞ YERİ
(Pvc ending area)

BÖLÜM SORUMLUSU NEJDET ALTINTOPRAK	BU ÇİZİM PROFİLSE - SİLAS ORMAN ÜRÜNLERİ'NE AİTTİR. İZİNSİZ ÇOĞALTILMAMAK VE KOPYA EDİLMEKEMEK ŞARTI İLE İZİN VERİLMİŞTİR.	PVC ENİ : MDF MİKTARI : PLAKADAN ÇIKAN :	KSM ÖLÇÜCÜ :	KUTU İÇİ : KUTU İÇİ ADET :
ARGE SORUMLUSU DOĞUKAN DEMİR	THIS DRAWING PROFILE - SİLAS FOREST PRODUCTS WHAT TO DO. UNLOCKED AND COPY NOT ALLOWED WITH THE WRITTEN.	GENEL TOLERANS : PROFİL BOY TOLERANSI :	MATERİYAL MM MDF	TARİH / DATE 10.10.2018

8 mm Profiles

PROFİLSE - SİLAS ORMAN ÜRÜNLERİ

KAĞIT ÜZERİNDEN ÖLÇÜ ALMAYINIZ !!!

Don't measurate on paper.

ÜRÜN KODU : 08*15

(Product Code)

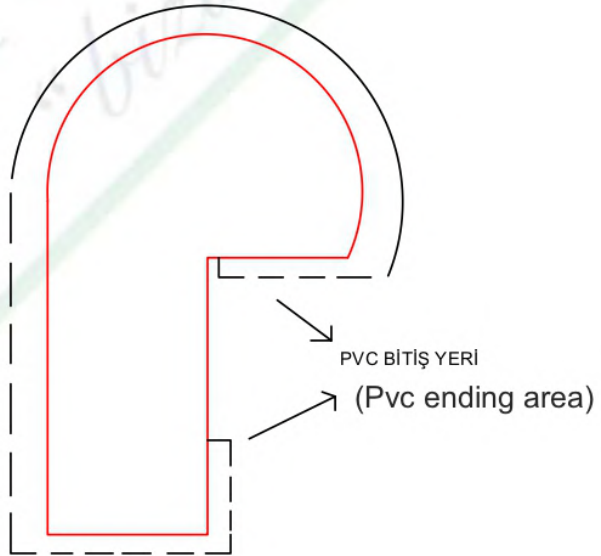
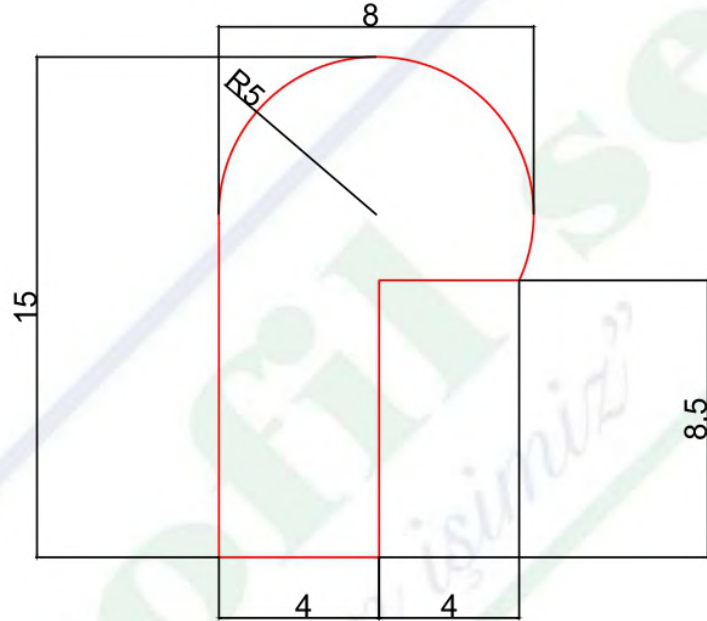

BÖLÜM SORUMLUSU NEJDET ALTINTOPRAK	BU ÇİZİM PROFİLSE - SİLAS ORMAN ÜRÜNLERİ'NE AİTTİR. İZINSİZ ÇOĞALTILMAMAK VE KOPYA EDİLMEK ŞARTI İLE İZİN VERİLMİŞTİR.	PVC ENİ : MDF MİKTARI : PLAKADAN ÇIKAN :	KSM ÖLÇÜCÜ :	KUTU İÇİ : KUTU İÇİ ADET :
ARGE SORUMLUSU DOĞUKAN DEMİR	THIS DRAWING PROFILE - SİLAS FOREST PRODUCTS WHAT TO DO. UNLOCKED AND COPY NOT ALLOWED WITH THE WRITTEN.	GENEL TOLERANS : PROFİL BOY TOLERANSI :	MATERİYAL MM MDF	TARİH / DATE 04.10.2018

8 mm Profiles

PROFİLSE - SİLAS ORMAN ÜRÜNLERİ

KAĞIT ÜZERİNDEN ÖLÇÜ ALMAYINIZ !!!
Don't measure on paper.

ÜRÜN KODU : 08*18
(Product Code)

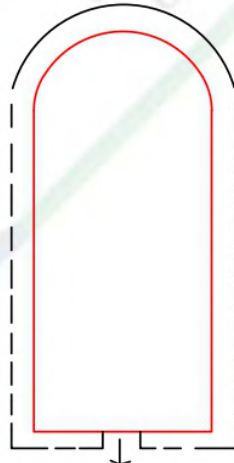

PVC BİTİŞ YERİ (Pvc ending area)

BÖLÜM SORUMLUSU NEJDET ALTINTOPRAK	BU ÇİZİM PROFİLSE - SİLAS ORMAN ÜRÜNLERİ'NE AİTTİR. İZİNSİZ ÇOĞALTILMAMAK VE KOPYA EDİLMEMEK ŞARTI İLE İZİN VERİLMİŞTİR.	PVC ENİ : MDF MİKTARI : PLAKADAN ÇIKAN :	KSM ÖLÇÜCÜ :	KUTU İÇİ : KUTU İÇİ ADET :
ARGE SORUMLUSU DOĞUKAN DEMİR	THIS DRAWING PROFILE - SİLAS FOREST PRODUCTS WHAT TO DO. UNLOCKED AND COPY NOT ALLOWED WITH THE WRITTEN.	GENEL TOLERANS : PROFİL BOY TOLERANSI :	MATERİYAL MM MDF	TARİH / DATE 04.10.2018

8 mm Profiles

PROFİLSE - SİLAS ORMAN ÜRÜNLERİ

ÜRÜN KODU : 08*25
(Product Code)

KAĞIT ÜZERİNDEN ÖLÇÜ ALMAYINIZ !!!
Don't measure on paper.

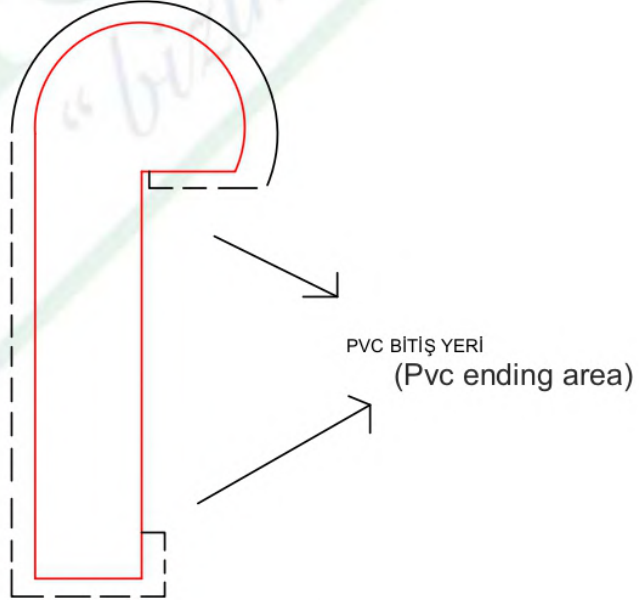
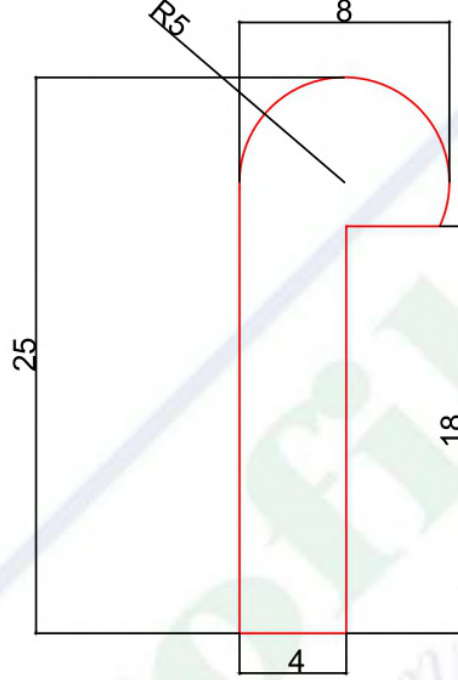

BÖLÜM SORUMLUSU NEJDET ALTINTOPRAK	BU ÇİZİM PROFİLSE - SİLAS ORMAN ÜRÜNLERİ'NE AİTTİR. İZİNSİZ ÇOĞALTILMAMAK VE KOPYA EDİLMEMEK ŞARTI İLE İZİN VERİLMİŞTİR.	PVC ENİ : MDF MİKTARI : PLAKADAN ÇIKAN :	KSM ÖLÇÜCÜ :	KUTU İÇİ : KUTU İÇİ ADET :
ARGE SORUMLUSU DOĞUKAN DEMİR	THIS DRAWING PROFILE - SİLAS FOREST PRODUCTS WHAT TO DO. UNLOCKED AND COPY NOT ALLOWED WITH THE WRITTEN.	GENEL TOLERANS : PROFİL BOY TOLERANSI :	MATERİYAL MM MDF	TARİH / DATE 04.10.2018

8 mm Profiles

PROFİLSE - SİLAS ORMAN ÜRÜNLERİ

KAĞIT ÜZERİNDEN ÖLÇÜ ALMAYINIZ !!!
Don't measurate on paper.

ÜRÜN KODU : 08*12

(Product Code)

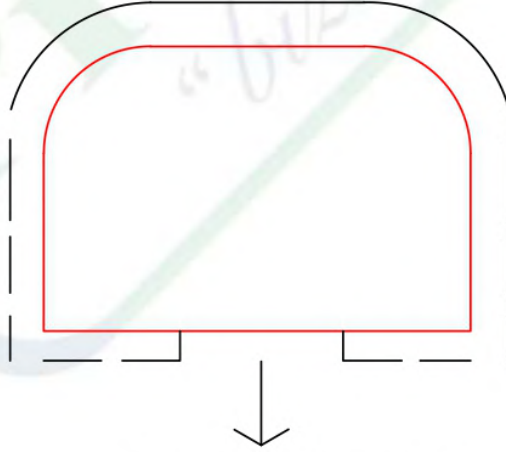
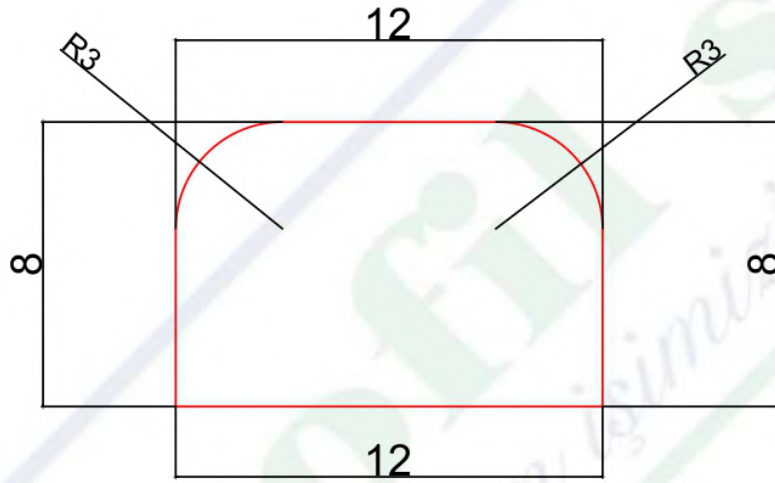

(Pvc ending area)

BÖLÜM SORUMLUSU NEJDET ALTINTOPRAK	BU ÇİZİM PROFİLSE - SİLAS ORMAN ÜRÜNLERİ'NE AİTTİR. İZINSİZ ÇOĞALTILMAMAK VE KOPYA EDİLMEKEMEK ŞARTI İLE İZİN VERİLMİŞTİR.	PVC ENİ : MDF MIKTARI : PLAKADAN ÇIKAN :	KSM ÖLÇÜCÜ :	KUTU İÇİ : KUTU İÇİ ADET :
ARGE SORUMLUSU DOĞUKAN DEMİR	THIS DRAWING PROFILE - SİLAS FOREST PRODUCTS WHAT TO DO. UNLOCKED AND COPY NOT ALLOWED WITH THE WRITTEN.	GENEL TOLERANS : PROFİL BOY TOLERANSI :	MATERİYAL MM MDF	TARİH / DATE 25.01.2019

8 mm Profiles

PROFİLSE - SİLAS ORMAN ÜRÜNLERİ

KAĞIT ÜZERİNDEN ÖLÇÜ ALMAYINIZ !!!
Don't measure on paper.

ÜRÜN KODU : 08*16

(Product Code)

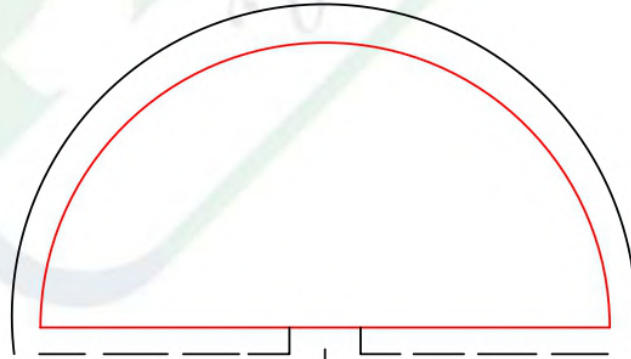
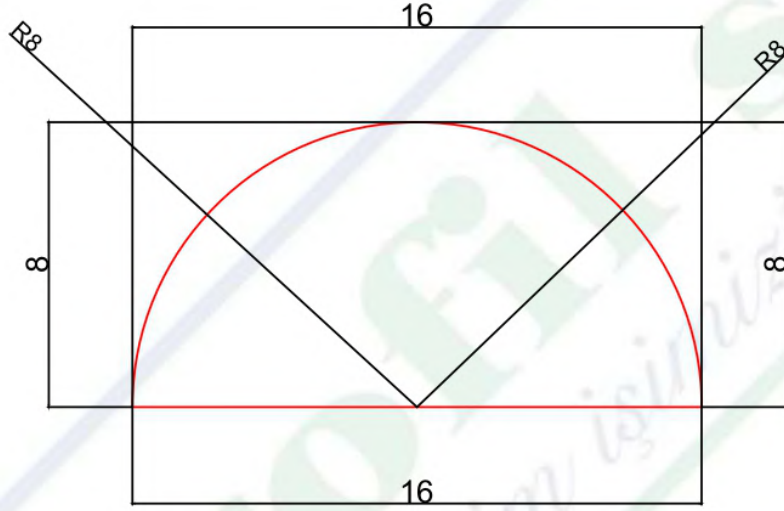

PVC BİTİŞ YERİ
(Pvc ending area)

BÖLÜM SORUMLUSU NEJDET ALTINTOPRAK	BU ÇİZİM PROFİLSE - SİLAS ORMAN ÜRÜNLERİ'NE AİTTİR. İZINSİZ ÇOĞALTILMAMAK VE KOPYA EDİLMEMEK ŞARTI İLE İZİN VERİLMİŞTİR.	PVC ENİ : MDF MİKTARI : PLAKADAN ÇIKAN :	KSM ÖLÇÜCÜ :	KUTU İÇİ : KUTU İÇİ ADET :
ARGE SORUMLUSU DOĞUKAN DEMİR	THIS DRAWING PROFILE - SİLAS FOREST PRODUCTS WHAT TO DO. UNLOCKED AND COPY NOT ALLOWED WITH THE WRITTEN.	GENEL TOLERANS : PROFİL BOY TOLERANSI :	MATERİYAL MM MDF	TARİH / DATE 03.04.2019

8 mm Profiles

PROFİLSE - SİLAS ORMAN ÜRÜNLERİ

KAĞIT ÜZERİNDEN ÖLÇÜ ALMAYINIZ !!!
Don't measurate on paper.

ÜRÜN KODU : 08*15-07
(Product Code)

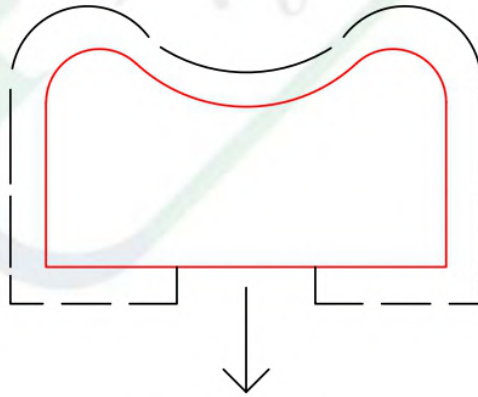
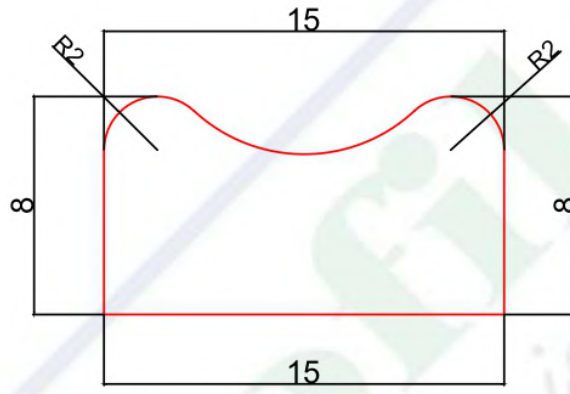

PVC BİTİŞ YERİ
(Pvc ending area)

BÖLÜM SORUMLUSU NEJDET ALTINTOPRAK	BU ÇİZİM PROFİLSE - SİLAS ORMAN ÜRÜNLERİ'NE AİTTİR. İZINSİZ ÇOĞALTILMAMAK VE KOPYA EDİLMEMEK ŞARTI İLE İZİN VERİLMİŞTİR.	MDF MİKTARI : TABAKADAN ÇIKAN :	PVC ÖLÇÜSÜ :	KUTU İÇİ : KUTU İÇİ ADET :
ARGE SORUMLUSU DOĞUKAN DEMİR	THIS DRAWING PROFILE - SİLAS FOREST PRODUCTS WHAT TO DO. UNLOCKED AND COPY NOT ALLOWED WITH THE WRITTEN.	STANDART PROFİL BOY : PROFİL BOY :	MDF TÜRÜ MM MDF	TARİH / DATE 20.05.2019

8 mm Profiles

PROFİLSE - SİLAS ORMAN ÜRÜNLERİ

KAĞIT ÜZERİNDEN ÖLÇÜ ALMAYINIZ !!!
Don't measure on paper.

ÜRÜN KODU : 08*15
(Product Code)

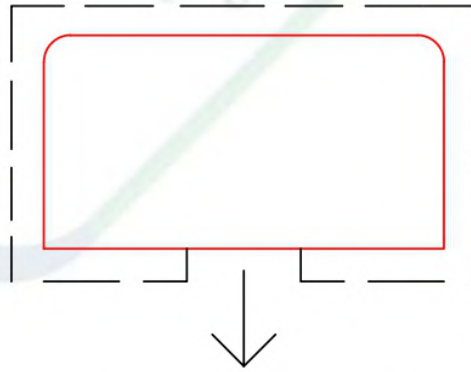
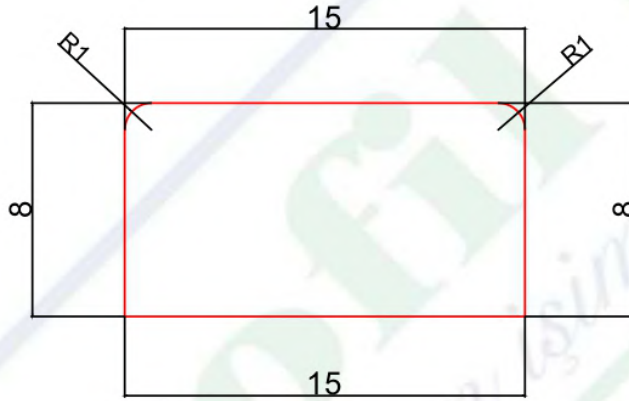

PVC BİTİŞ YERİ
(Pvc ending area)

BÖLÜM SORUMLUSU NEJDET ALTINTOPRAK	BU ÇİZİM PROFİLSE - SİLAS ORMAN ÜRÜNLERİ'NE AİTTİR. İZINSİZ ÇOĞALTILMAMAK VE KOPYA EDİLMEMEK ŞARTI İLE İZİN VERİLMİŞTİR.	PVC ENİ : MDF MİKTARI : PLAKADAN ÇIKAN :	KSM ÖLÇÜCÜ :	KUTU İÇİ : KUTU İÇİ ADET :
ARGE SORUMLUSU DOĞUKAN DEMİR	THIS DRAWING PROFILE - SİLAS FOREST PRODUCTS WHAT TO DO. UNLOCKED AND COPY NOT ALLOWED WITH THE WRITTEN.	GENEL TOLERANS : PROFL BOY TOLERANSI :	MATERİYAL MM MDF	TARİH / DATE 11.04.2019

8 mm Profiles

PROFİLSE - SİLAS ORMAN ÜRÜNLERİ

KAĞIT ÜZERİNDEN ÖLÇÜ ALMAYINIZ !!!

Don't measurate on paper.

ÜRÜN KODU : 08*20

(Product Code)

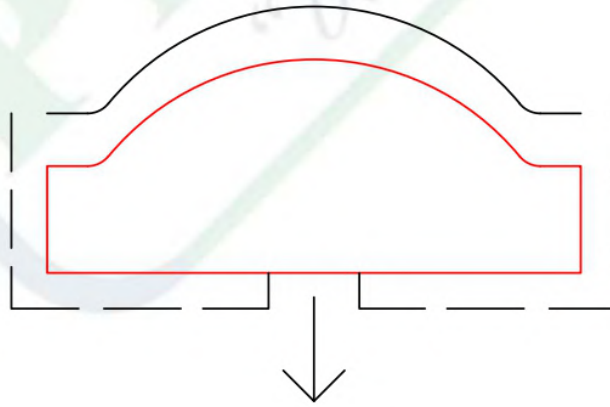
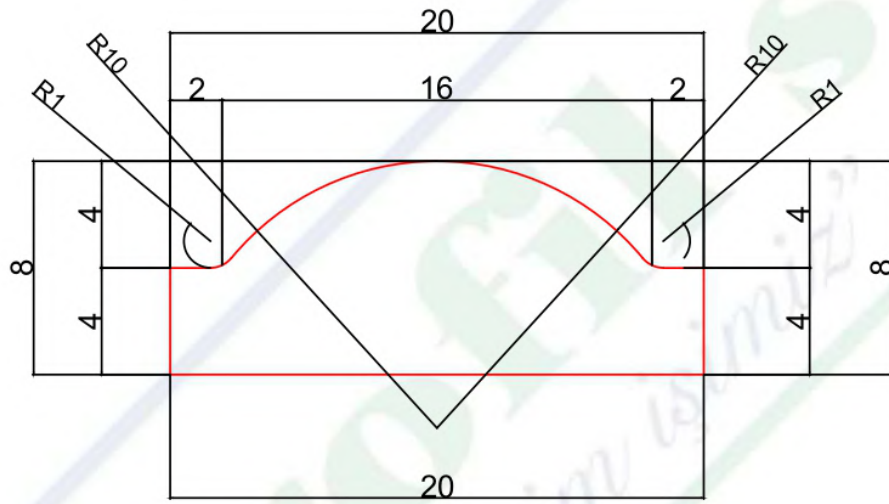

PVC BİTİŞ YERİ
(Pvc ending area)

BÖLÜM SORUMLUSU NEJDET ALTINTOPRAK	BU ÇİZİM PROFİLSE - SİLAS ORMAN ÜRÜNLERİ'NE AİTTİR. İZİNSİZ ÇOĞALTILMAMAK VE KOPYA EDİLMEKEMEK ŞARTI İLE İZİN VERİLMİŞTİR.	PVC ENİ : MDF MİKTARI : PLAKADAN ÇIKAN :	KSM ÖLÇÜCÜ :	KUTU İÇİ : KUTU İÇİ ADET :
ARGE SORUMLUSU DOĞUKAN DEMİR	THIS DRAWING PROFILE - SİLAS FOREST PRODUCTS WHAT TO DO. UNLOCKED AND COPY NOT ALLOWED WITH THE WRITTEN.	GENEL TOLERANS : PROFİL BOY TOLERANSI :	MATERIAL MM MDF	TARİH / DATE 11.04.2019

8 mm Profiles

PROFİLSE - SİLAS ORMAN ÜRÜNLERİ

KAĞIT ÜZERİNDEN ÖLÇÜ ALMAYINIZ !!!
Don't measurate on paper.

ÜRÜN KODU : 08*40
(Product Code)

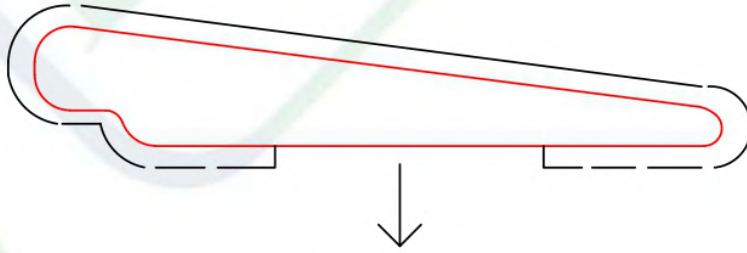
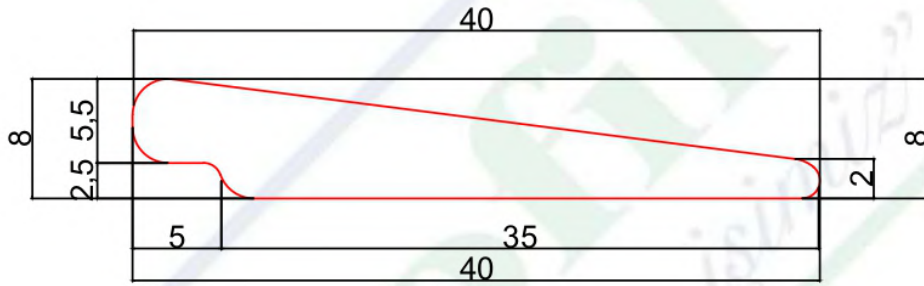

PVC BİTİŞ YERİ
(Pvc ending area)

BÖLÜM SORUMLUSU NEJDET ALTINTOPRAK	BU ÇİZİM PROFİLSE - SİLAS ORMAN ÜRÜNLERİ 'NE AİTTİR. İZINSİZ ÇOĞALTILMAMAK VE KOPYA EDİLMEMEK ŞARTI İLE İZİN VERİLMİŞTİR.	PVC ENİ : MDF MİKTARI : PLAKADAN ÇIKAN :	KSM ÖLÇÜCÜ :	KUTU İÇİ : KUTU İÇİ ADET :
ARGE SORUMLUSU DOĞUKAN DEMİR	THIS DRAWING PROFILE - SİLAS FOREST PRODUCTS WHAT TO DO. UNLOCKED AND COPY NOT ALLOWED WITH THE WRITTEN.	GENEL TOLERANS : PROFİL BOY TOLERANSI :	MATERİYAL MM MDF	TARİH / DATE 11.04.2019

8 mm Profiles

PROFİLSE - SİLAS ORMAN ÜRÜNLERİ

KAĞIT ÜZERİNDEN ÖLÇÜ ALMAYINIZ !!!
Don't measurate on paper.

ÜRÜN KODU : 08*14
(Product Code)

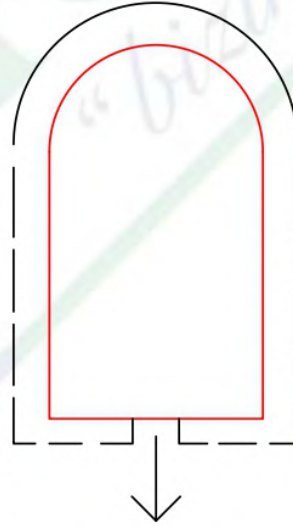
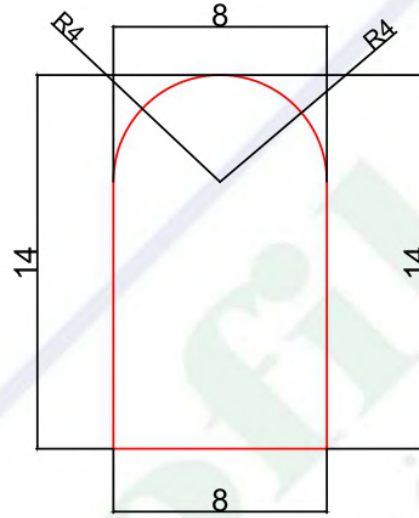

PVC BİTİŞ YERİ
(Pvc ending area)

BÖLÜM SORUMLUSU NEJDET ALTINTOPRAK	BU ÇİZİM PROFİLSE - SİLAS ORMAN ÜRÜNLERİ'NE AİTTİR. İZINSİZ ÇOĞALTILMAMAK VE KOPYA EDİLMEMEK ŞARTI İLE İZİN VERİLMİŞTİR.	PVC ENİ : MDF MİKTARI : PLAKADAN ÇIKAN :	KSM ÖLÇÜCÜ :	KUTU İÇİ : KUTU İÇİ ADET :
ARGE SORUMLUSU DOĞUKAN DEMİR	THIS DRAWING PROFILE - SİLAS FOREST PRODUCTS WHAT TO DO. UNLOCKED AND COPY NOT ALLOWED WITH THE WRITTEN.	GENEL TOLERANS : PROFİL BOY TOLERANSI :	MATERİYAL MM MDF	TARİH / DATE 17.04.2019

8 mm Profiles

PROFİLSE - SİLAS ORMAN ÜRÜNLERİ

KAĞIT ÜZERİNDEN ÖLÇÜ ALMAYINIZ !!!
Don't measurate on paper.

ÜRÜN KODU : 08*08
(Product Code)

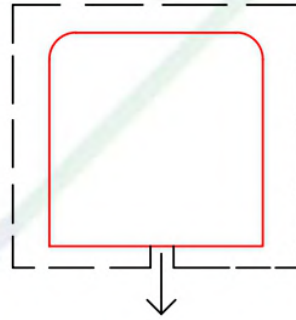
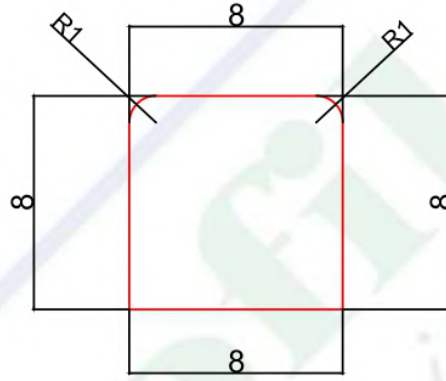

PVC BİTİŞ YERİ

(Pvc ending area)

BÖLÜM SORUMLUSU NEJDET ALTINTOPRAK	BU ÇİZİM PROFİLSE - SİLAS ORMAN ÜRÜNLERİ'NE AİTTİR. İZİNSİZ ÇOĞALTILMAMAK VE KOPYA EDİLMEKEMEK ŞARTI İLE İZİN VERİLMİŞTİR.	PVC ENİ : MDF MİKTARI : PLAKADAN ÇIKAN :	KSM ÖLÇÜCÜ :	KUTU İÇİ : KUTU İÇİ ADET :
ARGE SORUMLUSU DOĞUKAN DEMİR	THIS DRAWING PROFILE - SİLAS FOREST PRODUCTS WHAT TO DO. UNLOCKED AND COPY NOT ALLOWED WITH THE WRITTEN.	GENEL TOLERANS : PROFL BOY TOLERANSI :	MATERİYAL MM MDF	TARİH / DATE 17.04.2019

8 mm Profiles

PROFİLSE - SİLAS ORMAN ÜRÜNLERİ

KAĞIT ÜZERİNDEN ÖLÇÜ ALMAYINIZ !!!
Don't measurate on paper.

ÜRÜN KODU : 08*08
(Product Code)

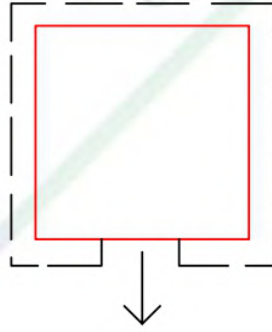
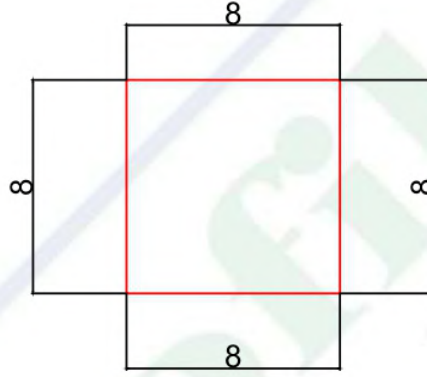

PVC BİTİŞ YERİ

(Pvc ending area)

BÖLÜM SORUMLUSU NEJDET ALTINTOPRAK	BU ÇİZİM PROFİLSE - SİLAS ORMAN ÜRÜNLERİ'NE AİTTİR. İZINSİZ ÇOĞALTILMAMAK VE KOPYA EDİLMEKEMK ŞARTI İLE İZİN VERİLMİŞTİR.	PVC ENİ : MDF MİKTARI : PLAKADAN ÇIKAN :	KSM ÖLÇÜCÜ :	KUTU İÇİ : KUTU İÇİ ADET :
ARGE SORUMLUSU DOĞUKAN DEMİR	THIS DRAWING PROFILE - SİLAS FOREST PRODUCTS WHAT TO DO. UNLOCKED AND COPY NOT ALLOWED WITH THE WRITTEN.	GENEL TOLERANS : PROFİL BOY TOLERANSI :	MATERİYAL MM MDF	TARİH / DATE 17.04.2019

10 mm Profiles

PROFİLSE - SİLAS ORMAN ÜRÜNLERİ

KAĞIT ÜZERİNDEN ÖLÇÜ ALMAYINIZ !!!
Don't measurate on paper.

ÜRÜN KODU : 10*26

(Product Code)

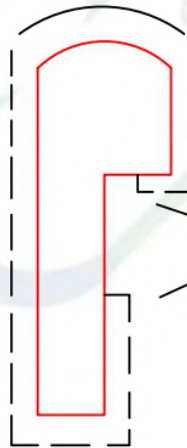
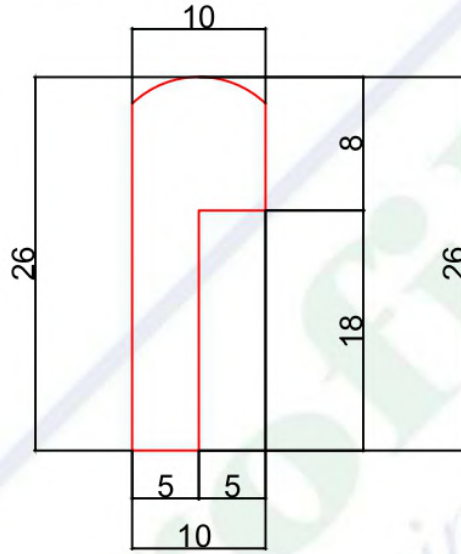

PVC BİTİŞ YERİ
(Pvc ending area)

BÖLÜM SORUMLUSU NEJDET ALTINTOPRAK	BU ÇİZİM PROFİLSE - SİLAS ORMAN ÜRÜNLERİ'NE AİTTİR. İZINSİZ ÇOĞALTILMAMAK VE KOPYA EDİLMEMEK ŞARTI İLE İZİN VERİLMİŞTİR.	PVC ENİ : MDF MİKTARI : PLAKADAN ÇIKAN :	KSM ÖLÇÜCÜ :	KUTU İÇİ : KUTU İÇİ ADET :
ARGE SORUMLUSU DOĞUKAN DEMİR	THIS DRAWING PROFILE - SİLAS FOREST PRODUCTS WHAT TO DO. UNLOCKED AND COPY NOT ALLOWED WITH THE WRITTEN.	GENEL TOLERANS : PROFİL BOY TOLERANSI :	MATERİYAL MM MDF	TARİH / DATE 19.11.2018

10 mm Profiles

PROFİLSE - SİLAS ORMAN ÜRÜNLERİ

KAĞIT ÜZERİNDEN ÖLÇÜ ALMAYINIZ !!!

ÜRÜN KODU : 10*18

Don't measurate on paper.

(Product Code)

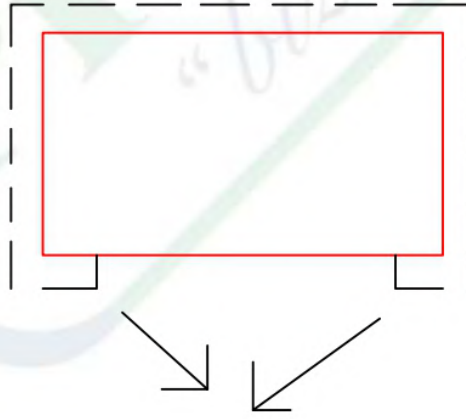
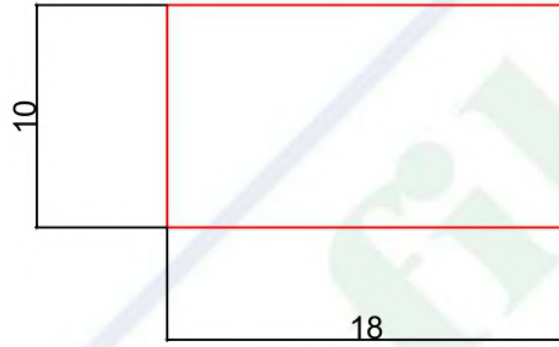

PVC BİTİŞ YERİ
(Pvc ending area)

BÖLÜM SORUMLUSU NEJDET ALTINTOPRAK	BU ÇİZİM PROFİLSE - SİLAS ORMAN ÜRÜNLERİ'NE AİTTİR. İZINSİZ ÇOĞALTILMAMAK VE KOPYA EDİLMEMEK ŞARTI İLE İZİN VERİLMİŞTİR.	PVC ENİ : MDF MİKTARI : PLAKADAN ÇIKAN :	KSM ÖLÇÜCÜ :	KUTU İÇİ : KUTU İÇİ ADET :
ARGE SORUMLUSU DOĞUKAN DEMİR	THIS DRAWING PROFILE - SILAS FOREST PRODUCTS WHAT TO DO. UNLOCKED AND COPY NOT ALLOWED WITH THE WRITTEN.	GENEL TOLERANS : PROFİL BOY TOLERANSI :	MATERIAL MM MDF	TARİH / DATE 10.09.2018

10 mm Profiles

PROFİLSE - SİLAS ORMAN ÜRÜNLERİ

KAĞIT ÜZERİNDEN ÖLÇÜ ALMAYINIZ !!!

Don't measurate on paper.

ÜRÜN KODU : 10*18

(Product Code)

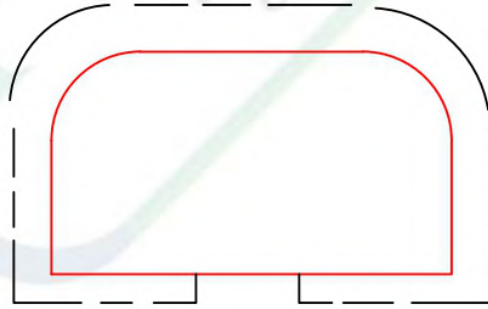
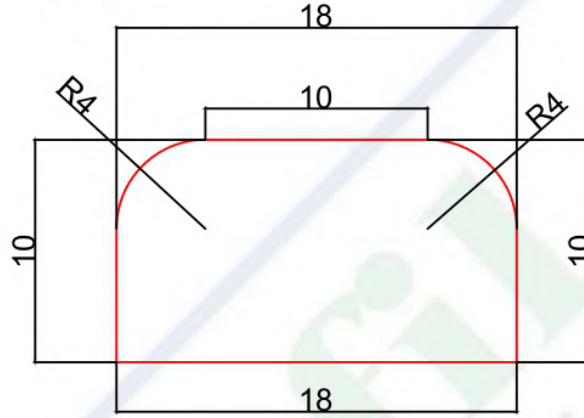

PVC BİTİŞ YERİ
(Pvc ending area)

BÖLÜM SORUMLUSU NEJDET ALTINTOPRAK	BU ÇİZİM PROFİLSE - SİLAS ORMAN ÜRÜNLERİ'NE AITTİR. İZINSİZ ÇOĞALTILMAMAK VE KOPYA EDİLMEMEK ŞARTI İLE İZİN VERİLMİŞTİR.	PVC ENİ : MDF MİKTARI : PLAKADAN ÇIKAN :	KSM ÖLÇÜCÜ :	KUTU İÇİ : KUTU İÇİ ADET :
ARGE SORUMLUSU DOĞUKAN DEMİR	THIS DRAWING PROFILE - SİLAS FOREST PRODUCTS WHAT TO DO. UNLOCKED AND COPY NOT ALLOWED WITH THE WRITTEN.	GENEL TOLERANS : PROFİL BOY TOLERANSI :	MATERİYAL MM MDF	TARİH / DATE 10.10.2018

10 mm Profiles

PROFİLSE - SİLAS ORMAN ÜRÜNLERİ

KAĞIT ÜZERİNDEN ÖLÇÜ ALMAYINIZ !!!

Don't measurate on paper.

ÜRÜN KODU : 10*16

(Product Code)

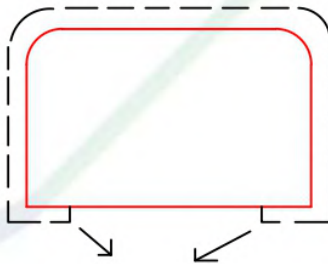
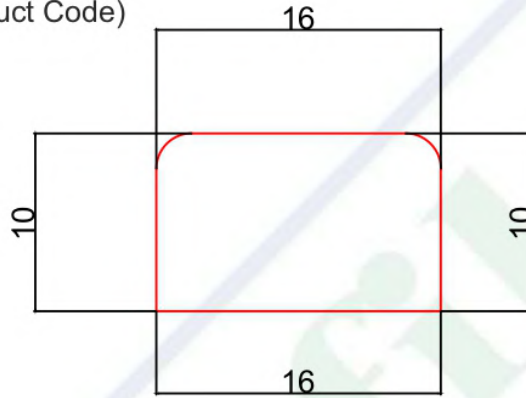

PVC BİTİŞ YERİ

(Pvc ending area)

BÖLÜM SORUMLUSU NEJDET ALTINTOPRAK	BU ÇİZİM PROFİLSE - SİLAS ORMAN ÜRÜNLERİ'NE AITTİR. İZİNSİZ ÇOĞALTILMAMAK VE KOPYA EDİLMEMEK ŞARTI İLE İZİN VERİLMİŞTİR.	PVC ENİ : MDF MİKTARI : PLAKADAN ÇIKAN :	KSM ÖLÇÜCÜ :	KUTU İÇİ : KUTU İÇİ ADET :
ARGE SORUMLUSU DOĞUKAN DEMİR	THIS DRAWING PROFILE - SİLAS FOREST PRODUCTS WHAT TO DO. UNLOCKED AND COPY NOT ALLOWED WITH THE WRITTEN.	GENEL TOLERANS : PROFL BOY TOLERANSI :	MATERİYAL MM MDF	TARİH / DATE 12.11.2018

10 mm Profiles

PROFİLSE - SİLAS ORMAN ÜRÜNLERİ

KAĞIT ÜZERİNDEN ÖLÇÜ ALMAYINIZ !!!
Don't measure on paper.

ÜRÜN KODU : 10*38

(Product Code)

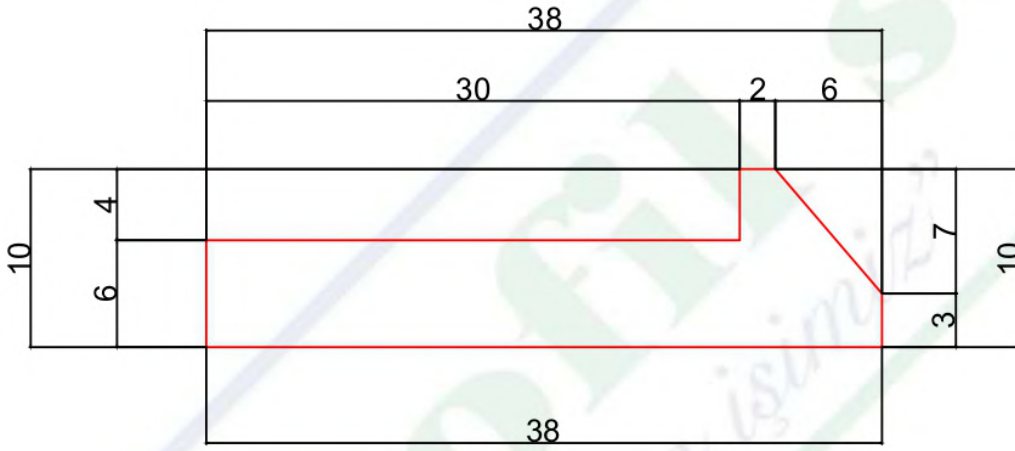

BÖLÜM SORUMLUSU NEJDET ALTINTOPRAK	BU ÇİZİM PROFİLSE - SİLAS ORMAN ÜRÜNLERİ'NE AİTTİR. İZINSİZ ÇOĞALTILMAMAK VE KOPYA EDİLMEK ŞARTI İLE İZİN VERİLMİŞTİR.	PVC ENİ : MDF MİKTARI : PLAKADAN ÇIKAN :	KSM ÖLÇÜCÜ :	KUTU İÇİ : KUTU İÇİ ADET :
ARGE SORUMLUSU DOĞUKAN DEMİR	THIS DRAWING PROFILE - SİLAS FOREST PRODUCTS WHAT TO DO. UNLOCKED AND COPY NOT ALLOWED WITH THE WRITTEN.	GENEL TOLERANS : PROFİL BOY TOLERANSI :	MATERIAL MM MDF	TARİH / DATE 17.12.2018

10 mm Profiles

PROFİLSE - SİLAS ORMAN ÜRÜNLERİ

KAĞIT ÜZERİNDEN ÖLÇÜ ALMAYINIZ !!!

ÜRÜN KODU : 10*15

Don't measurate on paper.

(Product Code)

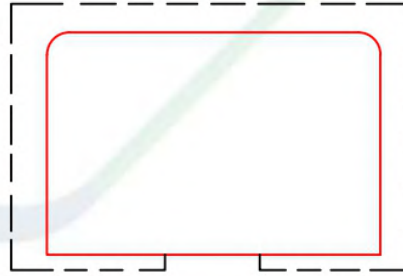
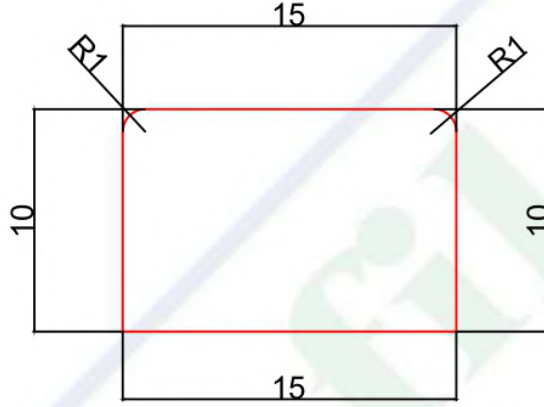

PVC BİTİŞ YERİ
(Pvc ending area)

BÖLÜM SORUMLUSU NEJDET ALTINTOPRAK	BU ÇİZİM PROFİLSE - SİLAS ORMAN ÜRÜNLERİ'NE AİTTİR. İZINSİZ ÇOĞALTILMAMAK VE KOPYA EDİLMEK ŞARTI İLE İZİN VERİLMİŞTİR.	PVC ENİ : MDF MİKTARI : PLAKADAN ÇIKAN :	KSM ÖLÇÜCÜ :	KUTU İÇİ : KUTU İÇİ ADET :
ARGE SORUMLUSU DOĞUKAN DEMİR	THIS DRAWING PROFILE - SİLAS FOREST PRODUCTS WHAT TO DO. UNLOCKED AND COPY NOT ALLOWED WITH THE WRITTEN.	GENEL TOLERANS : PROFL BOY TOLERANSI :	MATERİAL MM MDF	TARİH / DATE 10.10.2018

10 mm Profiles

PROFİLSE - SİLAS ORMAN ÜRÜNLERİ

KAĞIT ÜZERİNDEN ÖLÇÜ ALMAYINIZ !!!

Don't measurate on paper.

ÜRÜN KODU : 10*55

(Product Code)

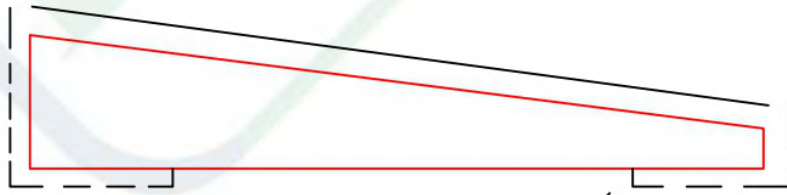
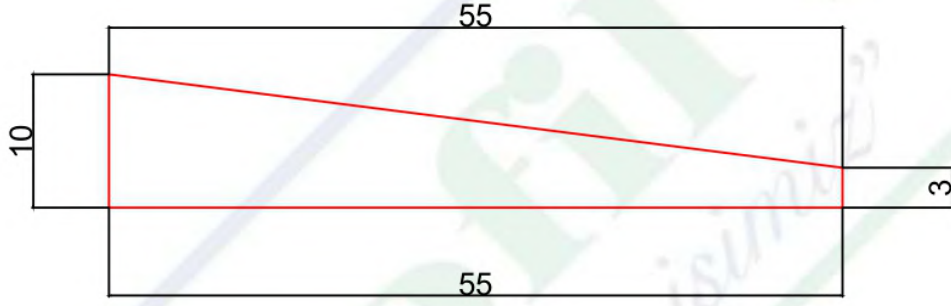

PVC BİTİŞ YERİ

(Pvc ending area)

BÖLÜM SORUMLUSU NEJDET ALTINTOPRAK	BU ÇİZİM PROFİLSE - SİLAS ORMAN ÜRÜNLERİ'NE AİTTİR. İZINSİZ ÇOĞALTILMAMAK VE KOPYA EDİLMEMEK ŞARTI İLE İZİN VERİLMİŞTİR.	PVC ENİ : MDF MİKTARI : PLAKADAN ÇIKAN :	KSM ÖLÇÜCÜ :	KUTU İÇİ : KUTU İÇİ ADET :
ARGE SORUMLUSU DOĞUKAN DEMİR	THIS DRAWING PROFILE - SİLAS FOREST PRODUCTS WHAT TO DO. UNLOCKED AND COPY NOT ALLOWED WITH THE WRITTEN.	GENEL TOLERANS : PROFİL BOY TOLERANSI :	MATERİYAL MM MDF	TARİH / DATE 10.10.2018

10 mm Profiles

PROFİLSE - SİLAS ORMAN ÜRÜNLERİ

KAĞIT ÜZERİNDEN ÖLÇÜ ALMAYINIZ !!!
Don't measure on paper.

ÜRÜN KODU : 10*18
(Product Code)

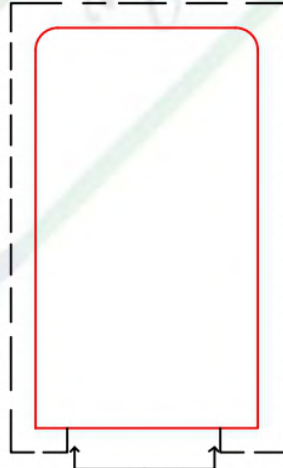
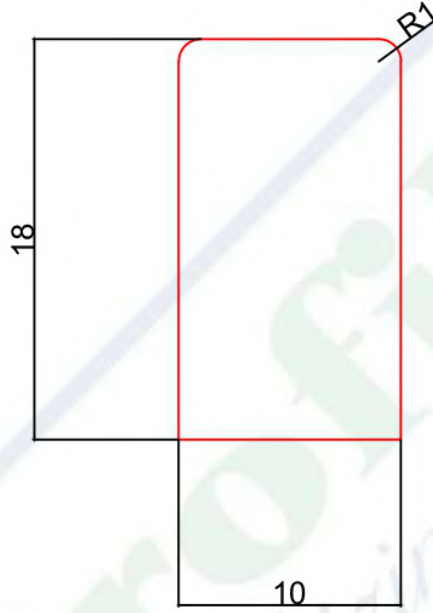

PVC BITİŞ YERİ (Pvc ending area)

BÖLÜM SORUMLUSU NEJDET ALTINTOPRAK	BU ÇİZİM PROFİLSE - SİLAS ORMAN ÜRÜNLERİ'NE AİTTİR. İZİNSİZ ÇOĞALTILMAMAK VE KOPYA EDİLMEMEK ŞARTI İLE İZİN VERİLMİŞTİR.	PVC ENİ : MDF MİKTARI : PLAKADAN ÇIKAN :	KSM ÖLÇÜCÜ :	KUTU İÇİ : KUTU İÇİ ADET :
ARGE SORUMLUSU DOĞUKAN DEMİR	THIS DRAWING PROFILE - SİLAS FOREST PRODUCTS WHAT TO DO. UNLOCKED AND COPY NOT ALLOWED WITH THE WRITTEN.	GENEL TOLERANS : PROFİL BOY TOLERANSI :	MATERİYAL MM MDF	TARİH / DATE 04.10.2018

10 mm Profiles

PROFİLSE - SİLAS ORMAN ÜRÜNLERİ

KAĞIT ÜZERİNDEN ÖLÇÜ ALMAYINIZ !!!
Don't measure on paper.

ÜRÜN KODU : 10*40
(Product Code)

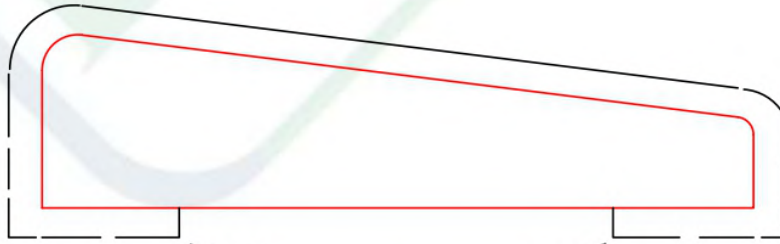
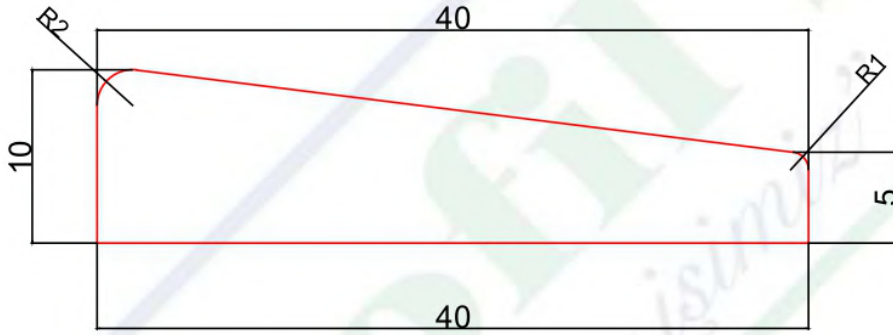

PVC BİTİŞ YERİ
(Pvc ending area)

BÖLÜM SORUMLUSU NEJDET ALTINTOPRAK	BU ÇİZİM PROFİLSE - SİLAS ORMAN ÜRÜNLERİ'NE AİTTİR. İZINSİZ ÇOĞALTILMAMAK VE KOPYA EDİLMEMEK ŞARTI İLE İZİN VERİLMİŞTİR.	PVC ENİ : MDF MİKTARI : PLAKADAN ÇIKAN :	KSM ÖLÇÜCÜ :	KUTU İÇİ : KUTU İÇİ ADET :
ARGE SORUMLUSU DOĞUKAN DEMİR	THIS DRAWING PROFILE - SİLAS FOREST PRODUCTS WHAT TO DO. UNLOCKED AND COPY NOT ALLOWED WITH THE WRITTEN.	GENEL TOLERANS : PROFİL BOY TOLERANSI :	MATERİYAL MM MDF	TARİH / DATE 01.03.2019

10 mm Profiles

PROFİLSE - SİLAS ORMAN ÜRÜNLERİ

KAĞIT ÜZERİNDEN ÖLÇÜ ALMAYINIZ !!!
Don't measure on paper.

ÜRÜN KODU : 10*19
(Product Code)

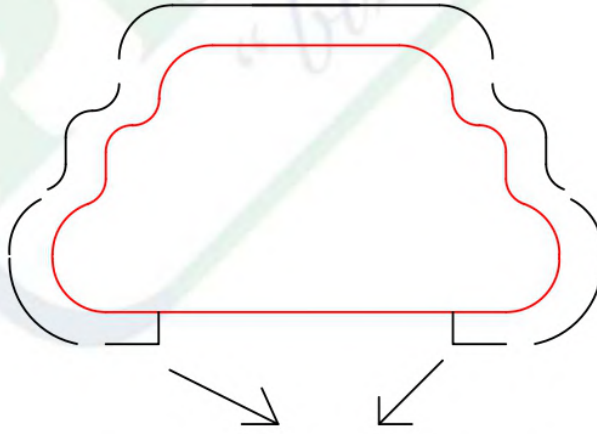
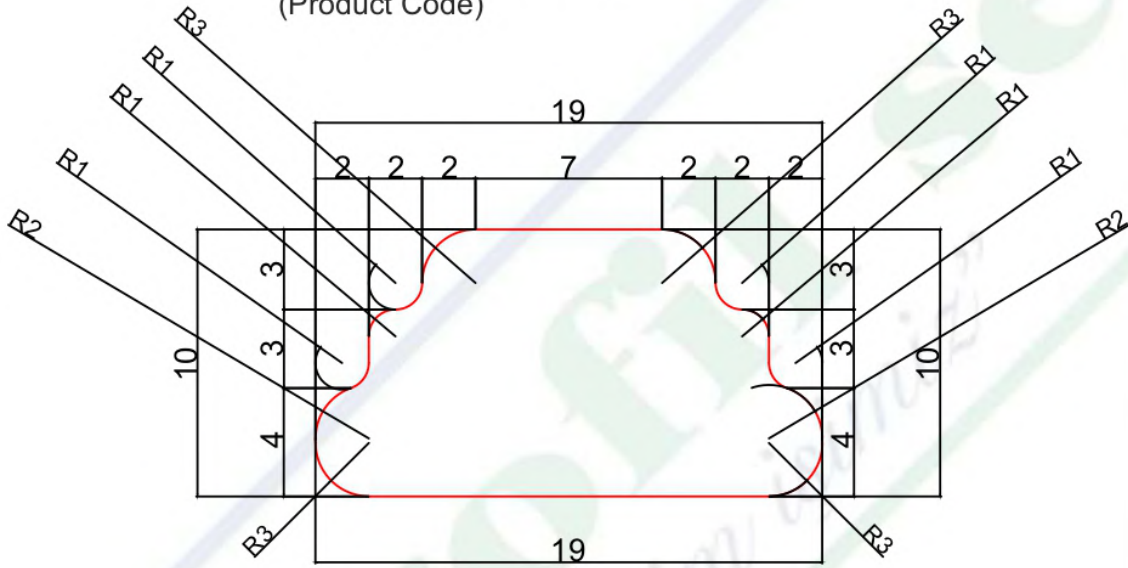

PVC BİTİŞ YERİ
(Pvc ending area)

BÖLÜM SORUMLUSU NEJDET ALTINTOPRAK	BU ÇİZİM PROFİLSE - SİLAS ORMAN ÜRÜNLERİ'NE AİTTİR. İZINSİZ ÇOĞALTILMAMAK VE KOPYA EDİLMEMEK ŞARTI İLE İZİN VERİLMİŞTİR.	PVC ENİ : MDF MİKTARI : PLAKADAN ÇIKAN :	KSM ÖLÇÜCÜ :	KUTU İÇİ : KUTU İÇİ ADET :
ARGE SORUMLUSU DOĞUKAN DEMİR	THIS DRAWING PROFILE - SİLAS FOREST PRODUCTS WHAT TO DO. UNLOCKED AND COPY NOT ALLOWED WITH THE WRITTEN.	GENEL TOLERANS : PROFİL BOY TOLERANSI :	MATERİYAL MM MDF	TARİH / DATE 08.04.2019

10 mm Profiles

PROFİLSE - SİLAS ORMAN ÜRÜNLERİ

KAĞIT ÜZERİNDEN ÖLÇÜ ALMAYINIZ !!!
Don't measurate on paper.

ÜRÜN KODU : 10*36
(Product Code)

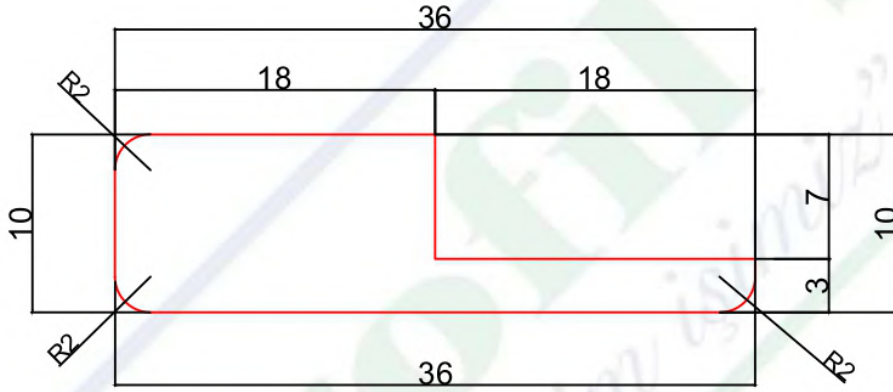

PVC BİTİŞ YERİ

(Pvc ending area)

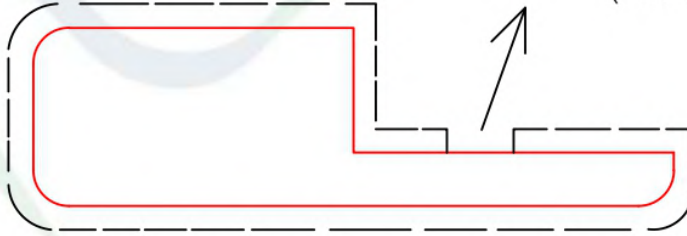

BÖLÜM SORUMLUSU NEJDET ALTINTOPRAK	BU ÇİZİM PROFİLSE - SİLAS ORMAN ÜRÜNLERİ'NE AİTTİR. İZINSİZ ÇOĞALTILMAMAK VE KOPYA EDİLMEKEMEK ŞARTI İLE İZİN VERİLMİŞTİR.	PVC ENİ : MDF MİKTARI : PLAKADAN ÇIKAN :	KSM ÖLÇÜCÜ :	KUTU İÇİ : KUTU İÇİ ADET :
ARGE SORUMLUSU DOĞUKAN DEMİR	THIS DRAWING PROFILE - SİLAS FOREST PRODUCTS WHAT TO DO. UNLOCKED AND COPY NOT ALLOWED WITH THE WRITTEN.	GENEL TOLERANS : PROFİL BOY TOLERANSI :	MATERIAL MM MDF	TARİH / DATE 10.04.2019

10 mm Profiles

PROFİLSE - SİLAS ORMAN ÜRÜNLERİ

KAĞIT ÜZERİNDEN ÖLÇÜ ALMAYINIZ !!!
Don't measurate on paper.

ÜRÜN KODU : 10*16

(Product Code)

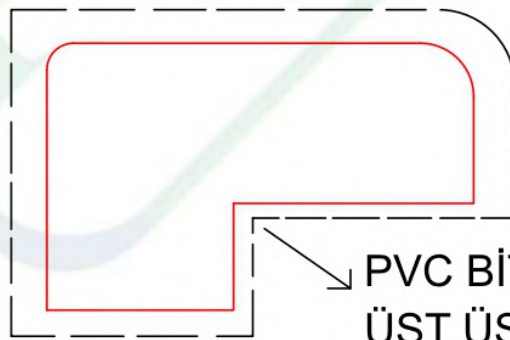
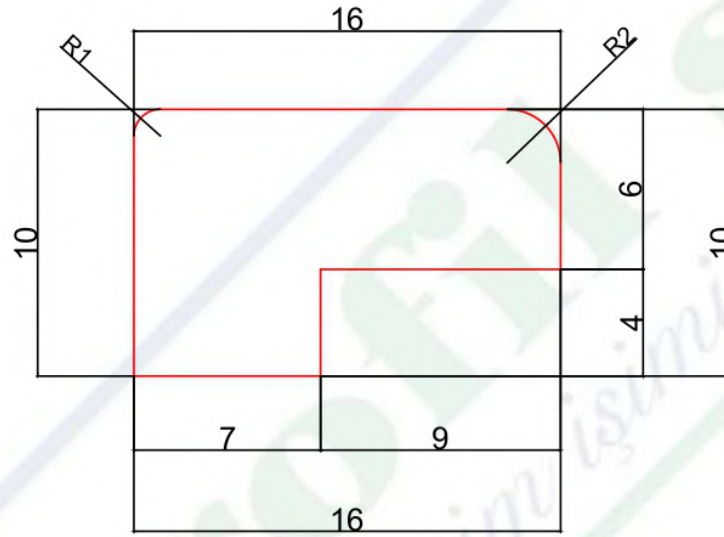

PVC BİTİŞ YERİ
ÜST ÜSTTE BİNİYOR
(Pvc ending area)

BÖLÜM SORUMLUSU NEJDET ALTINTOPRAK	BU ÇİZİM PROFİLSE - SİLAS ORMAN ÜRÜNLERİ'NE AİTTİR. İZINSİZ ÇOĞALTILMAMAK VE KOPYA EDİLMEK ŞARTI İLE İZİN VERİLMİŞTİR.	PVC ENİ : MDF MİKTARI : PLAKADAN ÇIKAN :	KSM ÖLÇÜCÜ :	KUTU İÇİ : KUTU İÇİ ADET :
ARGE SORUMLUSU DOĞUKAN DEMİR	THIS DRAWING PROFILE - SİLAS FOREST PRODUCTS WHAT TO DO. UNLOCKED AND COPY NOT ALLOWED WITH THE WRITTEN.	GENEL TOLERANS : PROFL BOY TOLERANSI :	MATERİYAL MM MDF	TARİH / DATE 17.04.2019

10 mm Profiles

PROFİLSE - SİLAS ORMAN ÜRÜNLERİ

KAĞIT ÜZERİNDEN ÖLÇÜ ALMAYINIZ !!!
Don't measure on paper.

ÜRÜN KODU : 10*32
(Product Code)

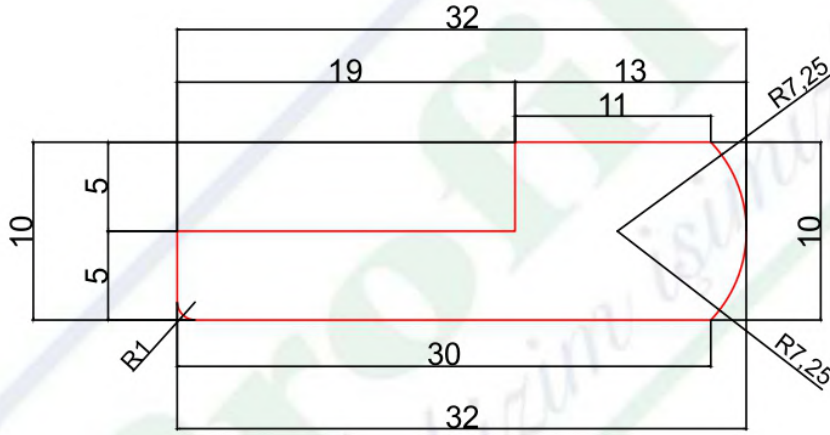

(Pvc ending area)

PVC BİTİŞ YERİ

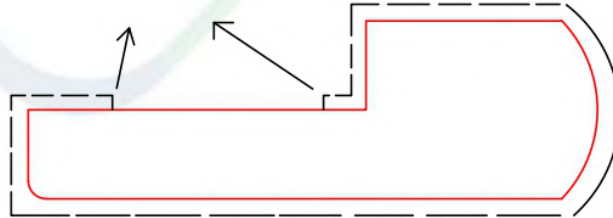

BÖLÜM SORUMLUSU NEJDET ALTINTOPRAK	BU ÇİZİM PROFİLSE - SİLAS ORMAN ÜRÜNLERİ'NE AİTTİR. İZİNSİZ ÇOĞALTILMAMAK VE KOPYA EDİLMEK ŞARTI İLE İZİN VERİLMİŞTİR.	PVC ENİ : MDF MİKTARI : PLAKADAN ÇIKAN :	KSM ÖLÇÜCÜ :	KUTU İÇİ : KUTU İÇİ ADET :
ARGE SORUMLUSU DOĞUKAN DEMİR	THIS DRAWING PROFILE - SİLAS FOREST PRODUCTS WHAT TO DO. UNLOCKED AND COPY NOT ALLOWED WITH THE WRITTEN.	GENEL TOLERANS : PROFL BOY TOLERANSI :	MATERİYAL MM MDF	TARİH / DATE 17.04.2019

10 mm Profiles

PROFİLSE - SİLAS ORMAN ÜRÜNLERİ

KAĞIT ÜZERİNDEN ÖLÇÜ ALMAYINIZ !!!

Don't measurate on paper.

ÜRÜN KODU : 10*10
(Product Code)

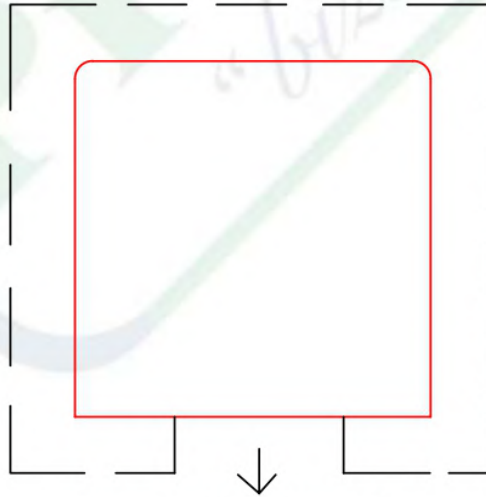
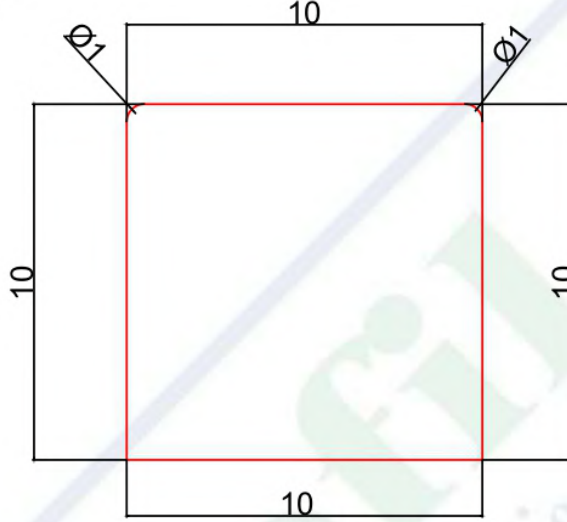

PVC BİTİŞ YERİ
(Pvc ending area)

BÖLÜM SORUMLUSU NEJDET ALTINTOPRAK	BU ÇİZİM PROFİLSE - SİLAS ORMAN ÜRÜNLERİ'NE AİTTİR. İZINSİZ ÇOĞALTILMAMAK VE KOPYA EDİLMEKEMEK ŞARTI İLE İZİN VERİLMİŞTİR.	PVC ENİ : MDF MİKTARI : PLAKADAN ÇIKAN :	KSM ÖLÇÜCÜ :	KUTU İÇİ : KUTU İÇİ ADET :
ARGE SORUMLUSU DOĞUKAN DEMİR	THIS DRAWING PROFILE - SİLAS FOREST PRODUCTS WHAT TO DO. UNLOCKED AND COPY NOT ALLOWED WITH THE WRITTEN.	GENEL TOLERANS : PROFİL BOY TOLERANSI :	MATERIAL MM MDF	TARİH / DATE 04.10.2018

10 mm Profiles

PROFİLSE - SİLAS ORMAN ÜRÜNLERİ

KAĞIT ÜZERİNDEN ÖLÇÜ ALMAYINIZ !!!
Don't measurate on paper.

ÜRÜN KODU : 10*37
(Product Code)

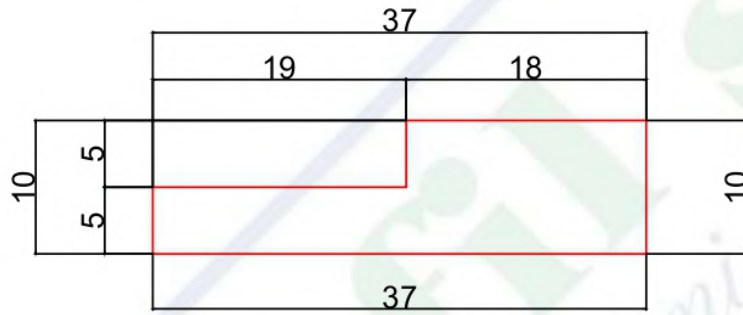

(Pvc ending area)
PVC BİTİŞ YERİ

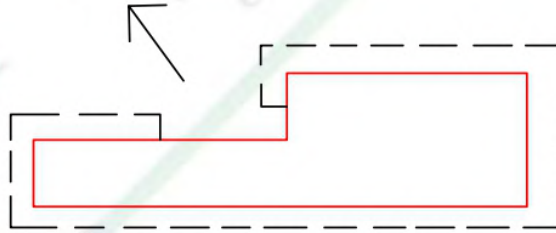

BÖLÜM SORUMLUSU NEJDET ALTINTOPRAK	BU ÇİZİM PROFİLSE - SİLAS ORMAN ÜRÜNLERİ'NE AİTTİR. İZINSİZ ÇOĞALTILMAMAK VE KOPYA EDİLMEKEMEK ŞARTI İLE İZİN VERİLMİŞTİR.	PVC ENİ : MDF MIKTARI : PLAKADAN ÇIKAN :	KSM ÖLÇÜCÜ :	KUTU İÇİ : KUTU İÇİ ADET :
ARGE SORUMLUSU DOĞUKAN DEMİR	THIS DRAWING PROFILE - SİLAS FOREST PRODUCTS WHAT TO DO. UNLOCKED AND COPY NOT ALLOWED WITH THE WRITTEN.	GENEL TOLERANS : PROFİL BOY TOLERANSI :	MATERİYAL MM MDF	TARİH / DATE 04.10.2018

10 mm Profiles

PROFİLSE - SİLAS ORMAN ÜRÜNLERİ

KAĞIT ÜZERİNDEN ÖLÇÜ ALMAYINIZ !!!

Don't measurate on paper.

ÜRÜN KODU : 10*12

(Product Code)

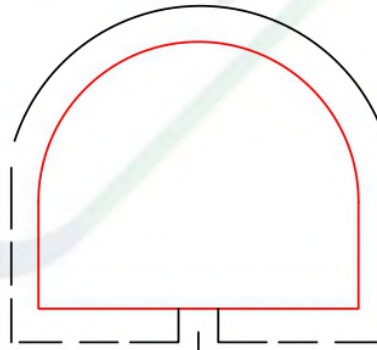
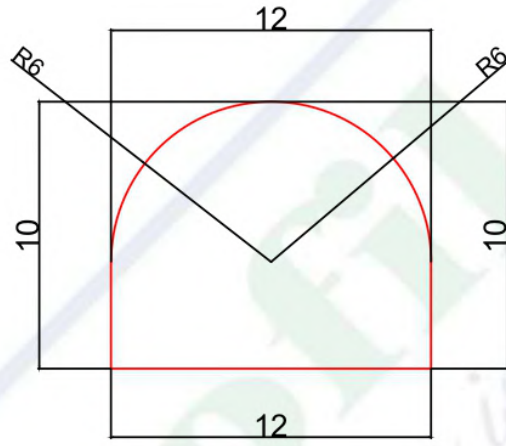

PVC BİTİŞ YERİ
(Pvc ending area)

BÖLÜM SORUMLUSU NEJDET ALTINTOPRAK	BU ÇİZİM PROFİLSE - SİLAS ORMAN ÜRÜNLERİ'NE AİTTİR. İZINSİZ ÇOĞALTILMAMAK VE KOPYA EDİLMEMEK ŞARTI İLE İZİN VERİLMİŞTİR.	PVC ENİ : MDF MİKTARI : PLAKADAN ÇIKAN :	KSM ÖLÇÜCÜ :	KUTU İÇİ : KUTU İÇİ ADET :
ARGE SORUMLUSU DOĞUKAN DEMİR	THIS DRAWING PROFILE - SİLAS FOREST PRODUCTS WHAT TO DO. UNLOCKED AND COPY NOT ALLOWED WITH THE WRITTEN.	GENEL TOLERANS : PROFİL BOY TOLERANSI :	MATERİYAL MM MDF	TARİH / DATE 21.01.2019

10 mm Profiles

PROFİLSE - SİLAS ORMAN ÜRÜNLERİ

KAĞIT ÜZERİNDEN ÖLÇÜ ALMAYINIZ !!!

Don't measurate on paper.

ÜRÜN KODU : 10*16-14

(Product Code)

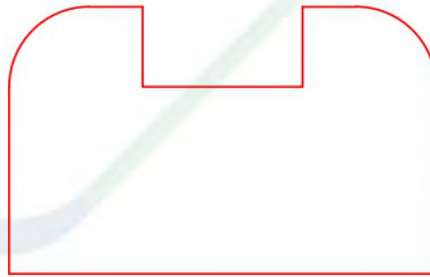
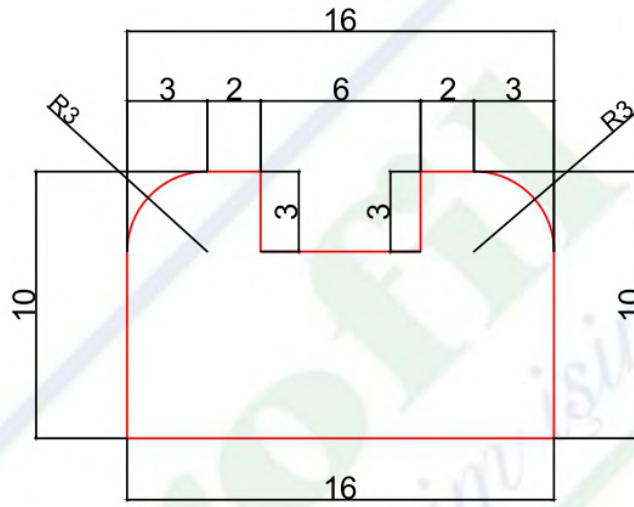

BÖLÜM SORUMLUSU NEJDET ALTINTOPRAK	BU ÇİZİM PROFİLSE - SİLAS ORMAN ÜRÜNLERİ'NE AİTTİR. İZINSİZ ÇOĞALTILMAMAK VE KOPYA EDİLMEK ŞARTI İLE İZİN VERİLMİŞTİR.	PVC ENİ : MDF MİKTARI : PLAKADAN ÇIKAN :	KSM ÖLÇÜCÜ :	KUTU İÇİ : KUTU İÇİ ADET :
ARGE SORUMLUSU DOĞUKAN DEMİR	THIS DRAWING PROFILE - SİLAS FOREST PRODUCTS WHAT TO DO. UNLOCKED AND COPY NOT ALLOWED WITH THE WRITTEN.	GENEL TOLERANS : PROFİL BOY TOLERANSI :	MATERİYAL MM MDF	TARİH / DATE 18.01.2019

10 mm Profiles

PROFİLSE - SİLAS ORMAN ÜRÜNLERİ

KAĞIT ÜZERİNDEN ÖLÇÜ ALMAYINIZ !!!
Don't measurate on paper.

ÜRÜN KODU : 10*10-14
(Product Code)

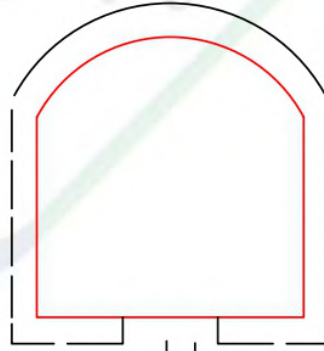
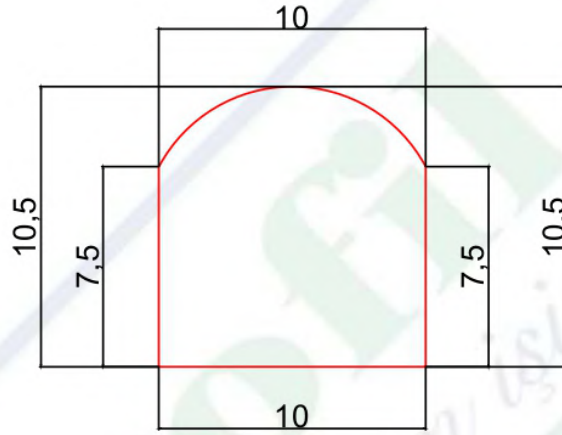

PVC BİTİM YERİ 2 MM BOŞLUK OLACAK

PVC BİTİŞ YERİ
(Pvc ending area)

BÖLÜM SORUMLUSU NEJDET ALTINTOPRAK	BU ÇİZİM PROFİLSE - SİLAS ORMAN ÜRÜNLERİ'NE AİTTİR. İZİNSİZ ÇOĞALTILMAMAK VE KOPYA EDİLMEMEK ŞARTI İLE İZİN VERİLMİŞTİR.	PVC ENİ : MDF MİKTARI : PLAKADAN ÇIKAN :	KSM ÖLÇÜCÜ :	KUTU İÇİ : KUTU İÇİ ADET :
ARGE SORUMLUSU DOĞUKAN DEMİR	THIS DRAWING PROFILE - SİLAS FOREST PRODUCTS WHAT TO DO. UNLOCKED AND COPY NOT ALLOWED WITH THE WRITTEN.	GENEL TOLERANS : PROFİL BOY TOLERANSI :	MATERİYAL MM MDF	TARİH / DATE 18.01.2019

10 mm Profiles

PROFİLSE - SİLAS ORMAN ÜRÜNLERİ

KAĞIT ÜZERİNDEN ÖLÇÜ ALMAYINIZ !!!

Don't measurate on paper.

ÜRÜN KODU : 10*20

(Product Code)

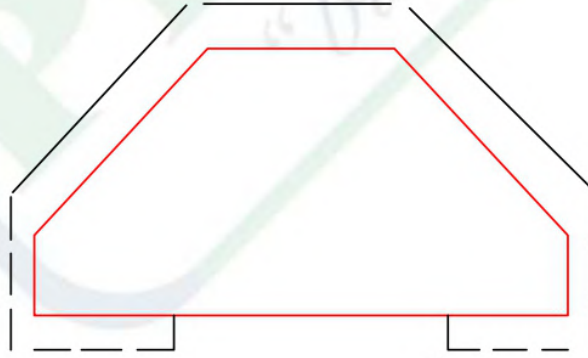
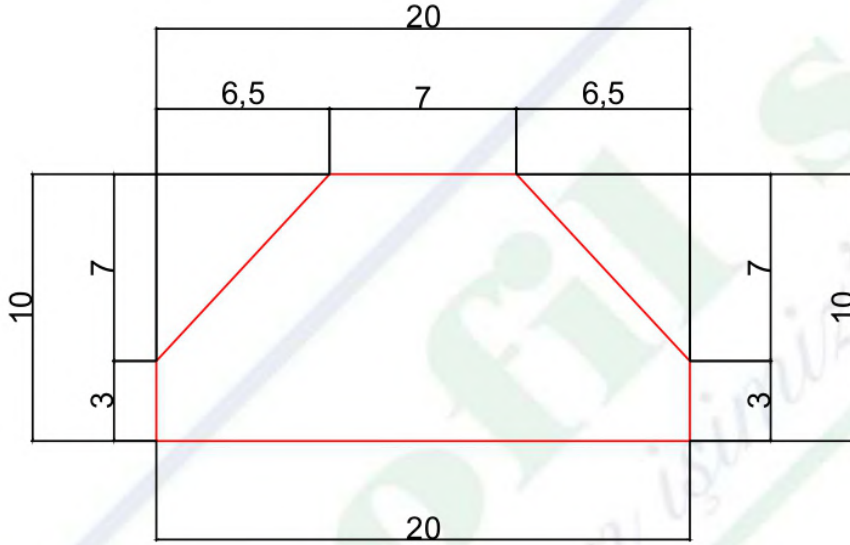

PVC BİTİŞ YERİ

(Pvc ending area)

BÖLÜM SORUMLUSU NEJDET ALTINTOPRAK	BU ÇİZİM PROFİLSE - SİLAS ORMAN ÜRÜNLERİ'NE AİTTİR. İZINSİZ ÇOĞALTILMAMAK VE KOPYA EDİLMEKEMEK ŞARTI İLE İZİN VERİLMİŞTİR.	PVC ENİ : MDF MİKTARI : PLAKADAN ÇIKAN :	KSM ÖLÇÜCÜ :	KUTU İÇİ : KUTU İÇİ ADET :
ARGE SORUMLUSU DOĞUKAN DEMİR	THIS DRAWING PROFILE - SİLAS FOREST PRODUCTS WHAT TO DO. UNLOCKED AND COPY NOT ALLOWED WITH THE WRITTEN.	GENEL TOLERANS : PROFL BOY TOLERANSI :	MATERİAL MM MDF	TARİH / DATE 12.11.2018

10 mm Profiles

PROFİLSE - SİLAS ORMAN ÜRÜNLERİ

KAĞIT ÜZERİNDEN ÖLÇÜ ALMAYINIZ !!!
Don't measure on paper.

ÜRÜN KODU : 10*28
(Product Code)

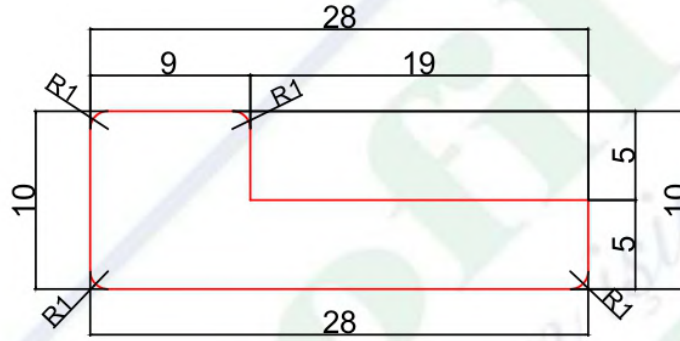

(Pvc ending area)
PVC BİTİŞ YERİ

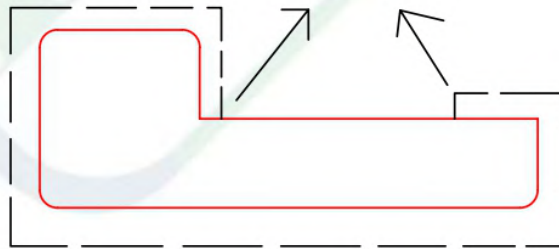

BÖLÜM SORUMLUSU NEJDET ALTINTOPRAK	BU ÇİZİM PROFİLSE - SİLAS ORMAN ÜRÜNLERİ'NE AİTTİR. İZİNSİZ ÇOĞALTILMAMAK VE KOPYA EDİLMEMEK ŞARTI İLE İZİN VERİLMİŞTİR.	PVC ENİ : MDF MİKTARI : PLAKADAN ÇIKAN :	KSM ÖLÇÜCÜ :	KUTU İÇİ : KUTU İÇİ ADET :
ARGE SORUMLUSU DOĞUKAN DEMİR	THIS DRAWING PROFILE - SİLAS FOREST PRODUCTS WHAT TO DO. UNLOCKED AND COPY NOT ALLOWED WITH THE WRITTEN.	GENEL TOLERANS : PROFL BOY TOLERANSI :	MATERİYAL MM MDF	TARİH / DATE 07.02.2019

10 mm Profiles

PROFİLSE - SİLAS ORMAN ÜRÜNLERİ

KAĞIT ÜZERİNDEN ÖLÇÜ ALMAYINIZ !!!

Don't measurate on paper.

ÜRÜN KODU : 10*12

(Product Code)

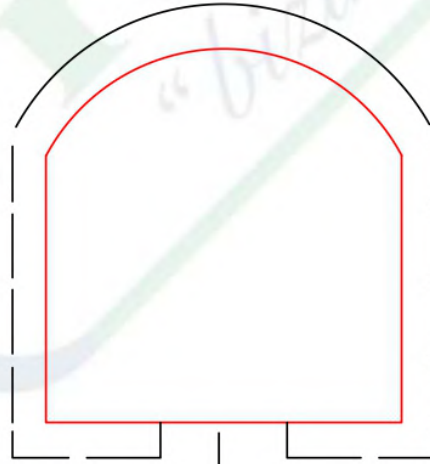
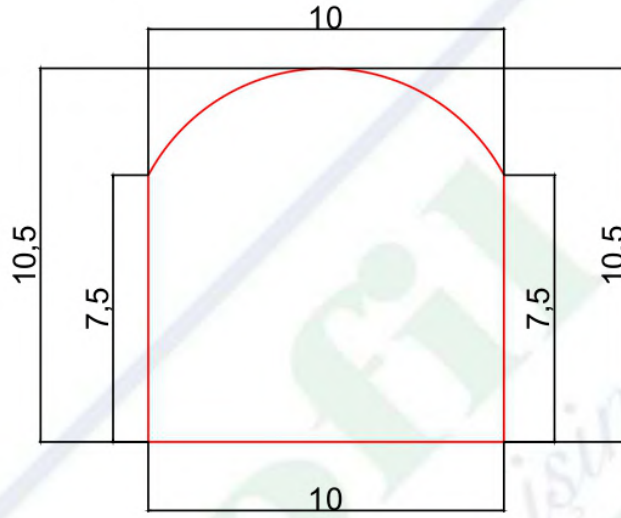

PVC BİTİŞ YERİ
(Pvc ending area)

BÖLÜM SORUMLUSU NEJDET ALTINTOPRAK	BU ÇİZİM PROFİLSE - SİLAS ORMAN ÜRÜNLERİ'NE AİTTİR. İZINSİZ ÇOĞALTILMAMAK VE KOPYA EDİLMEKEMEK ŞARTI İLE İZİN VERİLMİŞTİR.	PVC ENİ : MDF MİKTARI : PLAKADAN ÇIKAN :	KSM ÖLÇÜCÜ :	KUTU İÇİ : KUTU İÇİ ADET :
ARGE SORUMLUSU DOĞUKAN DEMİR	THIS DRAWING PROFILE - SILAS FOREST PRODUCTS WHAT TO DO. UNLOCKED AND COPY NOT ALLOWED WITH THE WRITTEN.	GENEL TOLERANS : PROFİL BOY TOLERANSI :	MATERİYAL MM MDF	TARİH / DATE 07.02.2019

10 mm Profiles

PROFİLSE - SİLAS ORMAN ÜRÜNLERİ

KAĞIT ÜZERİNDEN ÖLÇÜ ALMAYINIZ !!!
Don't measure on paper.

ÜRÜN KODU : 10*22
(Product Code)

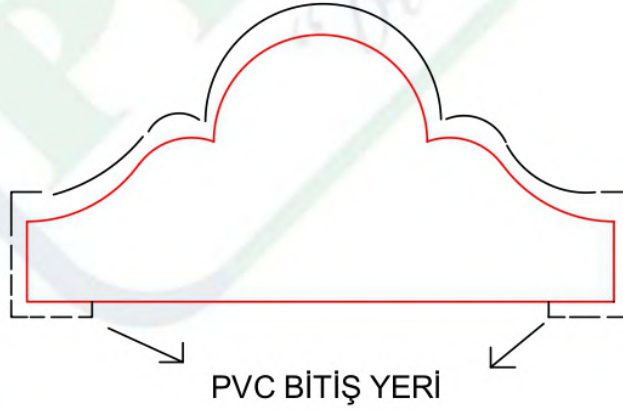
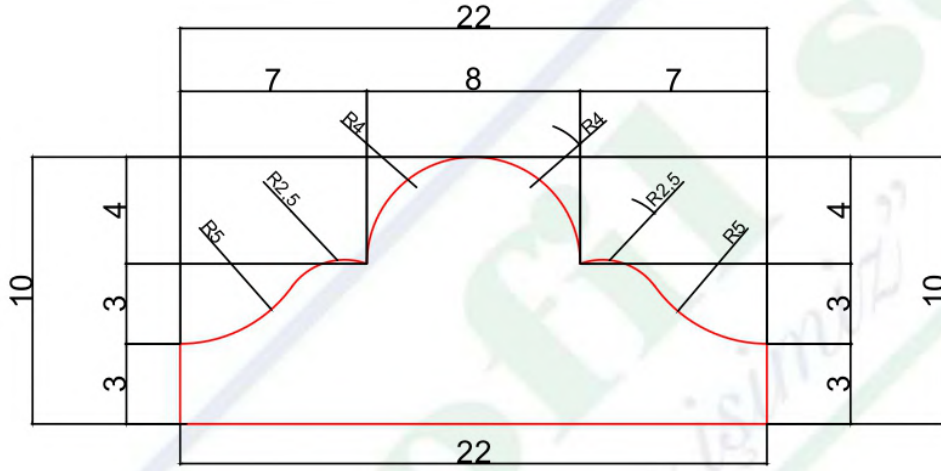

(Pvc ending area)

BÖLÜM SORUMLUSU NEJDET ALTINTOPRAK	BU ÇİZİM PROFİLSE - SİLAS ORMAN ÜRÜNLERİ'NE AİTTİR. İZINSİZ ÇOĞALTILMAMAK VE KOPYA EDİLMEMEK ŞARTI İLE İZİN VERİLMİŞTİR.	PVC ENİ : MDF MİKTARI : PLAKADAN ÇIKAN :	KSM ÖLÇÜCÜ :	KUTU İÇİ : KUTU İÇİ ADET :
ARGE SORUMLUSU DOĞUKAN DEMİR	THIS DRAWING PROFILE - SİLAS FOREST PRODUCTS WHAT TO DO. UNLOCKED AND COPY NOT ALLOWED WITH THE WRITTEN.	GENEL TOLERANS : PROFL BOY TOLERANSI :	MATERİYAL MM MDF	TARİH / DATE 06.12.2018

10 mm Profiles

PROFİLSE - SİLAS ORMAN ÜRÜNLERİ

KAĞIT ÜZERİNDEN ÖLÇÜ ALMAYINIZ !!!

Don't measurate on paper.

ÜRÜN KODU : 10*37
(Product Code)

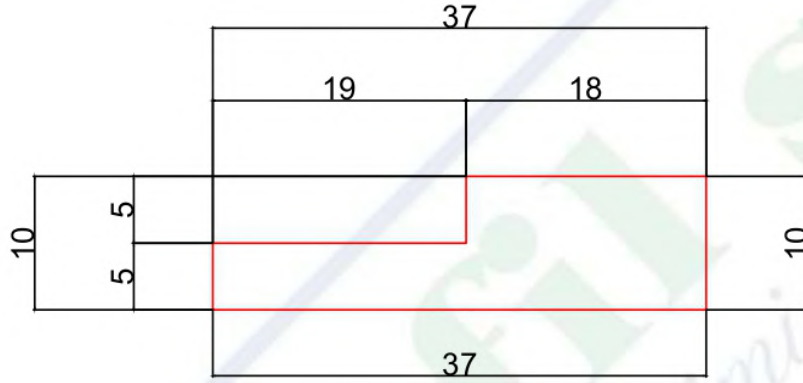

(Pvc ending area)

PVC BİTİŞ YERİ

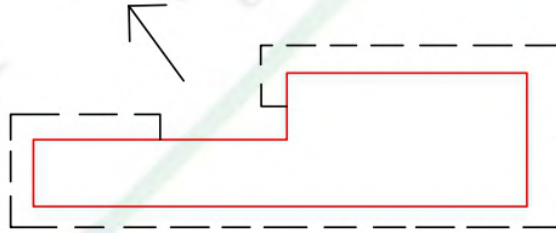

BÖLÜM SORUMLUSU NEJDET ALTINTOPRAK	BU ÇİZİM PROFİLSE - SİLAS ORMAN ÜRÜNLERİ'NE AİTTİR. İZINSİZ ÇOĞALTILMAMAK VE KOPYA EDİLMEKEMEK ŞARTI İLE İZİN VERİLMİŞTİR.	PVC ENİ : MDF MİKTARI : PLAKADAN ÇIKAN :	KSM ÖLÇÜCÜ :	KUTU İÇİ : KUTU İÇİ ADET :
ARGE SORUMLUSU DOĞUKAN DEMİR	THIS DRAWING PROFILE - SİLAS FOREST PRODUCTS WHAT TO DO. UNLOCKED AND COPY NOT ALLOWED WITH THE WRITTEN.	GENEL TOLERANS : PROFL BOY TOLERANSI :	MATERİYAL MM MDF	TARİH / DATE 14.11.2018

10 mm Profiles

PROFİLSE - SİLAS ORMAN ÜRÜNLERİ

ÜRÜN KODU : 10*25
(Product Code)

KAĞIT ÜZERİNDEN ÖLÇÜ ALMAYINIZ !!!
Don't measure on paper.

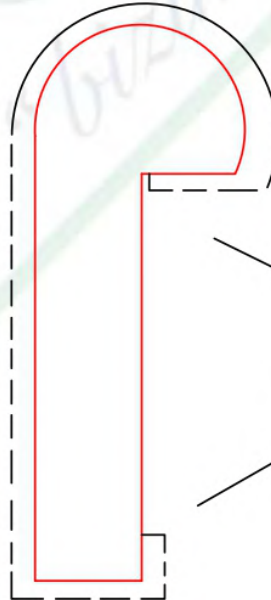
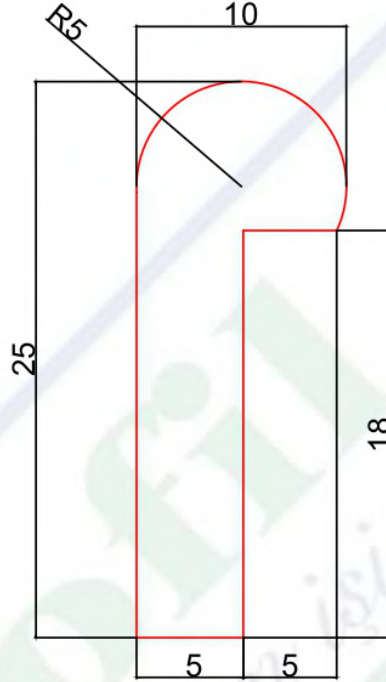

BÖLÜM SORUMLUSU NEJDET ALTINTOPRAK	BU ÇİZİM PROFİLSE - SİLAS ORMAN ÜRÜNLERİ'NE AİTTİR. İZİNSİZ ÇOĞALTILMAMAK VE KOPYA EDİLMEK ŞARTI İLE İZİN VERİLMİŞTİR.	PVC ENİ : MDF MİKTARI : PLAKADAN ÇIKAN :	KSM ÖLÇÜCÜ :	KUTU İÇİ : KUTU İÇİ ADET :
ARGE SORUMLUSU DOĞUKAN DEMİR	THIS DRAWING PROFILE - SİLAS FOREST PRODUCTS WHAT TO DO. UNLOCKED AND COPY NOT ALLOWED WITH THE WRITTEN.	GENEL TOLERANS : PROFİL BOY TOLERANSI :	MATERİYAL MM MDF	TARİH / DATE 04.10.2018

10 mm Profiles

PROFİLSE - SİLAS ORMAN ÜRÜNLERİ

KAĞIT ÜZERİNDEN ÖLÇÜ ALMAYINIZ !!!

Don't measurate on paper.

ÜRÜN KODU : 10*54

(Product Code)

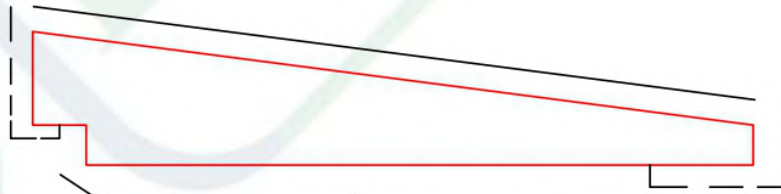

PVC BİTİŞ YERİ
(Pvc ending area)

BÖLÜM SORUMLUSU NEJDET ALTINTOPRAK	BU ÇİZİM PROFİLSE - SİLAS ORMAN ÜRÜNLERİ'NE AİTTİR. İZİNSİZ ÇOĞALTILMAMAK VE KOPYA EDİLMEMEK ŞARTI İLE İZİN VERİLMİŞTİR.	PVC ENİ : MDF MİKTARI : PLAKADAN ÇIKAN :	KSM ÖLÇÜCÜ :	KUTU İÇİ : KUTU İÇİ ADET :
ARGE SORUMLUSU DOĞUKAN DEMİR	THIS DRAWING PROFILE - SİLAS FOREST PRODUCTS WHAT TO DO. UNLOCKED AND COPY NOT ALLOWED WITH THE WRITTEN.	GENEL TOLERANS : PROFİL BOY TOLERANSI :	MATERIAL MM MDF	TARİH / DATE 04.10.2018

12 mm Profiles

PROFİLSE - SİLAS ORMAN ÜRÜNLERİ

KAĞIT ÜZERİNDEN ÖLÇÜ ALMAYINIZ !!!
Don't measure on paper.

ÜRÜN KODU: 12*25
(Product Code)

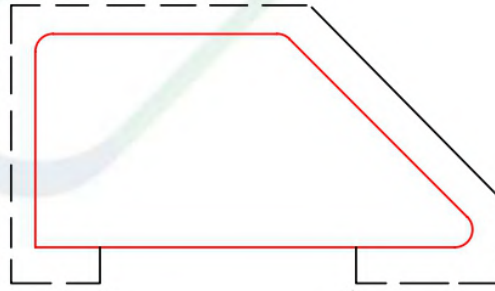
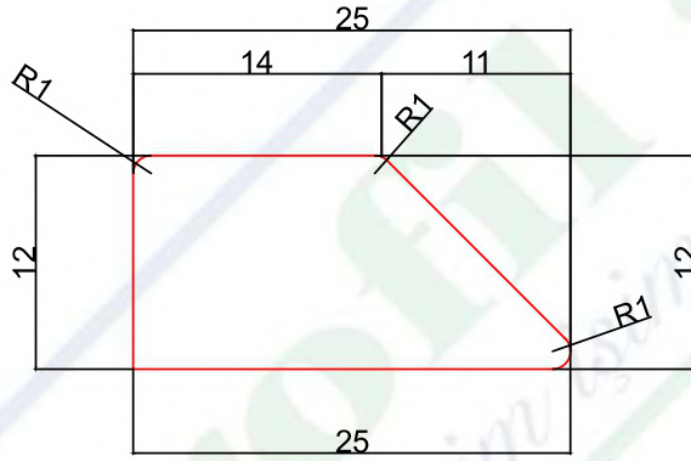

PVC BİTİŞ YERİ
(Pvc ending area)

BÖLÜM SORUMLUSU NEJDET ALTINTOPRAK	BU ÇİZİM PROFİLSE - SİLAS ORMAN ÜRÜNLERİ'NE AİTTİR. İZİNSİZ ÇOĞALTILMAMAK VE KOPYA EDİLMEMEK ŞARTI İLE İZİN VERİLMİŞTİR.	PVC ENİ : MDF MİKTARI : PLAKADAN ÇIKAN :	KSM ÖLÇÜCÜ :	KUTU İÇİ : KUTU İÇİ ADET :
ARGE SORUMLUSU DOĞUKAN DEMİR	THIS DRAWING PROFILE - SİLAS FOREST PRODUCTS WHAT TO DO. UNLOCKED AND COPY NOT ALLOWED WITH THE WRITTEN.	GENEL TOLERANS : PROFİL BOY TOLERANSI :	MATERİYAL MM MDF	TARİH / DATE 29.11.2018

12 mm Profiles

PROFİLSE - SİLAS ORMAN ÜRÜNLERİ

KAĞIT ÜZERİNDEN ÖLÇÜ ALMAYINIZ !!!
Don't measure on paper.

ÜRÜN KODU: 12*25
(Product Code)

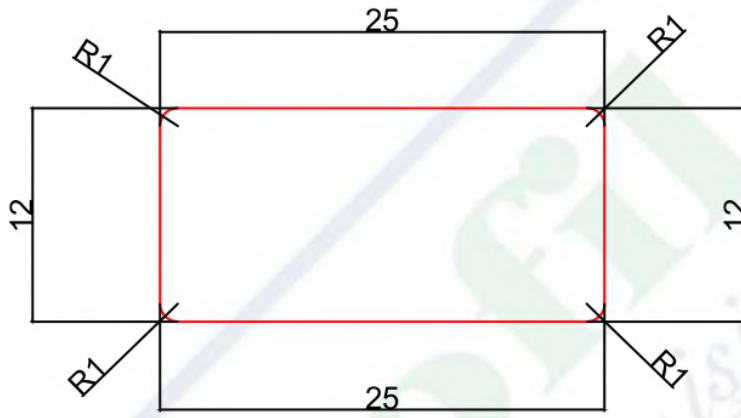

PVC BİTİŞ YERİ
(Pvc ending area)

BÖLÜM SORUMLUSU NEJDET ALTINTOPRAK	BU ÇİZİM PROFİLSE - SİLAS ORMAN ÜRÜNLERİ'NE AİTTİR. İZINSİZ ÇOĞALTILMAMAK VE KOPYA EDİLMEK ŞARTI İLE İZİN VERİLMİŞTİR.	PVC ENİ : MDF MİKTARI : PLAKADAN ÇIKAN :	KSM ÖLÇÜCÜ :	KUTU İÇİ : KUTU İÇİ ADET :
ARGE SORUMLUSU DOĞUKAN DEMİR	THIS DRAWING PROFILE - SİLAS FOREST PRODUCTS WHAT TO DO. UNLOCKED AND COPY NOT ALLOWED WITH THE WRITTEN.	GENEL TOLERANS : PROFL BOY TOLERANSI :	MATERİYAL MM MDF	TARİH / DATE 29.11.2018

12 mm Profiles

PROFİLSE - SİLAS ORMAN ÜRÜNLERİ

KAĞIT ÜZERİNDEN ÖLÇÜ ALMAYINIZ !!!

ÜRÜN KODU : 12*24

Don't measurate on paper.

(Product Code)

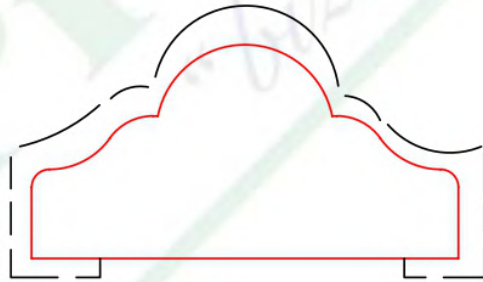
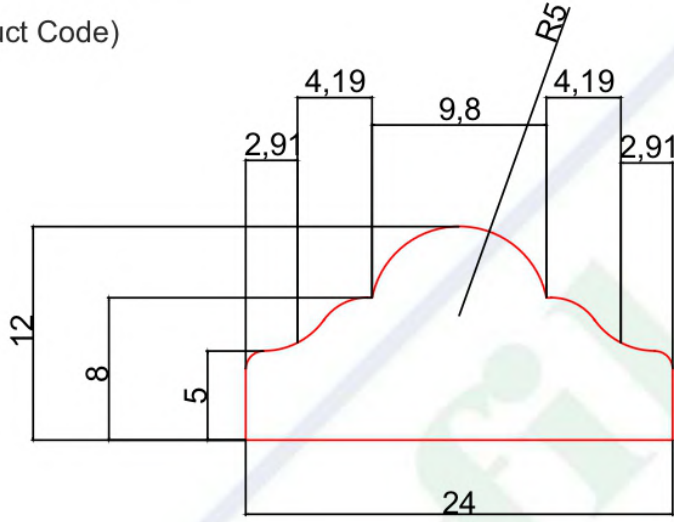

PVC BİTİŞ YERİ
(Pvc ending area)

BÖLÜM SORUMLUSU NEJDET ALTINTOPRAK	BU ÇİZİM PROFİLSE - SİLAS ORMAN ÜRÜNLERİ'NE AİTTİR. İZINSİZ ÇOĞALTILMAMAK VE KOPYA EDİLMEMEK ŞARTI İLE İZİN VERİLMİŞTİR.	PVC ENİ : MDF MİKTARI : PLAKADAN ÇIKAN :	KSM ÖLÇÜCÜ :	KUTU İÇİ : KUTU İÇİ ADET :
ARGE SORUMLUSU DOĞUKAN DEMİR	THIS DRAWING PROFILE - SİLAS FOREST PRODUCTS WHAT TO DO. UNLOCKED AND COPY NOT ALLOWED WITH THE WRITTEN.	GENEL TOLERANS : PROFİL BOY TOLERANSI :	MATERİYAL MM MDF	TARİH / DATE 5.11.2018

12 mm Profiles

PROFİLSE - SİLAS ORMAN ÜRÜNLERİ

KAĞIT ÜZERİNDEN ÖLÇÜ ALMAYINIZ !!!
Don't measure on paper.

ÜRÜN KODU : 12*64

(Product Code)



PVC BİTİŞ YERİ
(Pvc ending area)

BÖLÜM SORUMLUSU NEJDET ALTINTOPRAK	BU ÇİZİM PROFİLSE - SİLAS ORMAN ÜRÜNLERİ'NE AİTTİR. İZİNSİZ ÇOĞALTILMAMAK VE KOPYA EDİLMEMEK ŞARTI İLE İZİN VERİLMİŞTİR.	PVC ENİ : MDF MİKTARI : PLAKADAN ÇIKAN :	KSM ÖLÇÜCÜ :	KUTU İÇİ : KUTU İÇİ ADET :
ARGE SORUMLUSU DOĞUKAN DEMİR	THIS DRAWING PROFILE - SİLAS FOREST PRODUCTS WHAT TO DO. UNLOCKED AND COPY NOT ALLOWED WITH THE WRITTEN.	GENEL TOLERANS : PROFİL BOY TOLERANSI :	MATERİYAL MM MDF	TARİH / DATE 10.12.2018

12 mm Profiles

PROFİLSE - SİLAS ORMAN ÜRÜNLERİ

KAĞIT ÜZERİNDEN ÖLÇÜ ALMAYINIZ !!!
Don't measure on paper.

ÜRÜN KODU : 12*100
(Product Code)

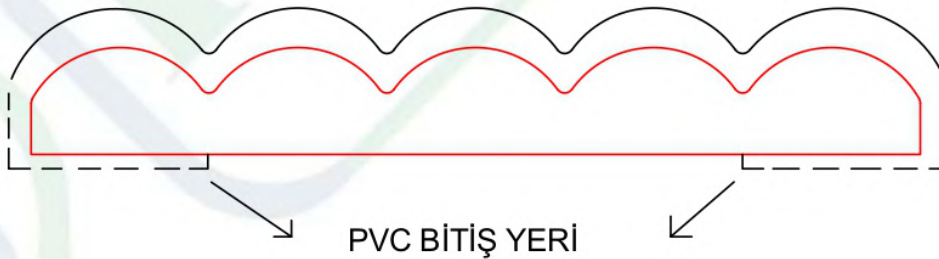
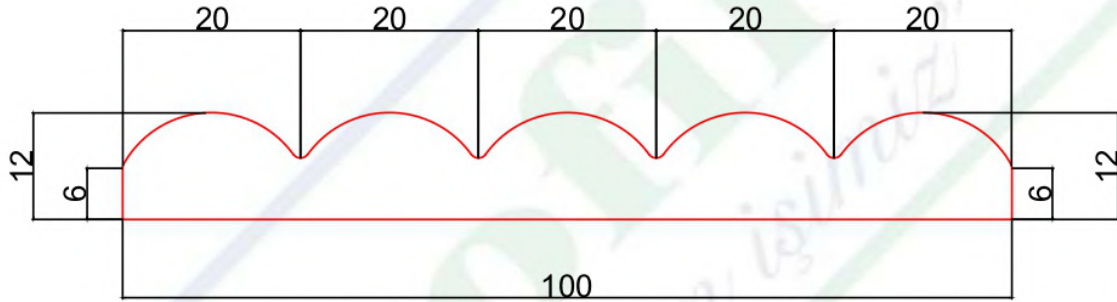

(Pvc ending area)

BÖLÜM SORUMLUSU NEJDET ALTINTOPRAK	BU ÇİZİM PROFİLSE - SİLAS ORMAN ÜRÜNLERİ'NE AİTTİR. İZİNSİZ ÇOĞALTILMAMAK VE KOPYA EDİLMEMEK ŞARTI İLE İZİN VERİLMİŞTİR.	PVC ENİ : MDF MIKTARI : PLAKADAN ÇIKAN :	KSM ÖLÇÜCÜ :	KUTU İÇİ : KUTU İÇİ ADET :
ARGE SORUMLUSU DOĞUKAN DEMİR	THIS DRAWING PROFILE - SİLAS FOREST PRODUCTS WHAT TO DO. UNLOCKED AND COPY NOT ALLOWED WITH THE WRITTEN.	GENEL TOLERANS : PROFİL BOY TOLERANSI :	MATERIAL MM MDF	TARİH / DATE 19.11.2018

12 mm Profiles

PROFİLSE - SİLAS ORMAN ÜRÜNLERİ

KAĞIT ÜZERİNDEN ÖLÇÜ ALMAYINIZ !!!

Don't measurate on paper.

ÜRÜN KODU : 12*60

(Product Code)

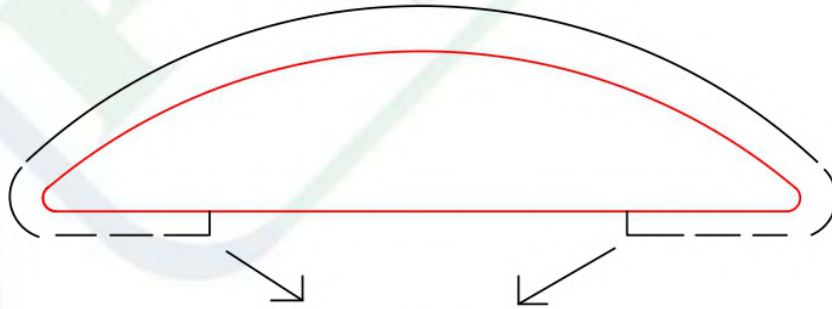
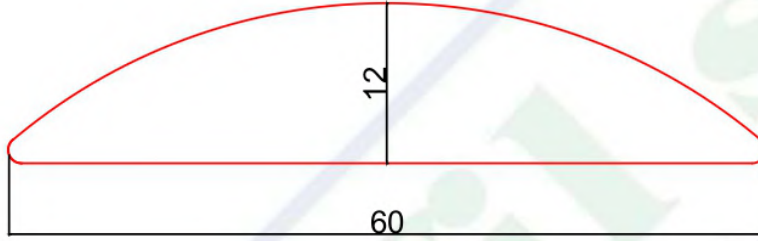

PVC BİTİŞ YERİ

(Pvc ending area)

BÖLÜM SORUMLUSU NEJDET ALTINTOPRAK	BU ÇİZİM PROFİLSE - SİLAS ORMAN ÜRÜNLERİ'NE AİTTİR. İZİNSİZ ÇOĞALTILMAMAK VE KOPYA EDİLMEKEMEK ŞARTI İLE İZİN VERİLMİŞTİR.	PVC ENİ : MDF MİKTARI : PLAKADAN ÇIKAN :	KSM ÖLÇÜCÜ :	KUTU İÇİ : KUTU İÇİ ADET :
ARGE SORUMLUSU DOĞUKAN DEMİR	THIS DRAWING PROFILE - SİLAS FOREST PRODUCTS WHAT TO DO. UNLOCKED AND COPY NOT ALLOWED WITH THE WRITTEN.	GENEL TOLERANS : PROFİL BOY TOLERANSI :	MATERİAL MM MDF	TARİH / DATE 12.10.2018

12 mm Profiles

PROFİLSE - SİLAS ORMAN ÜRÜNLERİ

KAĞIT ÜZERİNDEN ÖLÇÜ ALMAYINIZ !!!
Don't measurate on paper.

ÜRÜN KODU : 12*35
(Product Code)

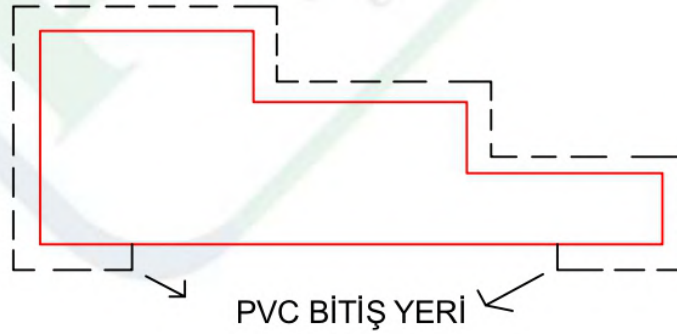
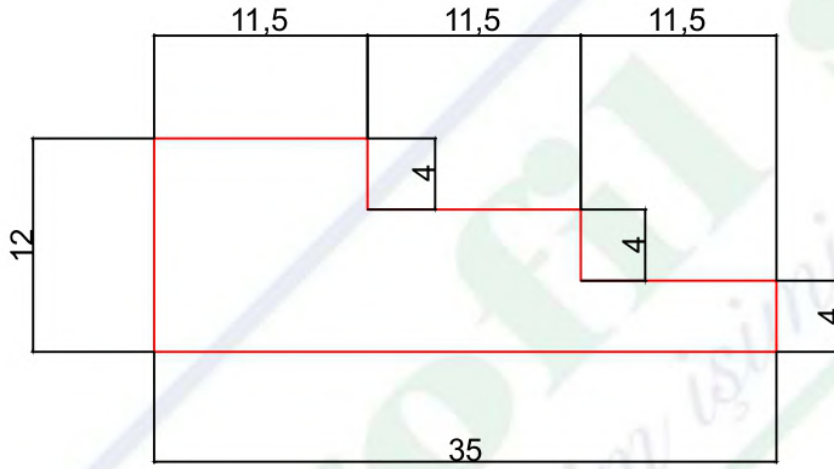

(Pvc ending area)

BÖLÜM SORUMLUSU NEJDET ALTINTOPRAK	BU ÇİZİM PROFİLSE - SİLAS ORMAN ÜRÜNLERİ'NE AİTTİR. İZINSİZ ÇOĞALTILMAMAK VE KOPYA EDİLMEMEK ŞARTI İLE İZİN VERİLMİŞTİR.	PVC ENİ : MDF MİKTARI : PLAKADAN ÇIKAN :	KSM ÖLÇÜCÜ :	KUTU İÇİ : KUTU İÇİ ADET :
ARGE SORUMLUSU DOĞUKAN DEMİR	THIS DRAWING PROFILE - SİLAS FOREST PRODUCTS WHAT TO DO. UNLOCKED AND COPY NOT ALLOWED WITH THE WRITTEN.	GENEL TOLERANS : PROFİL BOY TOLERANSI :	MATERİYAL MM MDF	TARİH / DATE 19.11.2018

12 mm Profiles

PROFİLSE - SİLAS ORMAN ÜRÜNLERİ

KAĞIT ÜZERİNDEN ÖLÇÜ ALMAYINIZ !!!
Don't measurate on paper.

ÜRÜN KODU : 12*19
(Product Code)

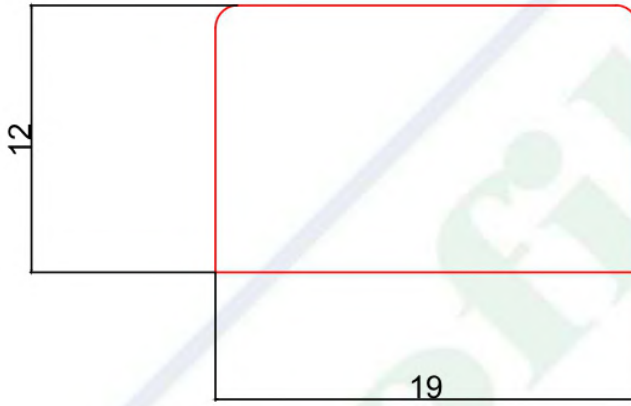

PVC BİTİŞ YERİ

(Pvc ending area)

BÖLÜM SORUMLUSU NEJDET ALTINTOPRAK	BU ÇİZİM PROFİLSE - SİLAS ORMAN ÜRÜNLERİ'NE AİTTİR. İZINSİZ ÇOĞALTILMAMAK VE KOPYA EDİLMEMEK ŞARTI İLE İZİN VERİLMİŞTİR.	PVC ENİ : MDF MİKTARI : PLAKADAN ÇIKAN :	KSM ÖLÇÜCÜ :	KUTU İÇİ : KUTU İÇİ ADET :
ARGE SORUMLUSU DOĞUKAN DEMİR	THIS DRAWING PROFILE - SİLAS FOREST PRODUCTS WHAT TO DO. UNLOCKED AND COPY NOT ALLOWED WITH THE WRITTEN.	GENEL TOLERANS : PROFİL BOY TOLERANSI :	MATERİYAL MM MDF	TARİH / DATE 10.10.2018

12 mm Profiles

PROFİLSE - SİLAS ORMAN ÜRÜNLERİ

KAĞIT ÜZERİNDEN ÖLÇÜ ALMAYINIZ !!!

Don't measurate on paper.

ÜRÜN KODU : 12*12

(Product Code)

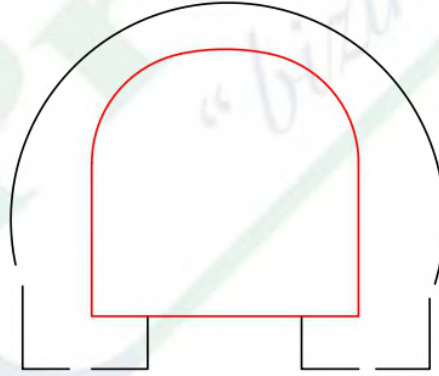
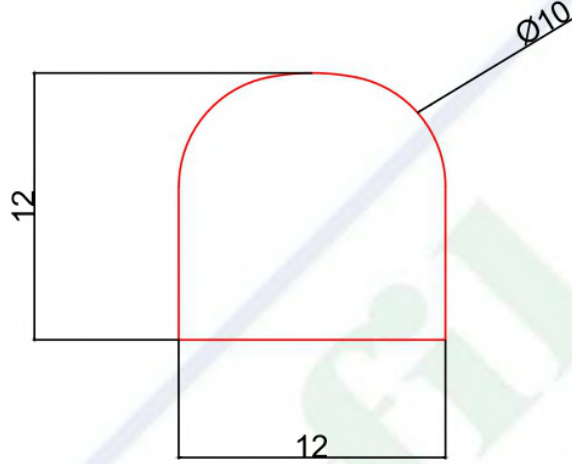

PVC BITİŞ YERİ
(Pvc ending area)

BÖLÜM SORUMLUSU NEJDET ALTINTOPRAK	BU ÇİZİM PROFİLSE - SİLAS ORMAN ÜRÜNLERİ'NE AİTTİR. İZİNSİZ ÇOĞALTILMAMAK VE KOPYA EDİLMEKEMEK ŞARTI İLE İZİN VERİLMİŞTİR.	PVC ENİ : MDF MİKTARI : PLAKADAN ÇIKAN :	KSM ÖLÇÜCÜ :	KUTU İÇİ : KUTU İÇİ ADET :
ARGE SORUMLUSU DOĞUKAN DEMİR	THIS DRAWING PROFILE - SİLAS FOREST PRODUCTS WHAT TO DO. UNLOCKED AND COPY NOT ALLOWED WITH THE WRITTEN.	GENEL TOLERANS : PROFİL BOY TOLERANSI :	MATERIAL MM MDF	TARİH / DATE 10.09.2018

12 mm Profiles

PROFİLSE - SİLAS ORMAN ÜRÜNLERİ

KAĞIT ÜZERİNDEN ÖLÇÜ ALMAYINIZ !!!

Don't measurate on paper.

ÜRÜN KODU : 12*16

(Product Code)

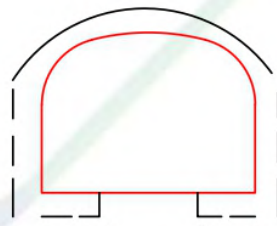
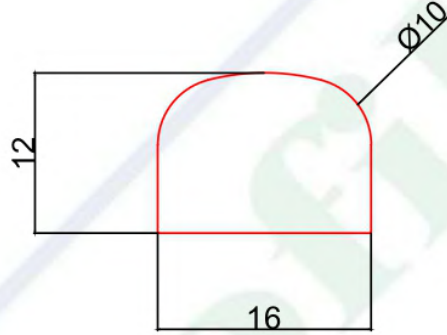

PVC BİTİŞ YERİ
(Pvc ending area)

BÖLÜM SORUMLUSU NEJDET ALTINTOPRAK	BU ÇİZİM PROFİLSE - SİLAS ORMAN ÜRÜNLERİ'NE AİTTİR. İZİNSİZ ÇOĞALTILMAMAK VE KOPYA EDİLMEMEK ŞARTI İLE İZİN VERİLMİŞTİR.	PVC ENİ : MDF MİKTARI : PLAKADAN ÇIKAN :	KSM ÖLÇÜCÜ :	KUTU İÇİ : KUTU İÇİ ADET :
ARGE SORUMLUSU DOĞUKAN DEMİR	THIS DRAWING PROFILE - SİLAS FOREST PRODUCTS WHAT TO DO. UNLOCKED AND COPY NOT ALLOWED WITH THE WRITTEN.	GENEL TOLERANS : PROFİL BOY TOLERANSI :	MATERİYAL MM MDF	TARİH / DATE 10.09.2018

12 mm Profiles

PROFİLSE - SİLAS ORMAN ÜRÜNLERİ

KAĞIT ÜZERİNDEN ÖLÇÜ ALMAYINIZ !!!

Don't measurate on paper.

ÜRÜN KODU : 12*18
(Product Code)

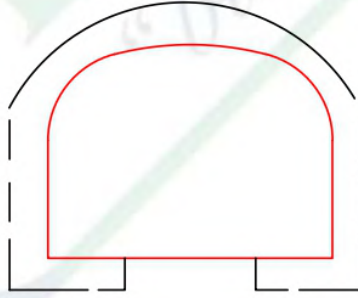
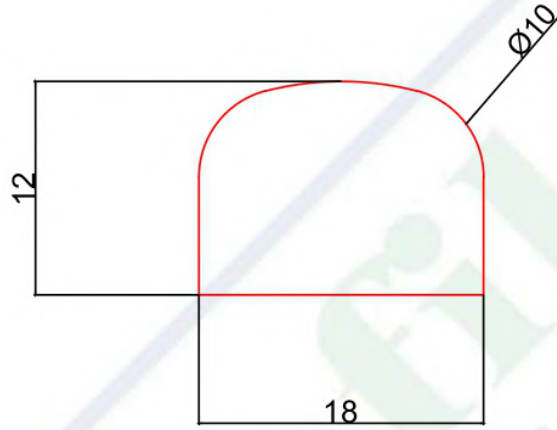

PVC BİTİŞ YERİ
(Pvc ending area)

BÖLÜM SORUMLUSU NEJDET ALTINTOPRAK	BU ÇİZİM PROFİLSE - SİLAS ORMAN ÜRÜNLERİ'NE AİTTİR. İZINSİZ ÇOĞALTILMAMAK VE KOPYA EDİLMEMEK ŞARTI İLE İZİN VERİLMİŞTİR.	PVC ENİ : MDF MİKTARI : PLAKADAN ÇIKAN :	KSM ÖLÇÜCÜ :	KUTU İÇİ : KUTU İÇİ ADET :
ARGE SORUMLUSU DOĞUKAN DEMİR	THIS DRAWING PROFILE - SILAS FOREST PRODUCTS WHAT TO DO. UNLOCKED AND COPY NOT ALLOWED WITH THE WRITTEN.	GENEL TOLERANS : PROFL BOY TOLERANSI :	MATERİAL MM MDF	TARİH / DATE 10.09.2018

12 mm Profiles

PROFİLSE - SİLAS ORMAN ÜRÜNLERİ

KAĞIT ÜZERİNDEN ÖLÇÜ ALMAYINIZ !!!

Don't measurate on paper.

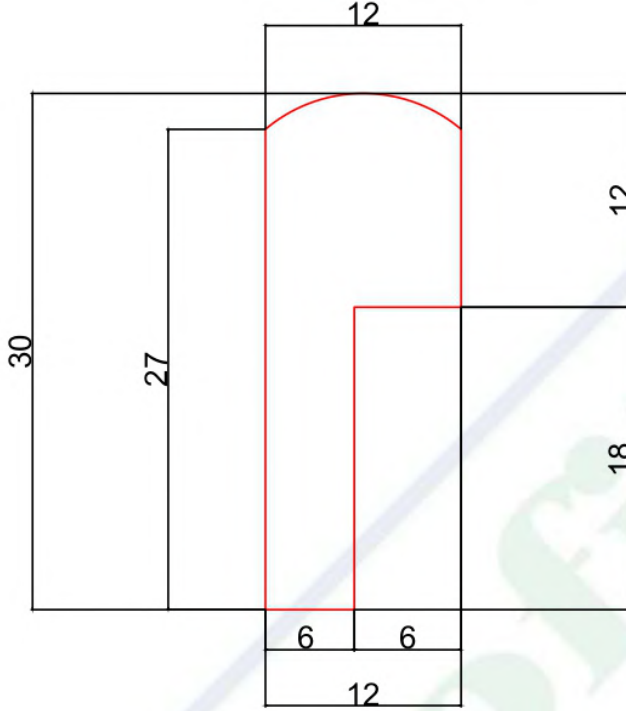

ÜRÜN KODU : 12*30

(Product Code)

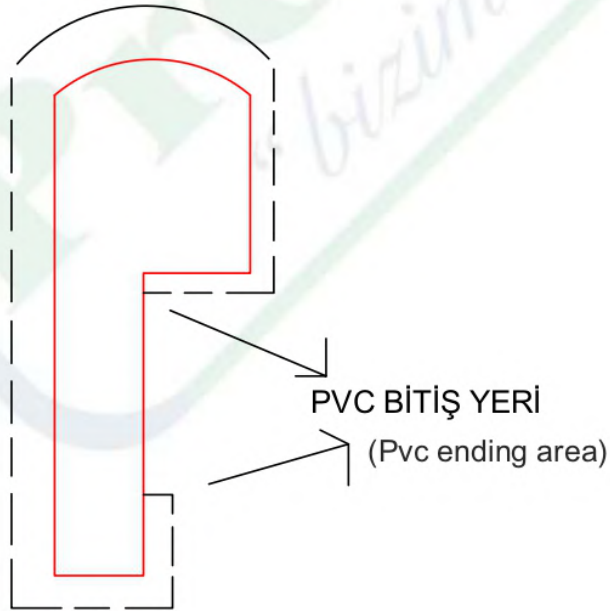

BÖLÜM SORUMLUSU NEJDET ALTINTOPRAK	BU ÇİZİM PROFİLSE - SİLAS ORMAN ÜRÜNLERİ'NE AİTTİR. İZINSİZ ÇOĞALTILMAMAK VE KOPYA EDİLMEMEK ŞARTI İLE İZİN VERİLMİŞTİR.	PVC ENİ : MDF MİKTARI : PLAKADAN ÇIKAN :	KSM ÖLÇÜCÜ :	KUTU İÇİ : KUTU İÇİ ADET :
ARGE SORUMLUSU DOĞUKAN DEMİR	THIS DRAWING PROFILE - SILAS FOREST PRODUCTS WHAT TO DO. UNLOCKED AND COPY NOT ALLOWED WITH THE WRITTEN.	GENEL TOLERANS : PROFL BOY TOLERANSI :	MATERİYAL MM MDF	TARİH / DATE 12.10.2018

12 mm Profiles

PROFİLSE - SİLAS ORMAN ÜRÜNLERİ

KAĞIT ÜZERİNDEN ÖLÇÜ ALMAYINIZ !!!

Don't measurate on paper.

ÜRÜN KODU : 12*42

(Product Code)

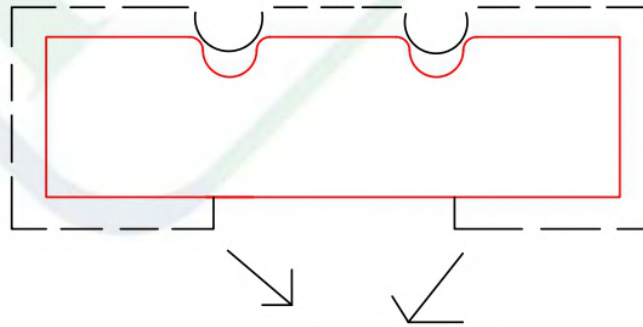
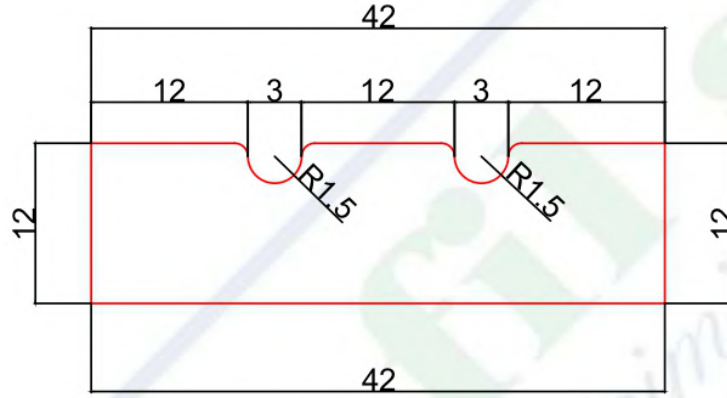

PVC BİTİŞ YERİ
(Pvc ending area)

BÖLÜM SORUMLUSU NEJDET ALTINTOPRAK	BU ÇİZİM PROFİLSE - SİLAS ORMAN ÜRÜNLERİ'NE AİTTİR. İZİNSİZ ÇOĞALTILMAMAK VE KOPYA EDİLMEKEMEK ŞARTI İLE İZİN VERİLMİŞTİR.	PVC ENİ : MDF MİKTARI : PLAKADAN ÇIKAN :	KSM ÖLÇÜCÜ :	KUTU İÇİ : KUTU İÇİ ADET :
ARGE SORUMLUSU DOĞUKAN DEMİR	THIS DRAWING PROFILE - SİLAS FOREST PRODUCTS WHAT TO DO. UNLOCKED AND COPY NOT ALLOWED WITH THE WRITTEN.	GENEL TOLERANS : PROFL BOY TOLERANSI :	MATERİYAL MM MDF	TARİH / DATE 12.10.2018

12 mm Profiles

PROFİLSE - SİLAS ORMAN ÜRÜNLERİ

KAĞIT ÜZERİNDEN ÖLÇÜ ALMAYINIZ !!!

Don't measurate on paper.

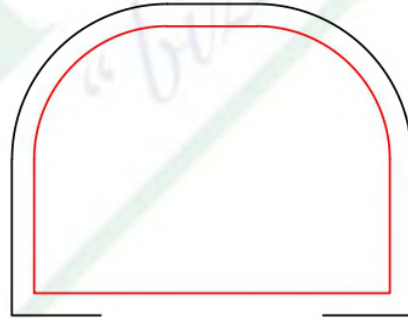
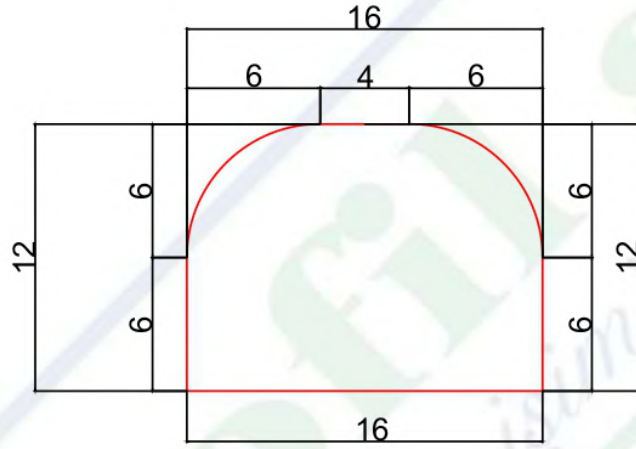

(Pvc ending area)

BÖLÜM SORUMLUSU NEJDET ALTINTOPRAK	BU ÇİZİM PROFİLSE - SİLAS ORMAN ÜRÜNLERİ 'NE AİTTİR. İZINSİZ ÇOĞALTILMAMAK VE KOPYA EDİLMEKEMEK ŞARTI İLE İZİN VERİLMİŞTİR.	PVC ENİ : MDF MİKTARI : PLAKADAN ÇIKAN :	KSM ÖLÇÜCÜ :	KUTU İÇİ : KUTU İÇİ ADET :
ARGE SORUMLUSU DOĞUKAN DEMİR	THIS DRAWING PROFILE - SİLAS FOREST PRODUCTS WHAT TO DO. UNLOCKED AND COPY NOT ALLOWED WITH THE WRITTEN.	GENEL TOLERANS : PROFL BOY TOLERANSI :	MATERİAL MM MDF	TARİH / DATE 25.09.2018

12 mm Profiles

PROFİLSE - SİLAS ORMAN ÜRÜNLERİ

KAĞIT ÜZERİNDEN ÖLÇÜ ALMAYINIZ !!!
Don't measurate on paper.

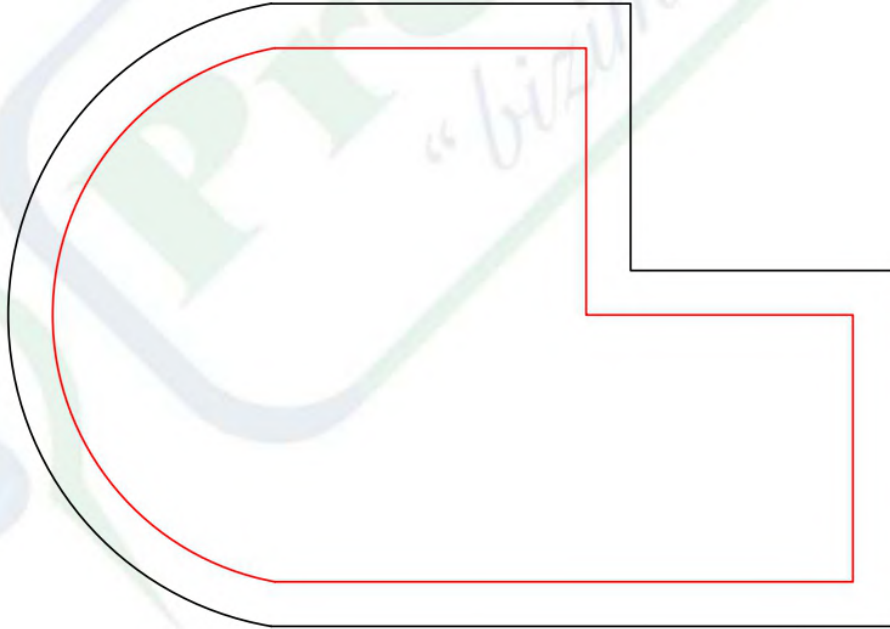
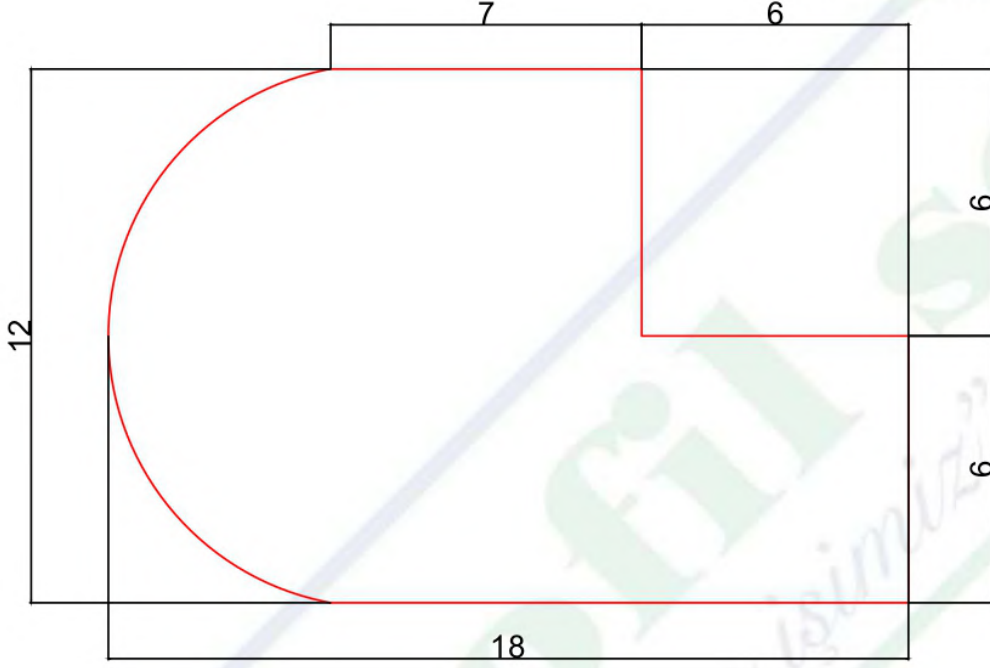

BÖLÜM SORUMLUSU NEJDET ALTINTOPRAK	BU ÇİZİM PROFİLSE - SİLAS ORMAN ÜRÜNLERİ'NE AİTTİR. İZINSİZ ÇOĞALTILMAMAK VE KOPYA EDİLMEMEK ŞARTI İLE İZİN VERİLMİŞTİR.	PVC ENİ : MDF MİKTARI : PLAKADAN ÇIKAN :	KSM ÖLÇÜCÜ :	KUTU İÇİ : KUTU İÇİ ADET :
ARGE SORUMLUSU DOĞUKAN DEMİR	THIS DRAWING PROFILE - SİLAS FOREST PRODUCTS WHAT TO DO. UNLOCKED AND COPY NOT ALLOWED WITH THE WRITTEN.	GENEL TOLERANS : PROFİL BOY TOLERANSI :	MATERİYAL MM MDF	TARİH / DATE 20.09.2018

12 mm Profiles

PROFİLSE - SİLAS ORMAN ÜRÜNLERİ

KAĞIT ÜZERİNDEN ÖLÇÜ ALMAYINIZ !!!
Don't measure on paper.

ÜRÜN KODU : 12*36
(Product Code)

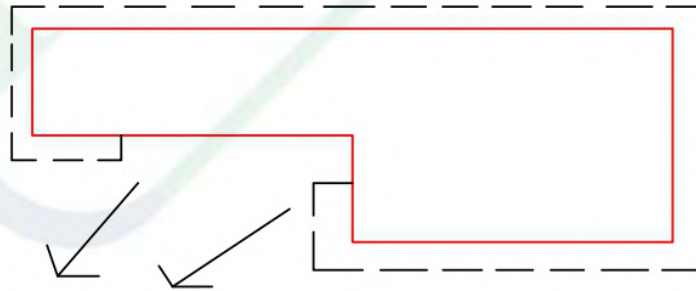
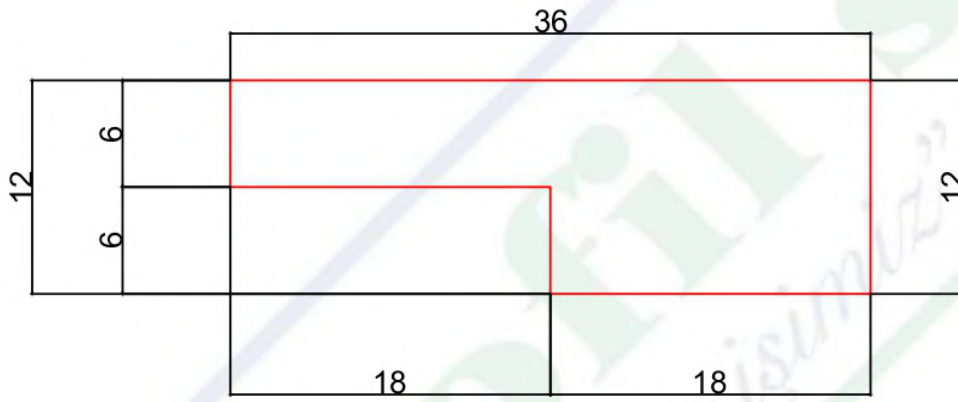

PVC BİTİŞ YERİ

(Pvc ending area)

BÖLÜM SORUMLUSU NEJDET ALTINTOPRAK	BU ÇİZİM PROFİLSE - SİLAS ORMAN ÜRÜNLERİ'NE AİTTİR. İZİNSİZ ÇOĞALTILMAMAK VE KOPYA EDİLMEKEMEK ŞARTI İLE İZİN VERİLMİŞTİR.	PVC ENİ : MDF MİKTARI : PLAKADAN ÇIKAN :	KSM ÖLÇÜCÜ :	KUTU İÇİ : KUTU İÇİ ADET :
ARGE SORUMLUSU DOĞUKAN DEMİR	THIS DRAWING PROFILE - SİLAS FOREST PRODUCTS WHAT TO DO. UNLOCKED AND COPY NOT ALLOWED WITH THE WRITTEN.	GENEL TOLERANS : PROFL BOY TOLERANSI :	MATERİYAL MM MDF	TARİH / DATE 12.11.2018

12 mm Profiles

PROFİLSE - SİLAS ORMAN ÜRÜNLERİ

KAĞIT ÜZERİNDEN ÖLÇÜ ALMAYINIZ !!!
Don't measure on paper.

ÜRÜN KODU 12*72
(Product Code)

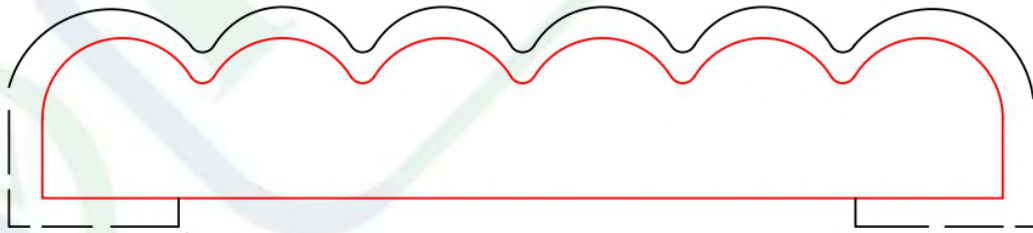
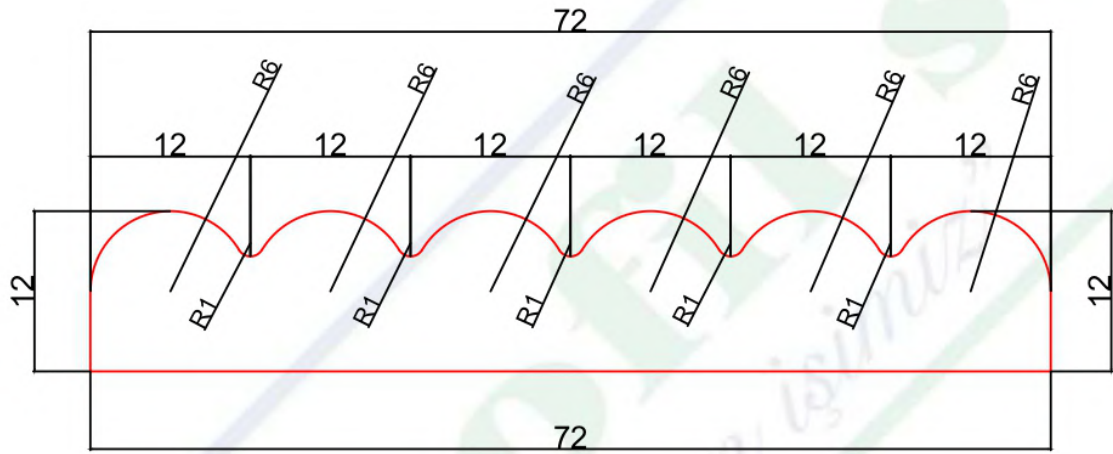

PVC BİTİŞ YERİ

(Pvc ending area)

BÖLÜM SORUMLUSU NEJDET ALTINTOPRAK	BU ÇİZİM PROFİLSE - SİLAS ORMAN ÜRÜNLERİ'NE AİTTİR. İZİNSİZ ÇOĞALTILMAMAK VE KOPYA EDİLMEMEK ŞARTI İLE İZİN VERİLMİŞTİR.	PVC ENİ : MDF MİKTARI : PLAKADAN ÇIKAN :	KSM ÖLÇÜCÜ :	KUTU İÇİ : KUTU İÇİ ADET :
ARGE SORUMLUSU DOĞUKAN DEMİR	THIS DRAWING PROFILE - SİLAS FOREST PRODUCTS WHAT TO DO. UNLOCKED AND COPY NOT ALLOWED WITH THE WRITTEN.	GENEL TOLERANS : PROFİL BOY TOLERANSI :	MATERİYAL MM MDF	TARİH / DATE 30.01.2019

12 mm Profiles

PROFİLSE - SİLAS ORMAN ÜRÜNLERİ

KAGIT ÜZERİNDEN ÖLÇÜ ALMAYINIZ !!!

Don't measurate on paper.

ÜRÜN KODU : 12*22

(Product Code)

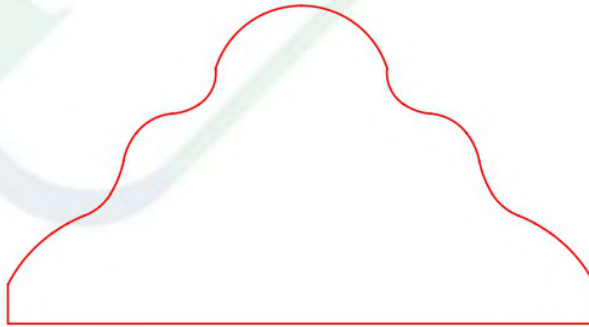
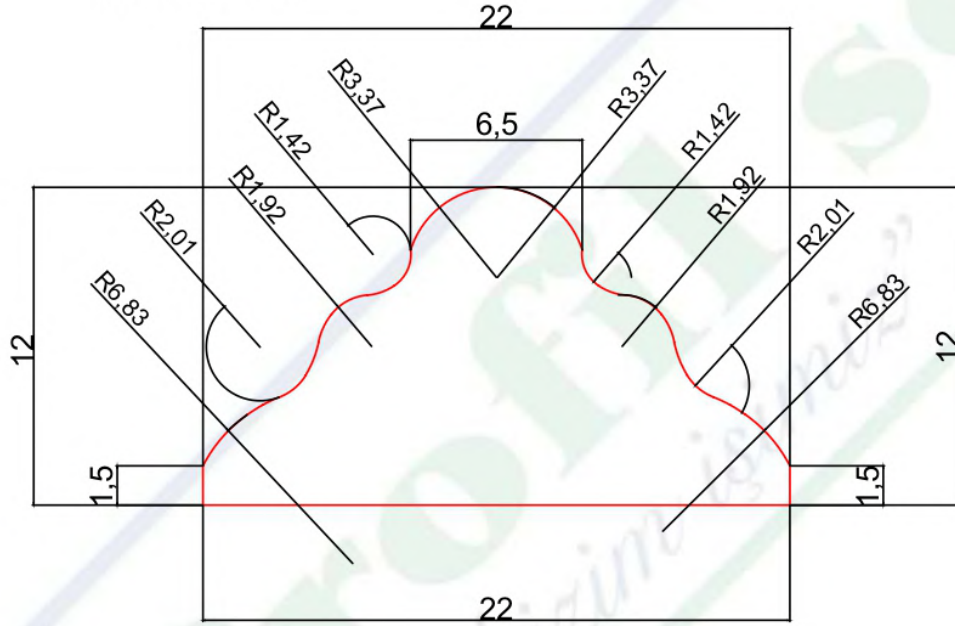

BÖLÜM SORUMLUSU NEJDET ALTINTOPRAK	BU ÇİZİM PROFİLSE - SİLAS ORMAN ÜRÜNLERİ'NE AİTTİR. İZİNSİZ ÇOĞALTILMAMAK VE KOPYA EDİLMEMEK ŞARTI İLE İZİN VERİLMİŞTİR.	PVC ENİ : MDF MİKTARI : PLAKADAN ÇIKAN :	KSM ÖLÇÜCÜ :	KUTU İÇİ : KUTU İÇİ ADET :
ARGE SORUMLUSU DOĞUKAN DEMİR	THIS DRAWING PROFILE - SİLAS FOREST PRODUCTS WHAT TO DO. UNLOCKED AND COPY NOT ALLOWED WITH THE WRITTEN.	GENEL TOLERANS : PROFİL BOY TOLERANSI :	MATERIAL MM MDF	TARİH / DATE 28.03.2019

12 mm Profiles

PROFİLSE - SİLAS ORMAN ÜRÜNLERİ

KAĞIT ÜZERİNDEN ÖLÇÜ ALMAYINIZ !!!
Don't measure on paper.

ÜRÜN KODU : 12*60
(Product Code)

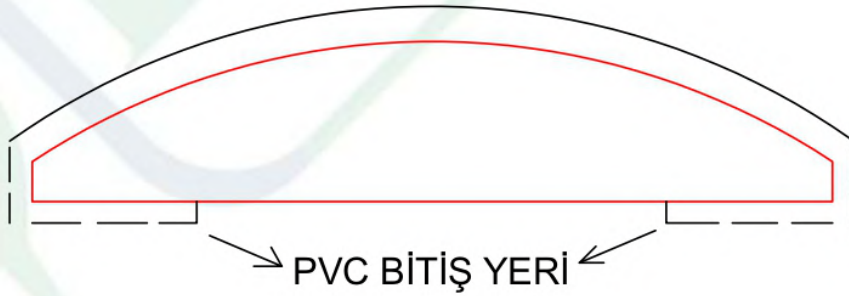
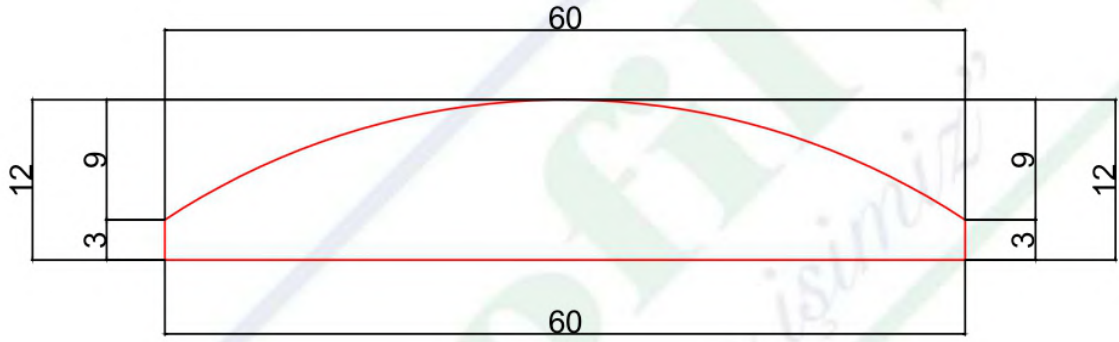

(Pvc ending area)

BÖLÜM SORUMLUSU NEJDET ALTINTOPRAK	BU ÇİZİM PROFİLSE - SİLAS ORMAN ÜRÜNLERİ'NE AİTTİR. İZİNSİZ ÇOĞALTILMAMAK VE KOPYA EDİLMEMEK ŞARTI İLE İZİN VERİLMİŞTİR.	PVC ENİ : MDF MİKTARI : PLAKADAN ÇIKAN :	KSM ÖLÇÜCÜ :	KUTU İÇİ : KUTU İÇİ ADET :
ARGE SORUMLUSU DOĞUKAN DEMİR	THIS DRAWING PROFILE - SİLAS FOREST PRODUCTS WHAT TO DO. UNLOCKED AND COPY NOT ALLOWED WITH THE WRITTEN.	GENEL TOLERANS : PROFL BOY TOLERANSI :	MATERİYAL MM MDF	TARİH / DATE 08.03.2019

12 mm Profiles

PROFİLSE - SİLAS ORMAN ÜRÜNLERİ

KAĞIT ÜZERİNDEN ÖLÇÜ ALMAYINIZ !!!
Don't measure on paper.

ÜRÜN KODU : 12*18

(Product Code)

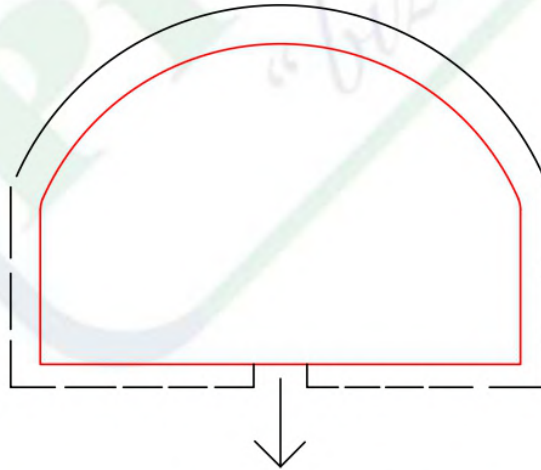
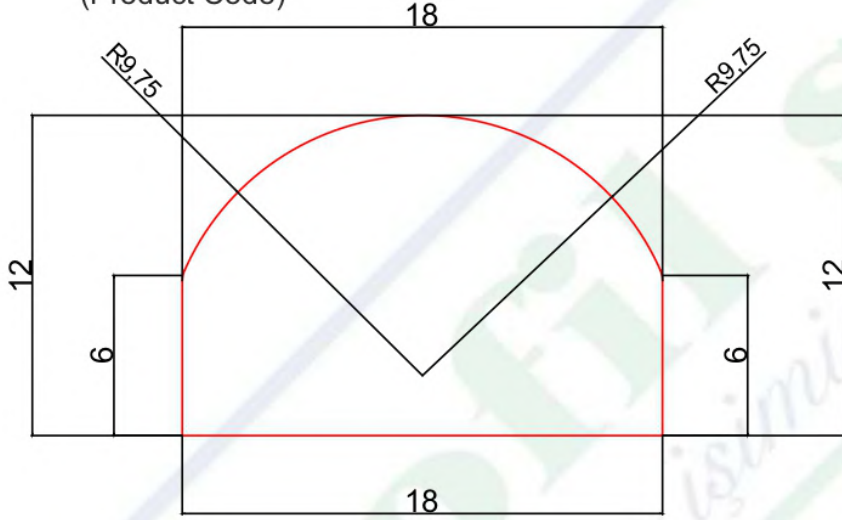

PVC BİTİŞ YERİ
(Pvc ending area)

BÖLÜM SORUMLUSU NEJDET ALTINTOPRAK	BU ÇİZİM PROFİLSE - SİLAS ORMAN ÜRÜNLERİ'NE AİTTİR. İZINSİZ ÇOĞALTILMAMAK VE KOPYA EDİLMEMEK ŞARTI İLE İZİN VERİLMİŞTİR.	PVC ENİ : MDF MİKTARI : PLAKADAN ÇIKAN :	KSM ÖLÇÜCÜ :	KUTU İÇİ : KUTU İÇİ ADET :
ARGE SORUMLUSU DOĞUKAN DEMİR	THIS DRAWING PROFILE - SİLAS FOREST PRODUCTS WHAT TO DO. UNLOCKED AND COPY NOT ALLOWED WITH THE WRITTEN.	GENEL TOLERANS : PROFİL BOY TOLERANSI :	MATERİYAL MM MDF	TARİH / DATE 01.03.2019

12 mm Profiles

PROFİLSE - SİLAS ORMAN ÜRÜNLERİ

KAĞIT ÜZERİNDEN ÖLÇÜ ALMAYINIZ !!!

Don't measurate on paper.

ÜRÜN KODU : 12*20

(Product Code)

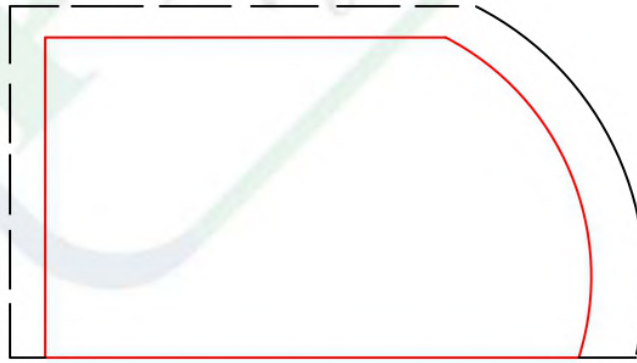
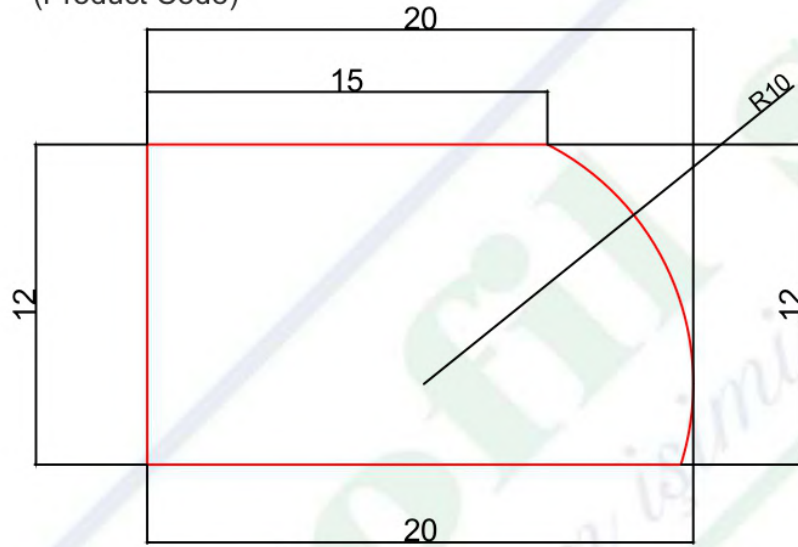

→ PVC BİTİŞ YERİ
(Pvc ending area) ←

BÖLÜM SORUMLUSU NEJDET ALTINTOPRAK	BU ÇİZİM PROFİLSE - SİLAS ORMAN ÜRÜNLERİ'NE AİTTİR. İZINSİZ ÇOĞALTILMAMAK VE KOPYA EDİLMEMEK ŞARTI İLE İZİN VERİLMİŞTİR.	PVC ENİ : MDF MİKTARI : PLAKADAN ÇIKAN :	KSM ÖLÇÜCÜ :	KUTU İÇİ : KUTU İÇİ ADET :
ARGE SORUMLUSU DOĞUKAN DEMİR	THIS DRAWING PROFILE - SİLAS FOREST PRODUCTS WHAT TO DO. UNLOCKED AND COPY NOT ALLOWED WITH THE WRITTEN.	GENEL TOLERANS : PROFL BOY TOLERANSI :	MATERİYAL MM MDF	TARİH / DATE 01.03.2019

12 mm Profiles

PROFİLSE - SİLAS ORMAN ÜRÜNLERİ

KAĞIT ÜZERİNDEN ÖLÇÜ ALMAYINIZ !!!
Don't measure on paper.

ÜRÜN KODU : 12*30
(Product Code)

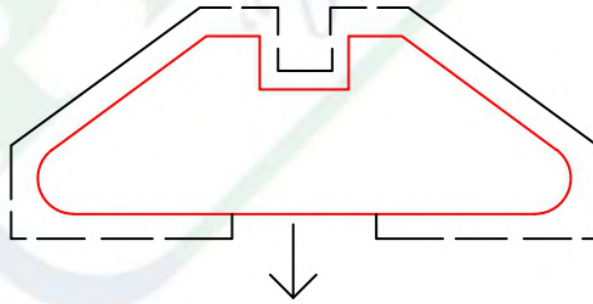
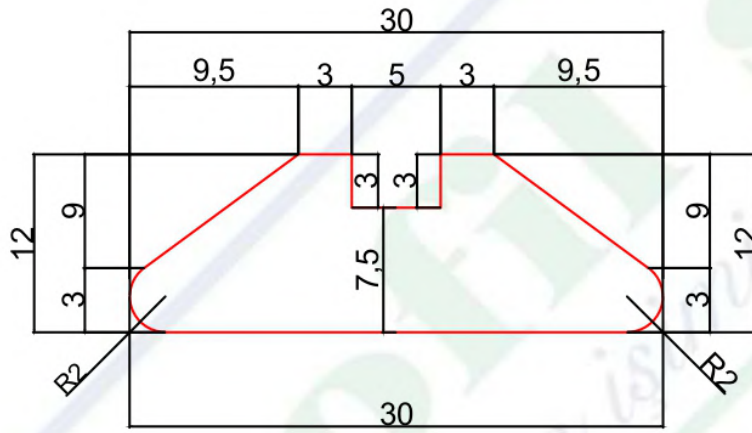

PVC BİTİŞ YERİ

(Pvc ending area)

BÖLÜM SORUMLUSU NEJDET ALTINTOPRAK	BU ÇİZİM PROFİLSE - SİLAS ORMAN ÜRÜNLERİ'NE AİTTİR. İZİNSİZ ÇOĞALTILMAMAK VE KOPYA EDİLMEMEK ŞARTI İLE İZİN VERİLMİŞTİR.	PVC ENİ : MDF MİKTARI : PLAKADAN ÇIKAN :	KSM ÖLÇÜCÜ :	KUTU İÇİ : KUTU İÇİ ADET :
ARGE SORUMLUSU DOĞUKAN DEMİR	THIS DRAWING PROFILE - SİLAS FOREST PRODUCTS WHAT TO DO. UNLOCKED AND COPY NOT ALLOWED WITH THE WRITTEN.	GENEL TOLERANS : PROFL BOY TOLERANSI :	MATERIAL MM MDF	TARİH / DATE 03.04.2019

12 mm Profiles

PROFİLSE - SİLAS ORMAN ÜRÜNLERİ

KAĞIT ÜZERİNDEN ÖLÇÜ ALMAYINIZ !!!
Don't measure on paper.

ÜRÜN KODU : 12*50

(Product Code)

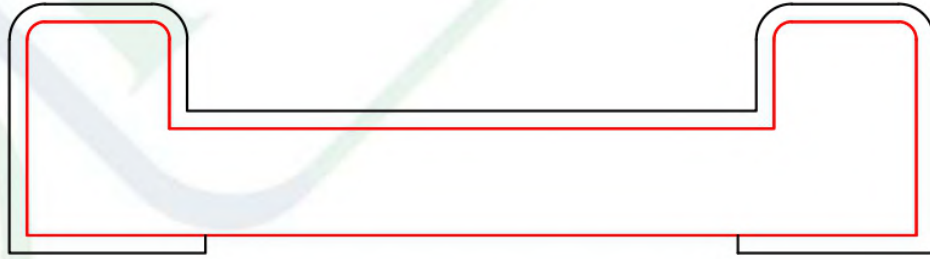
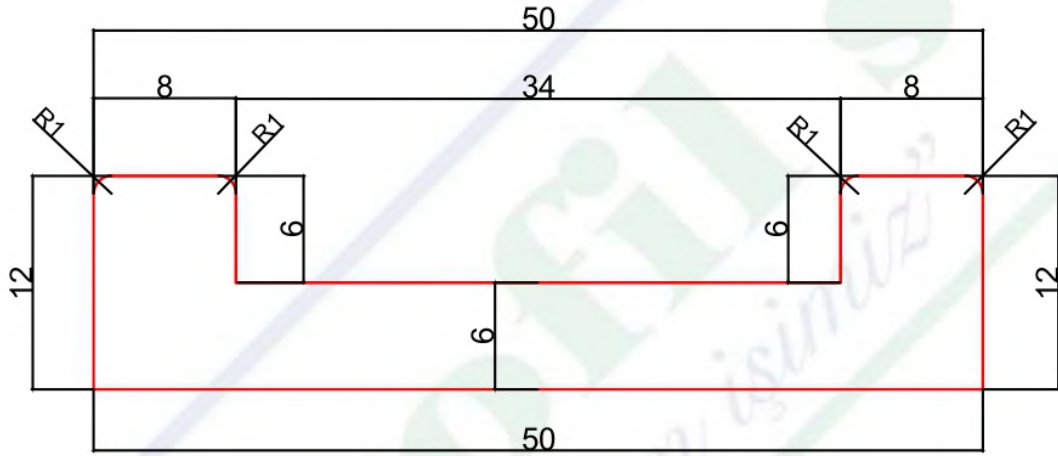

PVC BİTİŞ YERİ

(Pvc ending area)

BÖLÜM SORUMLUSU NEJDET ALTINTOPRAK	BU ÇİZİM PROFİLSE - SİLAS ORMAN ÜRÜNLERİ'NE AİTTİR. İZINSİZ ÇOĞALTILMAMAK VE KOPYA EDİLMEMEK ŞARTI İLE İZİN VERİLMİŞTİR.	MDF MİKTARI : TABAKADAN ÇIKAN :	PVC ÖLÇÜSÜ :	KUTU İÇİ : KUTU İÇİ ADET :
ARGE SORUMLUSU DOĞUKAN DEMİR	THIS DRAWING PROFILE - SİLAS FOREST PRODUCTS WHAT TO DO. UNLOCKED AND COPY NOT ALLOWED WITH THE WRITTEN.	STANDART PROFİL BOY : PROFİL BOY :	MDF TÜRÜ : MM MDF	TARİH / DATE 18.04.2019

12 mm Profiles

PROFİLSE - SİLAS ORMAN ÜRÜNLERİ

KAĞIT ÜZERİNDEN ÖLÇÜ ALMAYINIZ !!!
Don't measurate on paper.

ÜRÜN KODU : 12*16

(Product Code)

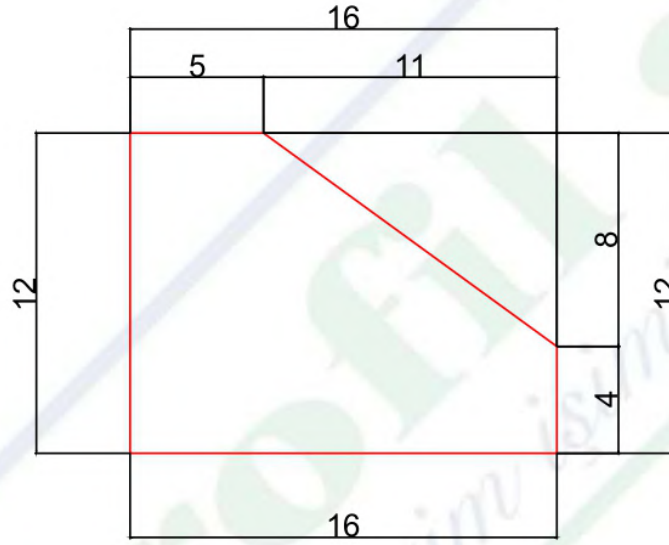

PVC BİTİŞ YERİ
(Pvc ending area)

BÖLÜM SORUMLUSU NEJDET ALTINTOPRAK	BU ÇİZİM PROFİLSE - SİLAS ORMAN ÜRÜNLERİ'NE AİTTİR. İZINSİZ ÇOĞALTILMAMAK VE KOPYA EDİLMEKEMEK ŞARTI İLE İZİN VERİLMİŞTİR.	PVC ENİ : MDF MİKTARI : PLAKADAN ÇIKAN :	KSM ÖLÇÜCÜ :	KUTU İÇİ : KUTU İÇİ ADET :
ARGE SORUMLUSU DOĞUKAN DEMİR	THIS DRAWING PROFILE - SİLAS FOREST PRODUCTS WHAT TO DO. UNLOCKED AND COPY NOT ALLOWED WITH THE WRITTEN.	GENEL TOLERANS : PROFİL BOY TOLERANSI :	MATERİAL MM MDF	TARİH / DATE 11.04.2019

12 mm Profiles

PROFİLSE - SİLAS ORMAN ÜRÜNLERİ

KAĞIT ÜZERİNDEN ÖLÇÜ ALMAYINIZ !!!
Don't measurate on paper.

ÜRÜN KODU : 12*28
(Product Code)

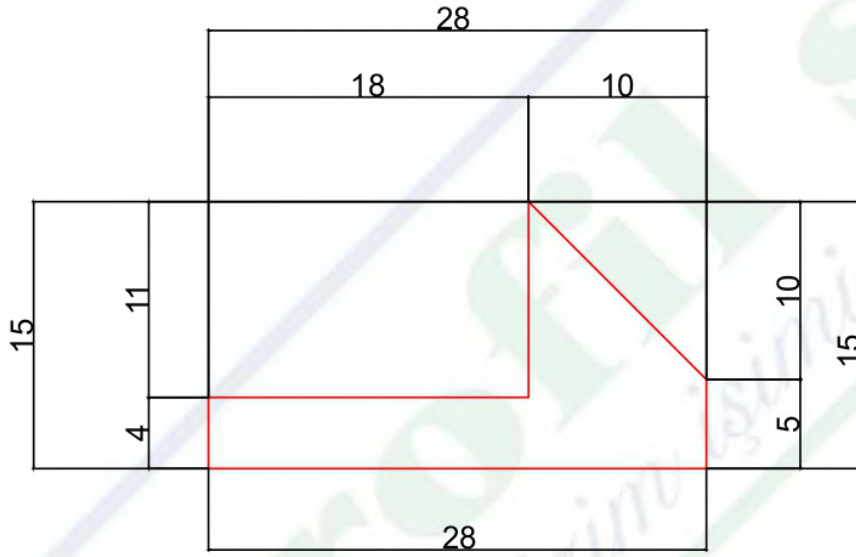

(Pvc ending area)
PVC BİTİŞ YERİ

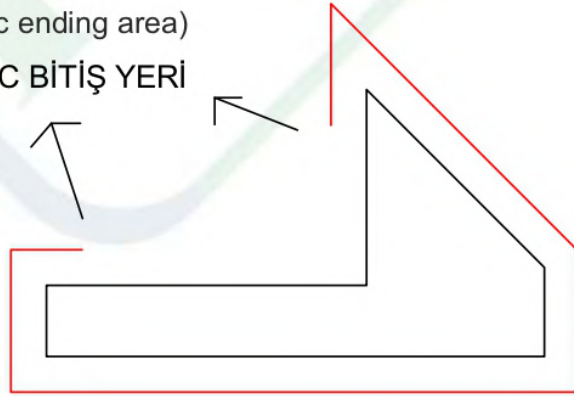

BÖLÜM SORUMLUSU NEJDET ALTINTOPRAK	BU ÇİZİM PROFİLSE - SİLAS ORMAN ÜRÜNLERİ'NE AİTTİR. İZINSİZ ÇOĞALTILMAMAK VE KOPYA EDİLMEKEMEK ŞARTI İLE İZİN VERİLMİŞTİR.	PVC ENİ : MDF MIKTARI : PLAKADAN ÇIKAN :	KSM ÖLÇÜCÜ :	KUTU İÇİ : KUTU İÇİ ADET :
ARGE SORUMLUSU DOĞUKAN DEMİR	THIS DRAWING PROFILE - SİLAS FOREST PRODUCTS WHAT TO DO. UNLOCKED AND COPY NOT ALLOWED WITH THE WRITTEN.	GENEL TOLERANS : PROFİL BOY TOLERANSI :	MATERİYAL : MM MDF	TARİH / DATE 19.02.2019

12 mm Profiles

PROFİLSE - SİLAS ORMAN ÜRÜNLERİ

KAĞIT ÜZERİNDEN ÖLÇÜ ALMAYINIZ !!!

Don't measurate on paper.

ÜRÜN KODU : 12*50
(Product Code)

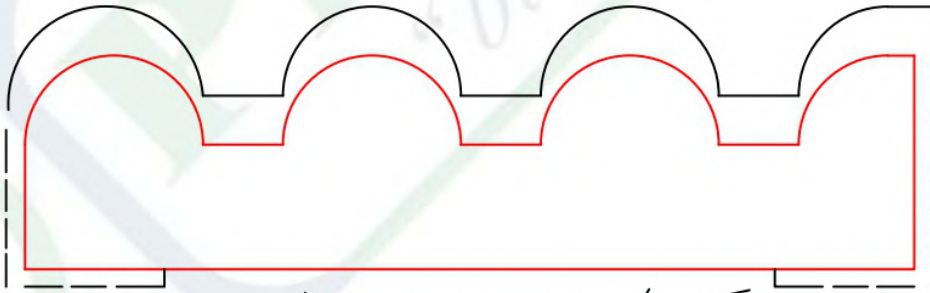
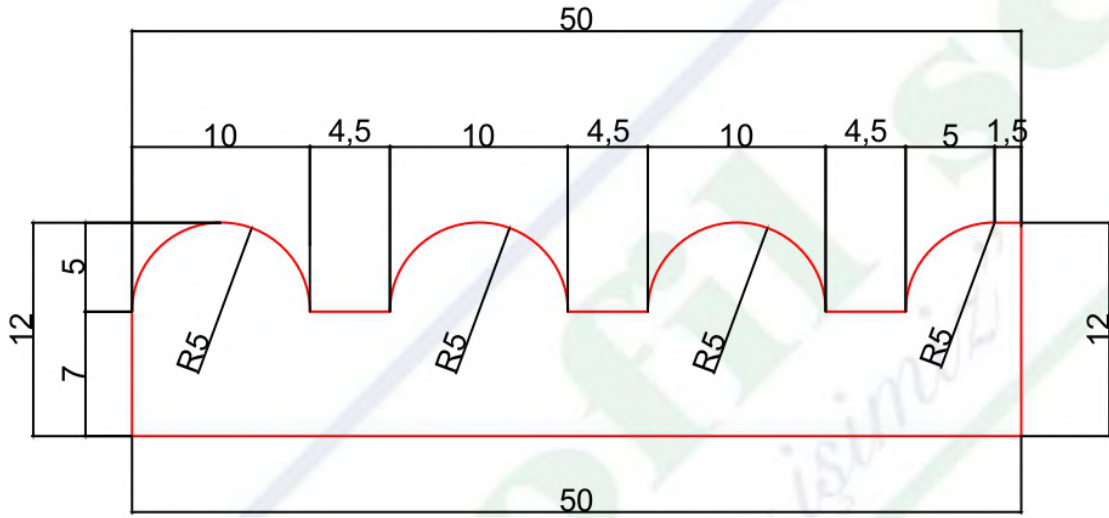

PVC BİTİŞ YERİ

(Pvc ending area)

BÖLÜM SORUMLUSU NEJDET ALTINTOPRAK	BU ÇİZİM PROFİLSE - SİLAS ORMAN ÜRÜNLERİ'NE AİTTİR. İZİNSİZ ÇOĞALTILMAMAK VE KOPYA EDİLMEMEK ŞARTI İLE İZİN VERİLMİŞTİR.	PVC ENİ : MDF MİKTARI : PLAKADAN ÇIKAN :	KSM ÖLÇÜCÜ :	KUTU İÇİ : KUTU İÇİ ADET :
ARGE SORUMLUSU DOĞUKAN DEMİR	THIS DRAWING PROFILE - SİLAS FOREST PRODUCTS WHAT TO DO. UNLOCKED AND COPY NOT ALLOWED WITH THE WRITTEN.	GENEL TOLERANS : PROFL BOY TOLERANSI :	MATERİAL MM MDF	TARİH / DATE 17.01.2019

12 mm Profiles

PROFİLSE - SİLAS ORMAN ÜRÜNLERİ

KAĞIT ÜZERİNDEN ÖLÇÜ ALMAYINIZ !!!
Don't measure on paper.

ÜRÜN KODU : 12*60
(Product Code)

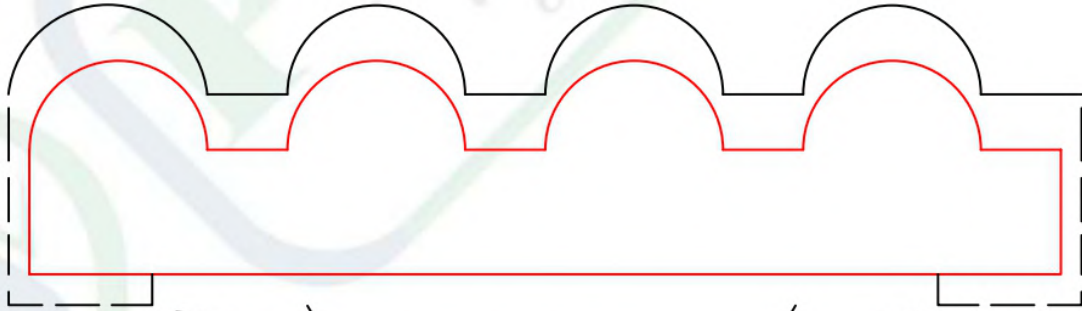
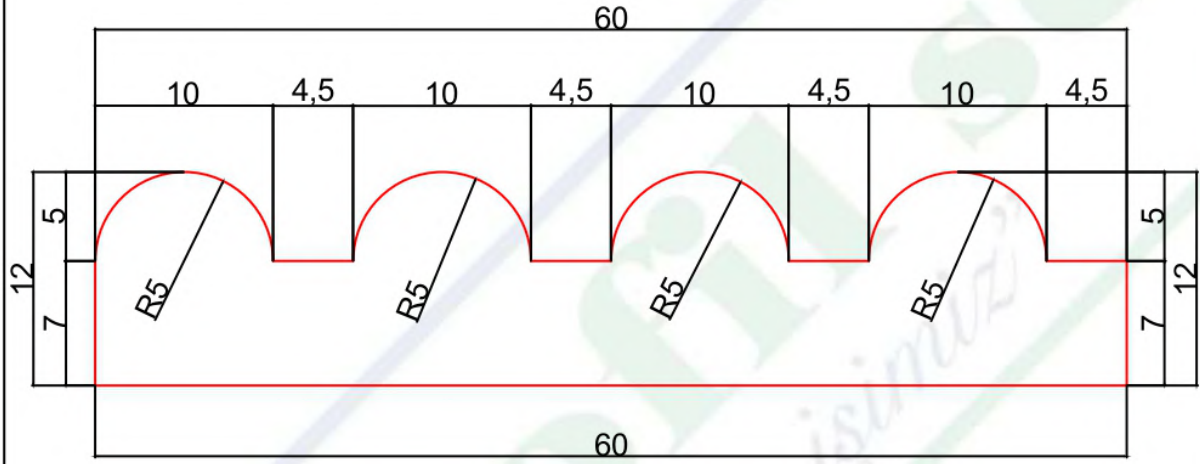

PVC BİTİŞ YERİ

(Pvc ending area)

BÖLÜM SORUMLUSU NEJDET ALTINTOPRAK	BU ÇİZİM PROFİLSE - SİLAS ORMAN ÜRÜNLERİ'NE AİTTİR. İZİNSİZ ÇOĞALTILMAMAK VE KOPYA EDİLMEMEK ŞARTI İLE İZİN VERİLMİŞTİR.	PVC ENİ : MDF MİKTARI : PLAKADAN ÇIKAN :	KSM ÖLÇÜCÜ :	KUTU İÇİ : KUTU İÇİ ADET :
ARGE SORUMLUSU DOĞUKAN DEMİR	THIS DRAWING PROFILE - SİLAS FOREST PRODUCTS WHAT TO DO. UNLOCKED AND COPY NOT ALLOWED WITH THE WRITTEN.	GENEL TOLERANS : PROFL BOY TOLERANSI :	MATERİYAL : MM MDF	TARİH / DATE 17.01.2019

12 mm Profiles

PROFİLSE - SİLAS ORMAN ÜRÜNLERİ

KAĞIT ÜZERİNDEN ÖLÇÜ ALMAYINIZ !!!
Don't measure on paper.

ÜRÜN KODU : 12*110
(Product Code)

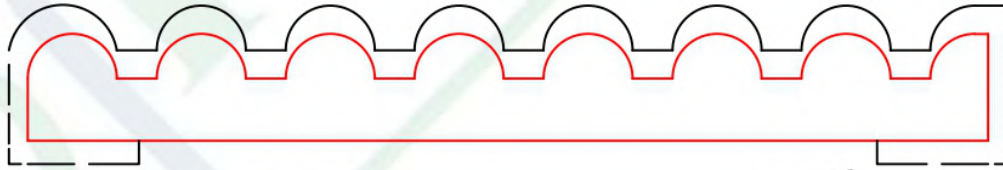
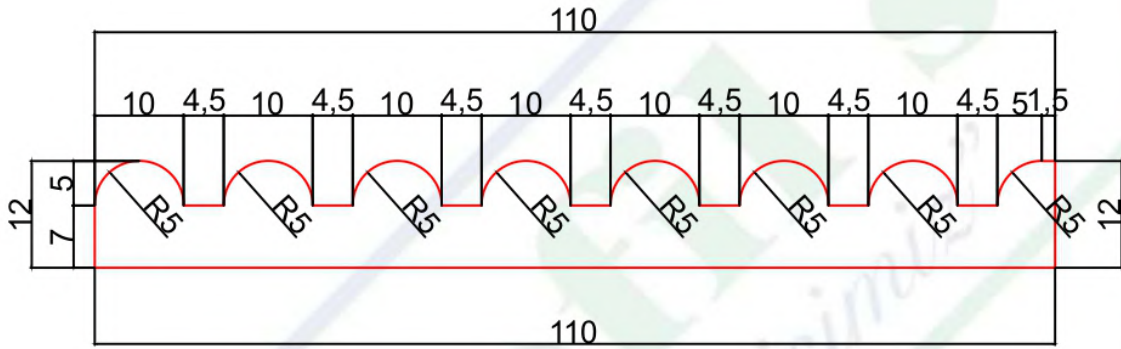

PVC BİTİŞ YERİ
(Pvc ending area)

BÖLÜM SORUMLUSU NEJDET ALTINTOPRAK	BU ÇİZİM PROFİLSE - SİLAS ORMAN ÜRÜNLERİ'NE AİTTİR. İZINSİZ ÇOĞALTILMAMAK VE KOPYA EDİLMEMEK ŞARTI İLE İZİN VERİLMİŞTİR.	PVC ENİ : MDF MİKTARI : PLAKADAN ÇIKAN :	KSM ÖLÇÜCÜ :	KUTU İÇİ : KUTU İÇİ ADET :
ARGE SORUMLUSU DOĞUKAN DEMİR	THIS DRAWING PROFILE - SİLAS FOREST PRODUCTS WHAT TO DO. UNLOCKED AND COPY NOT ALLOWED WITH THE WRITTEN.	GENEL TOLERANS : PROFİL BOY TOLERANSI :	MATERİYAL MM MDF	TARİH / DATE 17.01.2019

12 mm Profiles

PROFİLSE - SİLAS ORMAN ÜRÜNLERİ

KAĞIT ÜZERİNDEN ÖLÇÜ ALMAYINIZ !!!
Don't measurate on paper.

ÜRÜN KODU : 12*30
(Product Code)

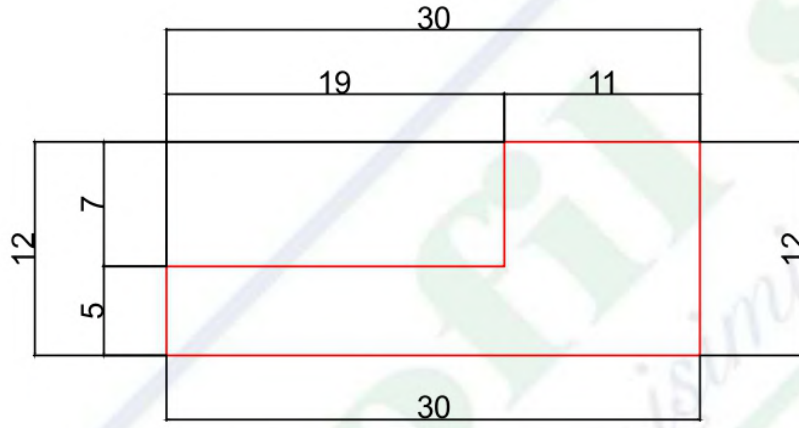

(Pvc ending area)
PVC BİTİŞ YERİ

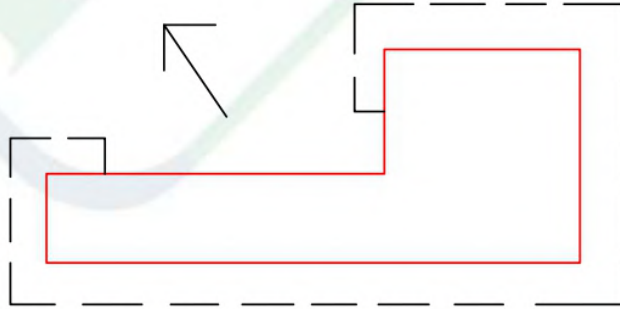

BÖLÜM SORUMLUSU NEJDET ALTINTOPRAK	BU ÇİZİM PROFİLSE - SİLAS ORMAN ÜRÜNLERİ'NE AİTTİR. İZINSİZ ÇOĞALTILMAMAK VE KOPYA EDİLMEMEK ŞARTI İLE İZİN VERİLMİŞTİR.	PVC ENİ : MDF MİKTARI : PLAKADAN ÇIKAN :	KSM ÖLÇÜCÜ :	KUTU İÇİ : KUTU İÇİ ADET :
ARGE SORUMLUSU DOĞUKAN DEMİR	THIS DRAWING PROFILE - SİLAS FOREST PRODUCTS WHAT TO DO. UNLOCKED AND COPY NOT ALLOWED WITH THE WRITTEN.	GENEL TOLERANS : PROFİL BOY TOLERANSI :	MATERİYAL MM MDF	TARİH / DATE 04.10.2018

12 mm Profiles

PROFİLSE - SİLAS ORMAN ÜRÜNLERİ

KAĞIT ÜZERİNDEN ÖLÇÜ ALMAYINIZ !!!
Don't measure on paper.

ÜRÜN KODU : 12*18
(Product Code)

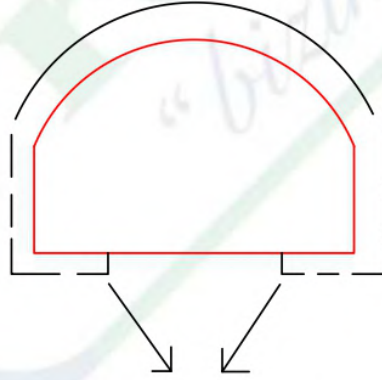
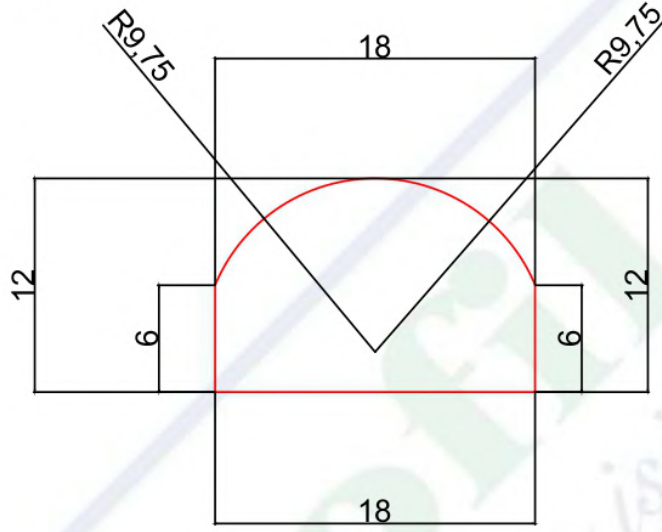

PVC BİTİŞ YERİ
(Pvc ending area)

BÖLÜM SORUMLUSU NEJDET ALTINTOPRAK	BU ÇİZİM PROFİLSE - SİLAS ORMAN ÜRÜNLERİ'NE AİTTİR. İZİNSİZ ÇOĞALTILMAMAK VE KOPYA EDİLMEKEMEK ŞARTI İLE İZİN VERİLMİŞTİR.	PVC ENİ : MDF MİKTARI : PLAKADAN ÇIKAN :	KSM ÖLÇÜCÜ :	KUTU İÇİ : KUTU İÇİ ADET :
ARGE SORUMLUSU DOĞUKAN DEMİR	THIS DRAWING PROFILE - SILAS FOREST PRODUCTS WHAT TO DO. UNLOCKED AND COPY NOT ALLOWED WITH THE WRITTEN.	GENEL TOLERANS : PROFİL BOY TOLERANSI :	MATERİYAL MM MDF	TARİH / DATE 19.11.2018

12 mm Profiles

PROFİLSE - SİLAS ORMAN ÜRÜNLERİ

KAĞIT ÜZERİNDEN ÖLÇÜ ALMAYINIZ !!!
Don't measure on paper.

ÜRÜN KODU : 12*25
(Product Code)

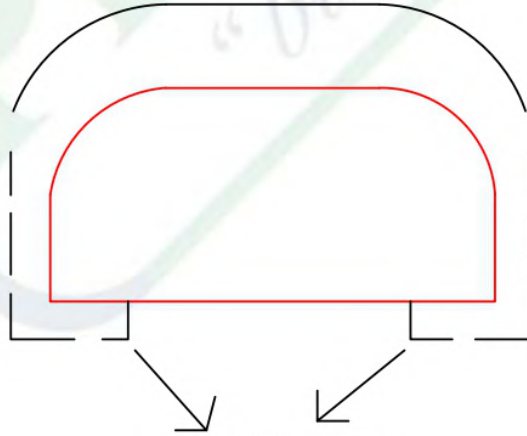
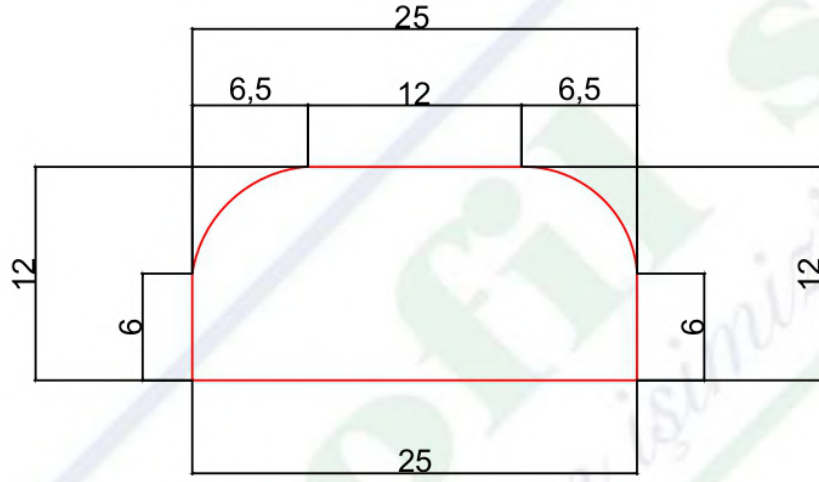

PVC BİTİŞ YERİ
(Pvc ending area)

BÖLÜM SORUMLUSU NEJDET ALTINTOPRAK	BU ÇİZİM PROFİLSE - SİLAS ORMAN ÜRÜNLERİ'NE AİTTİR. İZINSİZ ÇOĞALTILMAMAK VE KOPYA EDİLMEMEK ŞARTI İLE İZİN VERİLMİŞTİR.	PVC ENİ : MDF MİKTARI : PLAKADAN ÇIKAN :	KSM ÖLÇÜCÜ :	KUTU İÇİ : KUTU İÇİ ADET :
ARGE SORUMLUSU DOĞUKAN DEMİR	THIS DRAWING PROFILE - SİLAS FOREST PRODUCTS WHAT TO DO. UNLOCKED AND COPY NOT ALLOWED WITH THE WRITTEN.	GENEL TOLERANS : PROFİL BOY TOLERANSI :	MATERİYAL MM MDF	TARİH / DATE 19.11.2018

12 mm Profiles

PROFİLSE - SİLAS ORMAN ÜRÜNLERİ

KAĞIT ÜZERİNDEN ÖLÇÜ ALMAYINIZ !!!
Don't measure on paper.

ÜRÜN KODU : 12*160
(Product Code)

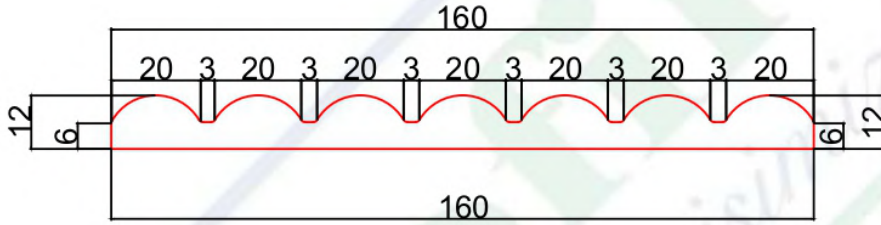

PVC BİTİŞ YERİ
(Pvc ending area)

BÖLÜM SORUMLUSU NEJDET ALTINTOPRAK	BU ÇİZİM PROFİLSE - SİLAS ORMAN ÜRÜNLERİ'NE AİTTİR. İZINSİZ ÇOĞALTILMAMAK VE KOPYA EDİLMEMEK ŞARTI İLE İZİN VERİLMİŞTİR.	PVC ENİ : MDF MİKTARI : PLAKADAN ÇIKAN :	KSM ÖLÇÜCÜ :	KUTU İÇİ : KUTU İÇİ ADET :
ARGE SORUMLUSU DOĞUKAN DEMİR	THIS DRAWING PROFILE - SİLAS FOREST PRODUCTS WHAT TO DO. UNLOCKED AND COPY NOT ALLOWED WITH THE WRITTEN.	GENEL TOLERANS : PROFİL BOY TOLERANSI :	MATERİYAL MM MDF	TARİH / DATE 19.11.2018

12 mm Profiles

PROFİLSE - SİLAS ORMAN ÜRÜNLERİ

KAĞIT ÜZERİNDEN ÖLÇÜ ALMAYINIZ !!!
Don't measure on paper.

ÜRÜN KODU : 12*30
(Product Code)

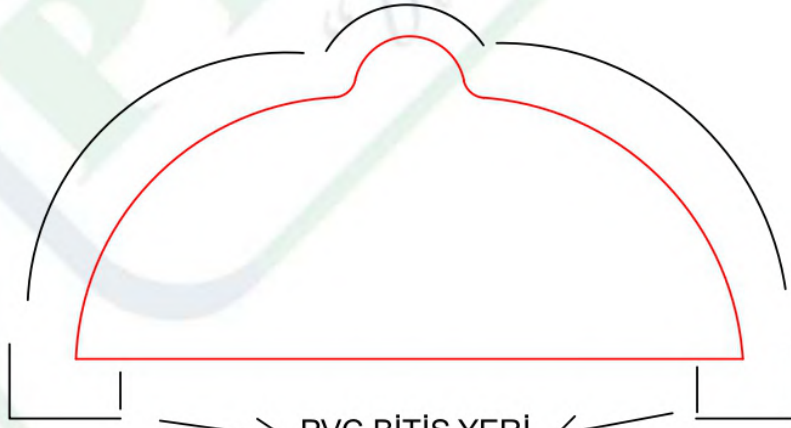
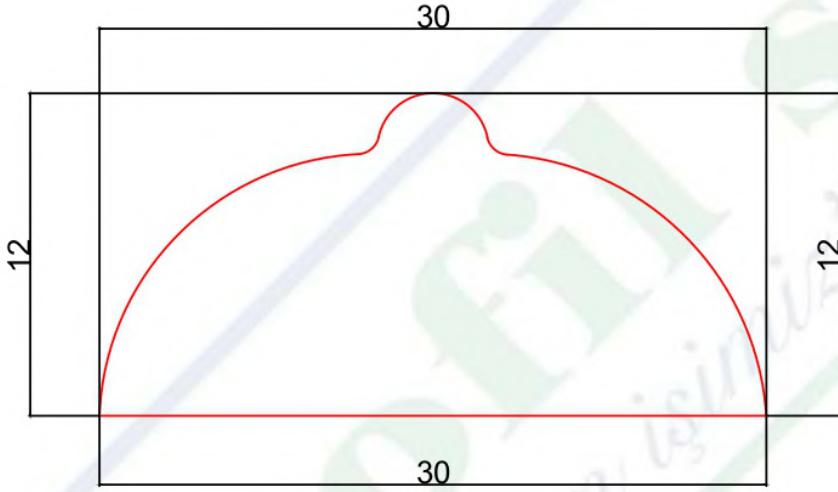

(Pvc ending area)

BÖLÜM SORUMLUSU NEJDET ALTINTOPRAK	BU ÇİZİM PROFİLSE - SİLAS ORMAN ÜRÜNLERİ'NE AİTTİR. İZİNSİZ ÇOĞALTILMAMAK VE KOPYA EDİLMEMEK ŞARTI İLE İZİN VERİLMİŞTİR.	PVC ENİ : MDF MİKTARI : PLAKADAN ÇIKAN :	KSM ÖLÇÜCÜ :	KUTU İÇİ : KUTU İÇİ ADET :
ARGE SORUMLUSU DOĞUKAN DEMİR	THIS DRAWING PROFILE - SİLAS FOREST PRODUCTS WHAT TO DO. UNLOCKED AND COPY NOT ALLOWED WITH THE WRITTEN.	GENEL TOLERANS : PROFİL BOY TOLERANSI :	MATERIAL MM MDF	TARİH / DATE 04.10.2018

12 mm Profiles

PROFİLSE - SİLAS ORMAN ÜRÜNLERİ

KAĞIT ÜZERİNDEN ÖLÇÜ ALMAYINIZ !!!
Don't measure on paper.

ÜRÜN KODU : 12*50-14
(Product Code)

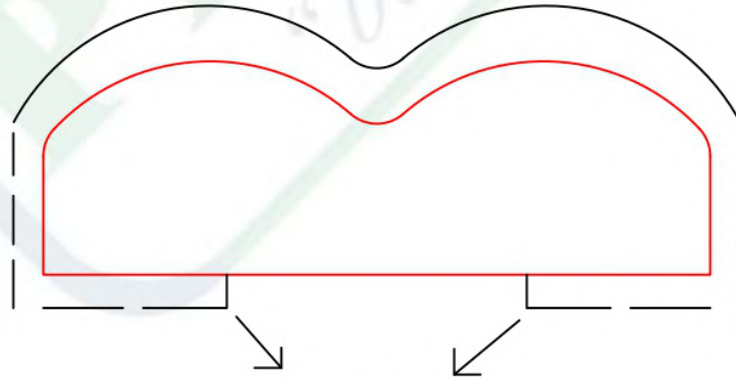
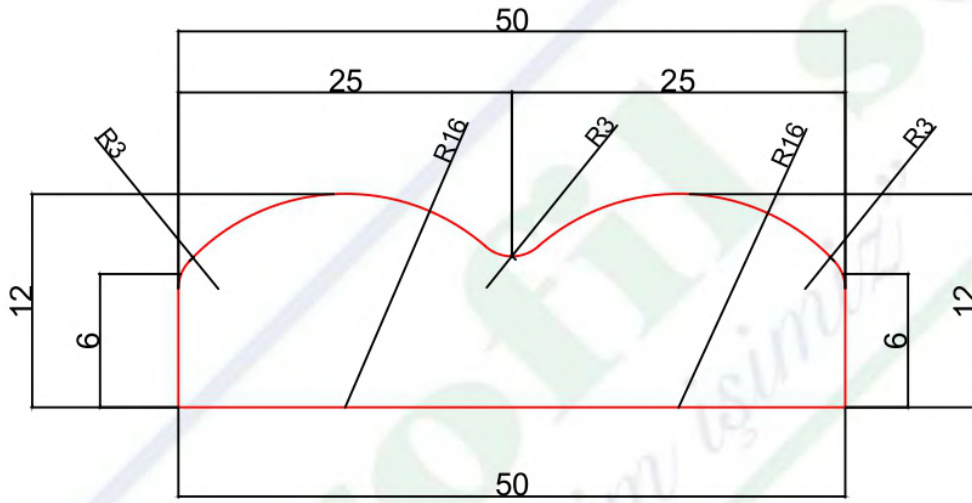

PVC BİTİŞ YERİ

(Pvc ending area)

BÖLÜM SORUMLUSU NEJDET ALTINTOPRAK	BU ÇİZİM PROFİLSE - SİLAS ORMAN ÜRÜNLERİ'NE AİTTİR. İZINSİZ ÇOĞALTILMAMAK VE KOPYA EDİLMEKEMK ŞARTI İLE İZİN VERİLMİŞTİR.	PVC ENİ : MDF MİKTARI : PLAKADAN ÇIKAN :	KSM ÖLÇÜCÜ :	KUTU İÇİ : KUTU İÇİ ADET :
ARGE SORUMLUSU DOĞUKAN DEMİR	THIS DRAWING PROFILE - SİLAS FOREST PRODUCTS WHAT TO DO. UNLOCKED AND COPY NOT ALLOWED WITH THE WRITTEN.	GENEL TOLERANS : PROFİL BOY TOLERANSI :	MATERİYAL MM MDF	TARİH / DATE 24.01.2019

12 mm Profiles

PROFİLSE - SİLAS ORMAN ÜRÜNLERİ

KAĞIT ÜZERİNDEN ÖLÇÜ ALMAYINIZ !!!
Don't measurate on paper.

ÜRÜN KODU : 12*30

(Product Code)

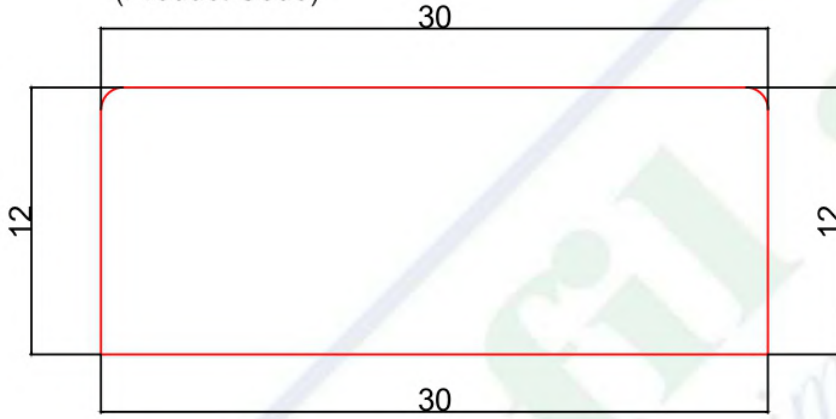

PVC BİTİŞ YERİ

(Pvc ending area)

BÖLÜM SORUMLUSU NEJDET ALTINTOPRAK	BU ÇİZİM PROFİLSE - SİLAS ORMAN ÜRÜNLERİ'NE AİTTİR. İZİNSİZ ÇOĞALTILMAMAK VE KOPYA EDİLMEMEK ŞARTI İLE İZİN VERİLMİŞTİR.	PVC ENİ : MDF MİKTARI : PLAKADAN ÇIKAN :	KSM ÖLÇÜCÜ :	KUTU İÇİ : KUTU İÇİ ADET :
ARGE SORUMLUSU DOĞUKAN DEMİR	THIS DRAWING PROFILE - SİLAS FOREST PRODUCTS WHAT TO DO. UNLOCKED AND COPY NOT ALLOWED WITH THE WRITTEN.	GENEL TOLERANS : PROFİL BOY TOLERANSI :	MATERİYAL MM MDF	TARİH / DATE 04.10.2018

12 mm Profiles

PROFİLSE - SİLAS ORMAN ÜRÜNLERİ

KAĞIT ÜZERİNDEN ÖLÇÜ ALMAYINIZ !!!
Don't measure on paper.

ÜRÜN KODU : 13*18
(Product Code)

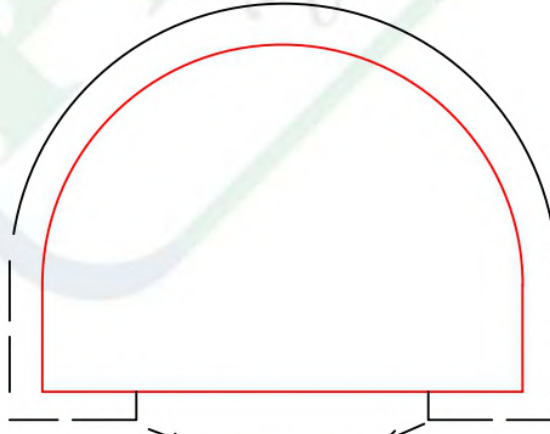
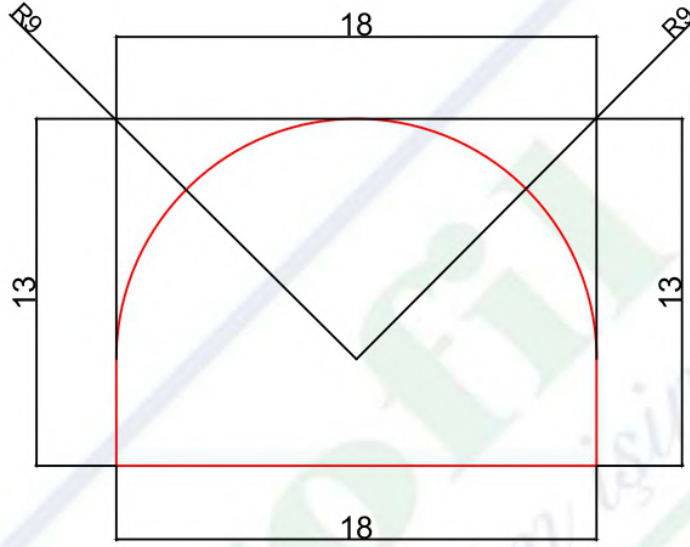

PVC BİTİŞ YERİ
(Pvc ending area)

BÖLÜM SORUMLUSU NEJDET ALTINTOPRAK	BU ÇİZİM PROFİLSE - SİLAS ORMAN ÜRÜNLERİ'NE AİTTİR. İZINSİZ ÇOĞALTILMAMAK VE KOPYA EDİLMEMEK ŞARTI İLE İZİN VERİLMİŞTİR.	PVC ENİ : MDF MİKTARI : PLAKADAN ÇIKAN :	KSM ÖLÇÜCÜ :	KUTU İÇİ : KUTU İÇİ ADET :
ARGE SORUMLUSU DOĞUKAN DEMİR	THIS DRAWING PROFILE - SİLAS FOREST PRODUCTS WHAT TO DO. UNLOCKED AND COPY NOT ALLOWED WITH THE WRITTEN.	GENEL TOLERANS : PROFİL BOY TOLERANSI :	MATERİYAL MM MDF	TARİH / DATE 24.01.2019

12 mm Profiles

PROFİLSE - SİLAS ORMAN ÜRÜNLERİ

KAĞIT ÜZERİNDEN ÖLÇÜ ALMAYINIZ !!!
Don't measure on paper.

ÜRÜN KODU : 12*50
(Product Code)

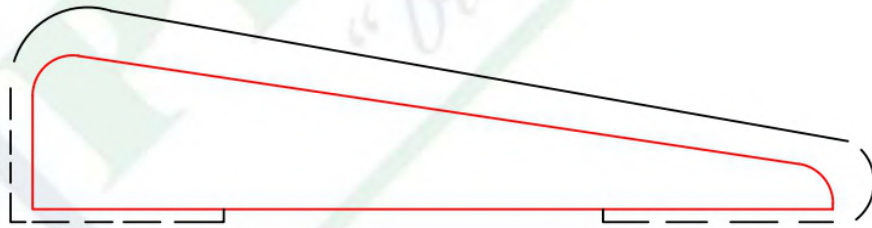
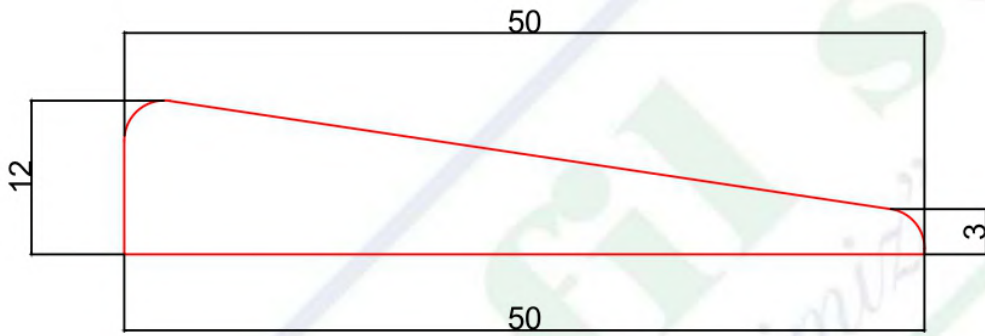

PVC BİTİŞ YERİ
(Pvc ending area)

BÖLÜM SORUMLUSU NEJDET ALTINTOPRAK	BU ÇİZİM PROFİLSE - SİLAS ORMAN ÜRÜNLERİ'NE AİTTİR. İZINSİZ ÇOĞALTILMAMAK VE KOPYA EDİLMEKEMEK ŞARTI İLE İZİN VERİLMİŞTİR.	PVC ENİ : MDF MİKTARI : PLAKADAN ÇIKAN :	KSM ÖLÇÜCÜ :	KUTU İÇİ : KUTU İÇİ ADET :
ARGE SORUMLUSU DOĞUKAN DEMİR	THIS DRAWING PROFILE - SİLAS FOREST PRODUCTS WHAT TO DO. UNLOCKED AND COPY NOT ALLOWED WITH THE WRITTEN.	GENEL TOLERANS : PROFİL BOY TOLERANSI :	MATERIAL MM MDF	TARİH / DATE 2.01.2019

12 mm Profiles

PROFİLSE - SİLAS ORMAN ÜRÜNLERİ

KAĞIT ÜZERİNDEN ÖLÇÜ ALMAYINIZ !!!

Don't measurate on paper.

ÜRÜN KODU : 12*14

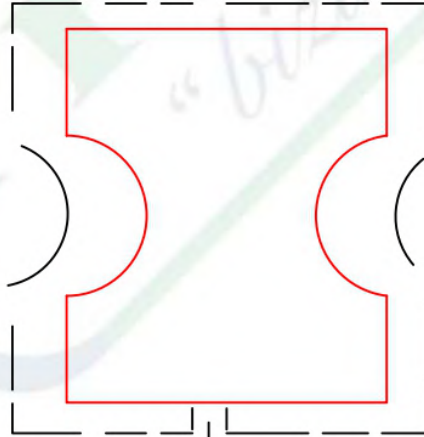
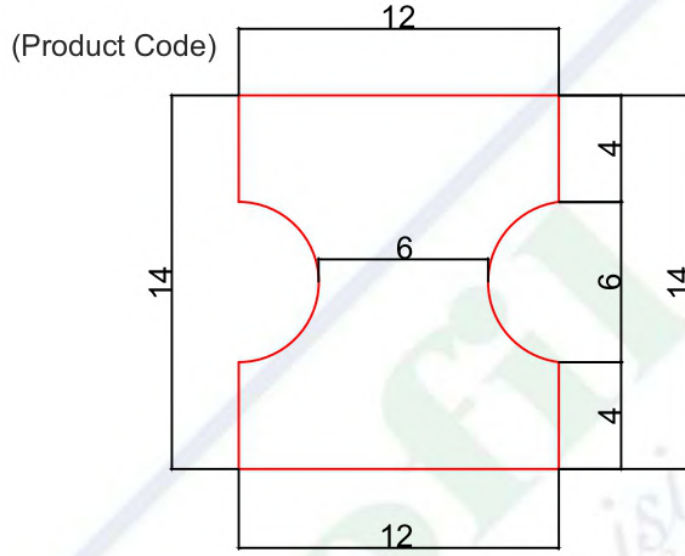

PVC BİTİŞ YERİ
(Pvc ending area)

BÖLÜM SORUMLUSU NEJDET ALTINTOPRAK	BU ÇİZİM PROFİLSE - SİLAS ORMAN ÜRÜNLERİ'NE AİTTİR. İZİNSİZ ÇOĞALTILMAMAK VE KOPYA EDİLMEMEK ŞARTI İLE İZİN VERİLMİŞTİR.	PVC ENİ : MDF MİKTARI : PLAKADAN ÇIKAN :	KSM ÖLÇÜCÜ :	KUTU İÇİ : KUTU İÇİ ADET :
ARGE SORUMLUSU DOĞUKAN DEMİR	THIS DRAWING PROFILE - SİLAS FOREST PRODUCTS WHAT TO DO. UNLOCKED AND COPY NOT ALLOWED WITH THE WRITTEN.	GENEL TOLERANS : PROFİL BOY TOLERANSI :	MATERIAL MM MDF	TARİH / DATE 04.10.2018

12 mm Profiles

PROFİLSE - SİLAS ORMAN ÜRÜNLERİ

KAĞIT ÜZERİNDEN ÖLÇÜ ALMAYINIZ !!!
Don't measure on paper.

ÜRÜN KODU : 12*205
(Product Code)

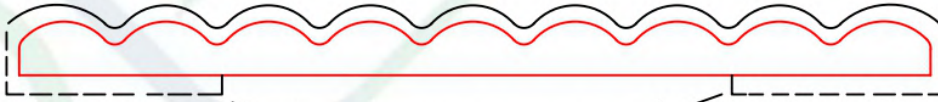
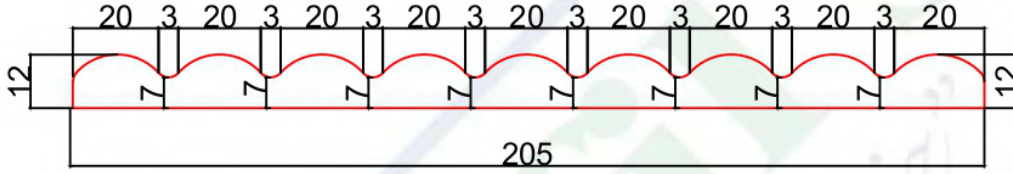

PVC BİTİŞ YERİ

(Pvc ending area)

BÖLÜM SORUMLUSU NEJDET ALTINTOPRAK	BU ÇİZİM PROFİLSE - SİLAS ORMAN ÜRÜNLERİ'NE AİTTİR. İZİNSİZ ÇOĞALTILMAMAK VE KOPYA EDİLMEK ŞARTI İLE İZİN VERİLMİŞTİR.	PVC ENİ : MDF MİKTARI : PLAKADAN ÇIKAN :	KSM ÖLÇÜCÜ :	KUTU İÇİ : KUTU İÇİ ADET :
ARGE SORUMLUSU DOĞUKAN DEMİR	THIS DRAWING PROFILE - SİLAS FOREST PRODUCTS WHAT TO DO. UNLOCKED AND COPY NOT ALLOWED WITH THE WRITTEN.	GENEL TOLERANS : PROFİL BOY TOLERANSI :	MATERIAL MM MDF	TARİH / DATE 12.11.2018

12 mm Profiles

PROFİLSE - SİLAS ORMAN ÜRÜNLERİ

KAĞIT ÜZERİNDEN ÖLÇÜ ALMAYINIZ !!!
Don't measure on paper.

ÜRÜN KODU : 12*20
(Product Code)

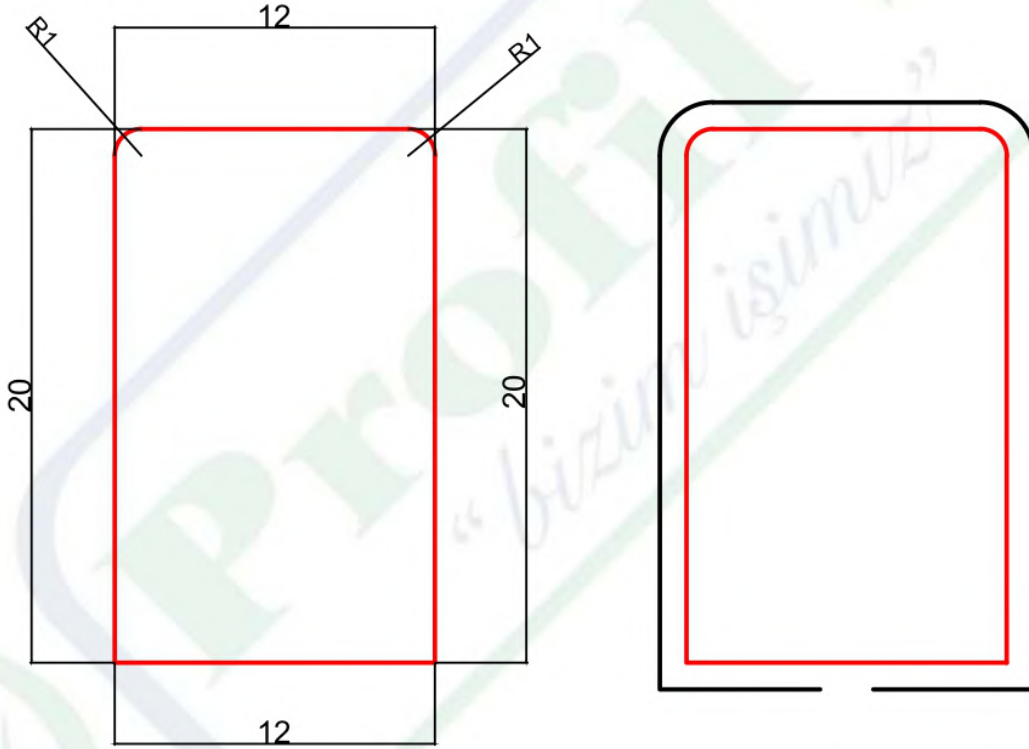

BÖLÜM SORUMLUSU NEJDET ALTINTOPRAK	BU ÇİZİM PROFİLSE - SİLAS ORMAN ÜRÜNLERİ'NE AİTTİR. İZINSİZ ÇOĞALTILMAMAK VE KOPYA EDİLMEK ŞARTI İLE İZİN VERİLMİŞTİR.	PVC ENİ : MDF MİKTARI : PLAKADAN ÇIKAN :	KSM ÖLÇÜCÜ :	KUTU İÇİ : KUTU İÇİ ADET :
ARGE SORUMLUSU DOĞUKAN DEMİR	THIS DRAWING PROFILE - SİLAS FOREST PRODUCTS WHAT TO DO. UNLOCKED AND COPY NOT ALLOWED WITH THE WRITTEN.	GENEL TOLERANS : PROFİL BOY TOLERANSI :	MATERIAL MM MDF	TARİH / DATE 3.01.2019

12 mm Profiles

PROFİLSE - SİLAS ORMAN ÜRÜNLERİ

KAĞIT ÜZERİNDEN ÖLÇÜ ALMAYINIZ !!!
Don't measurate on paper.

ÜRÜN KODU : 12*190
(Product Code)

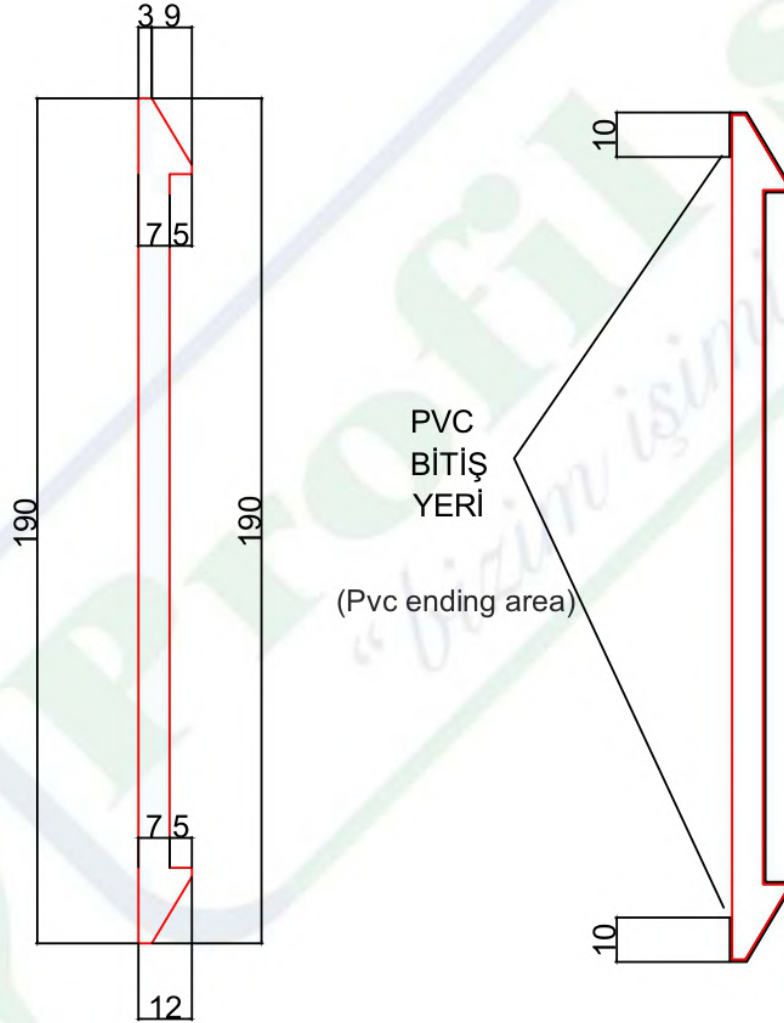

BÖLÜM SORUMLUSU NEJDET ALTINTOPRAK	BU ÇİZİM PROFİLSE - SİLAS ORMAN ÜRÜNLERİ'NE AİTTİR. İZINSİZ ÇOĞALTILMAMAK VE KOPYA EDİLMEKEMEK ŞARTI İLE İZİN VERİLMİŞTİR.	PVC ENİ : MDF MİKTARI : PLAKADAN ÇIKAN :	KSM ÖLÇÜCÜ :	KUTU İÇİ : KUTU İÇİ ADET :
ARGE SORUMLUSU DOĞUKAN DEMİR	THIS DRAWING PROFILE - SİLAS FOREST PRODUCTS WHAT TO DO. UNLOCKED AND COPY NOT ALLOWED WITH THE WRITTEN.	GENEL TOLERANS : PROFİL BOY TOLERANSI :	MATERIAL MM MDF	TARİH / DATE 16.01.2019

12 mm Profiles

PROFİLSE - SİLAS ORMAN ÜRÜNLERİ

KAĞIT ÜZERİNDEN ÖLÇÜ ALMAYINIZ !!!
Don't measure on paper.

ÜRÜN KODU : 12*40

(Product Code)

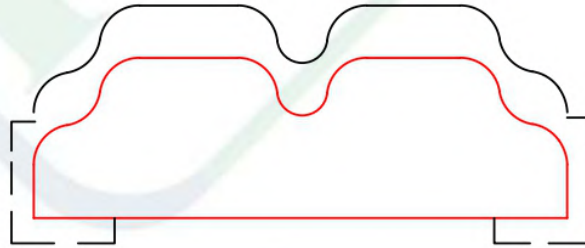
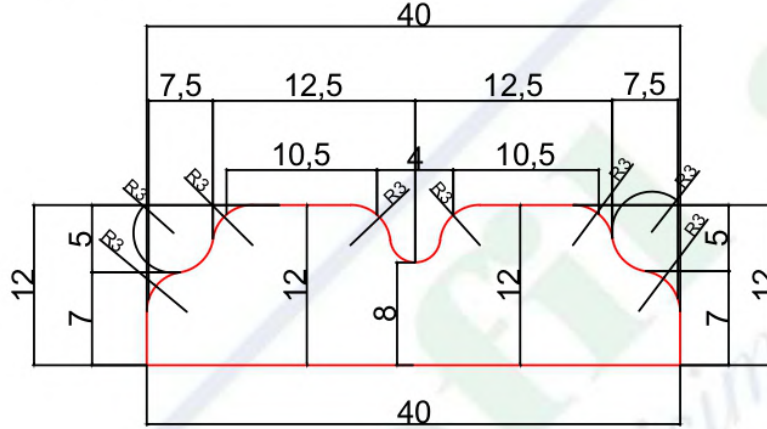

PVC BİTİŞ YERİ
(Pvc ending area)

BÖLÜM SORUMLUSU NEJDET ALTINTOPRAK	BU ÇİZİM PROFİLSE - SİLAS ORMAN ÜRÜNLERİ'NE AİTTİR. İZİNSİZ ÇOĞALTILMAMAK VE KOPYA EDİLMEKEMEK ŞARTI İLE İZİN VERİLMİŞTİR.	PVC ENİ : MDF MİKTARI : PLAKADAN ÇIKAN :	KSM ÖLÇÜCÜ :	KUTU İÇİ : KUTU İÇİ ADET :
ARGE SORUMLUSU DOĞUKAN DEMİR	THIS DRAWING PROFILE - SİLAS FOREST PRODUCTS WHAT TO DO. UNLOCKED AND COPY NOT ALLOWED WITH THE WRITTEN.	GENEL TOLERANS : PROFİL BOY TOLERANSI :	MATERİYAL MM MDF	TARİH / DATE 04.10.2018

12 mm Profiles

PROFİLSE - SİLAS ORMAN ÜRÜNLERİ

KAĞIT ÜZERİNDEN ÖLÇÜ ALMAYINIZ !!!
Don't measure on paper.

ÜRÜN KODU : 12*28
(Product Code)

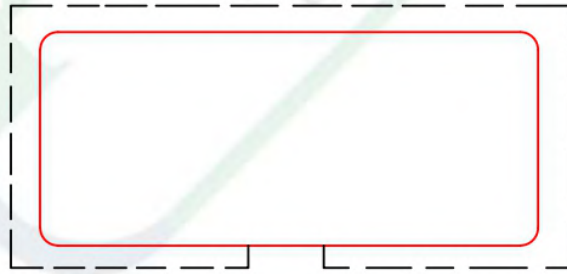
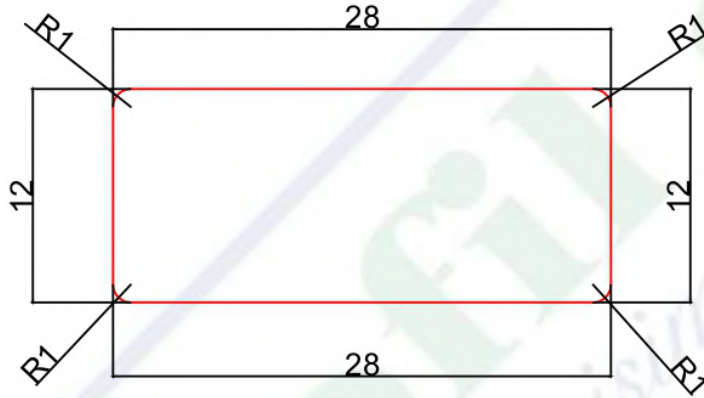

PVC BİTİŞ YERİ
(Pvc ending area)

BÖLÜM SORUMLUSU NEJDET ALTINTOPRAK	BU ÇİZİM PROFİLSE - SİLAS ORMAN ÜRÜNLERİ'NE AİTTİR. İZİNSİZ ÇOĞALTILMAMAK VE KOPYA EDİLMEK ŞARTI İLE İZİN VERİLMİŞTİR.	PVC ENİ : MDF MİKTARI : PLAKADAN ÇIKAN :	KSM ÖLÇÜCÜ :	KUTU İÇİ : KUTU İÇİ ADET :
ARGE SORUMLUSU DOĞUKAN DEMİR	THIS DRAWING PROFILE - SİLAS FOREST PRODUCTS WHAT TO DO. UNLOCKED AND COPY NOT ALLOWED WITH THE WRITTEN.	GENEL TOLERANS : PROFİL BOY TOLERANSI :	MATERİYAL MM MDF	TARİH / DATE 04.10.2018

12 mm Profiles

PROFİLSE - SİLAS ORMAN ÜRÜNLERİ

KAĞIT ÜZERİNDEN ÖLÇÜ ALMAYINIZ !!!
Don't measurate on paper.

ÜRÜN KODU : 12*60
(Product Code)

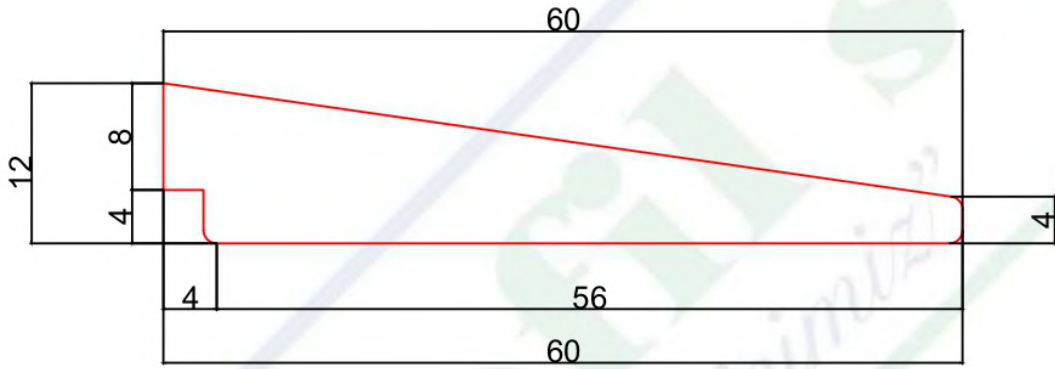

PVC
BİTİŞ
YERİ

(Pvc ending area)

BÖLÜM SORUMLUSU NEJDET ALTINTOPRAK	BU ÇİZİM PROFİLSE - SİLAS ORMAN ÜRÜNLERİ'NE AİTTİR. İZINSİZ ÇOĞALTILMAMAK VE KOPYA EDİLMEMEK ŞARTI İLE İZİN VERİLMİŞTİR.	PVC ENİ : MDF MİKTARI : PLAKADAN ÇIKAN :	KSM ÖLÇÜCÜ :	KUTU İÇİ : KUTU İÇİ ADET :
ARGE SORUMLUSU DOĞUKAN DEMİR	THIS DRAWING PROFILE - SİLAS FOREST PRODUCTS WHAT TO DO. UNLOCKED AND COPY NOT ALLOWED WITH THE WRITTEN.	GENEL TOLERANS : PROFL BOY TOLERANSI :	MATERİYAL MM MDF	TARİH / DATE 04.10.2018

12 mm Profiles

PROFİLSE - SİLAS ORMAN ÜRÜNLERİ

KAĞIT ÜZERİNDEN ÖLÇÜ ALMAYINIZ !!!
Don't measure on paper.

ÜRÜN KODU : 12*60
(Product Code)

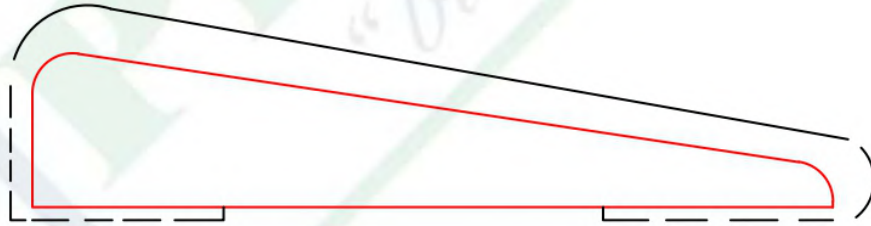
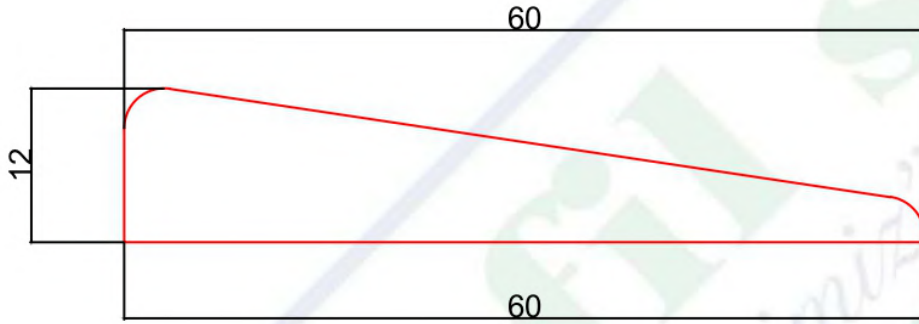

PVC BİTİŞ YERİ
(Pvc ending area)

BÖLÜM SORUMLUSU NEJDET ALTINTOPRAK	BU ÇİZİM PROFİLSE - SİLAS ORMAN ÜRÜNLERİ'NE AİTTİR. İZINSİZ ÇOĞALTILMAMAK VE KOPYA EDİLMEMEK ŞARTI İLE İZİN VERİLMİŞTİR.	PVC ENİ : MDF MİKTARI : PLAKADAN ÇIKAN :	KSM ÖLÇÜCÜ :	KUTU İÇİ : KUTU İÇİ ADET :
ARGE SORUMLUSU DOĞUKAN DEMİR	THIS DRAWING PROFILE - SİLAS FOREST PRODUCTS WHAT TO DO. UNLOCKED AND COPY NOT ALLOWED WITH THE WRITTEN.	GENEL TOLERANS : PROFİL BOY TOLERANSI :	MATERİYAL MM MDF	TARİH / DATE 04.10.2018

12 mm Profiles

PROFİLSE - SİLAS ORMAN ÜRÜNLERİ

KAĞIT ÜZERİNDEN ÖLÇÜ ALMAYINIZ !!!
Don't measurate on paper.

ÜRÜN KODU : 12*37
(Product Code)

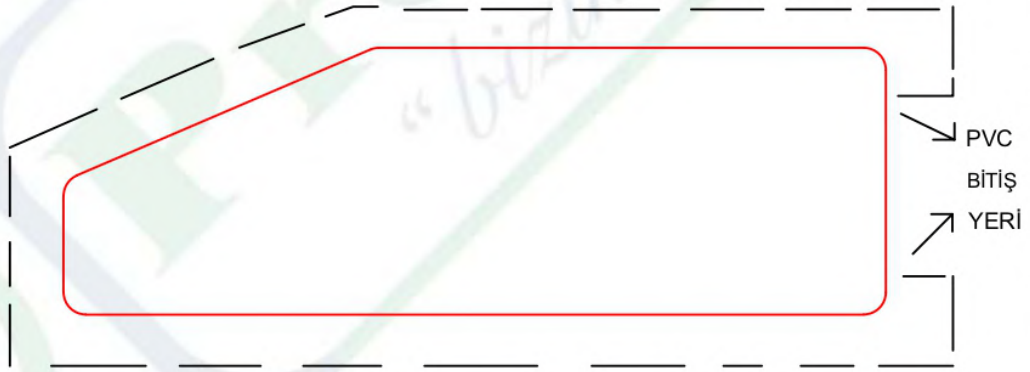
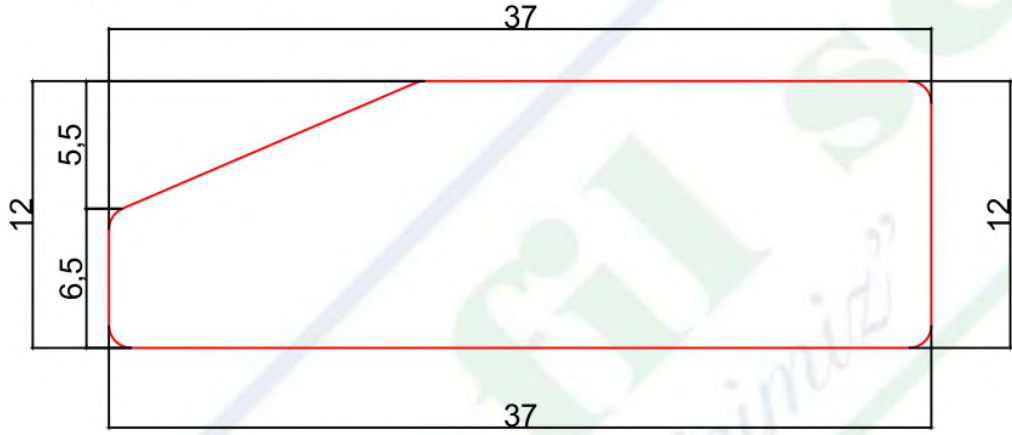

(Pvc ending area)

BÖLÜM SORUMLUSU NEJDET ALTINTOPRAK	BU ÇİZİM PROFİLSE - SİLAS ORMAN ÜRÜNLERİ'NE AİTTİR. İZINSİZ ÇOĞALTILMAMAK VE KOPYA EDİLMEKEMEK ŞARTI İLE İZİN VERİLMİŞTİR.	PVC ENİ : MDF MİKTARI : PLAKADAN ÇIKAN :	KSM ÖLÇÜCÜ :	KUTU İÇİ : KUTU İÇİ ADET :
ARGE SORUMLUSU DOĞUKAN DEMİR	THIS DRAWING PROFILE - SİLAS FOREST PRODUCTS WHAT TO DO. UNLOCKED AND COPY NOT ALLOWED WITH THE WRITTEN.	GENEL TOLERANS : PROFİL BOY TOLERANSI :	MATERİYAL MM MDF	TARİH / DATE 04.10.2018

12 mm Profiles

PROFİLSE - SİLAS ORMAN ÜRÜNLERİ

KAĞIT ÜZERİNDEN ÖLÇÜ ALMAYINIZ !!!
Don't measure on paper.

ÜRÜN KODU : 12*40
(Product Code)

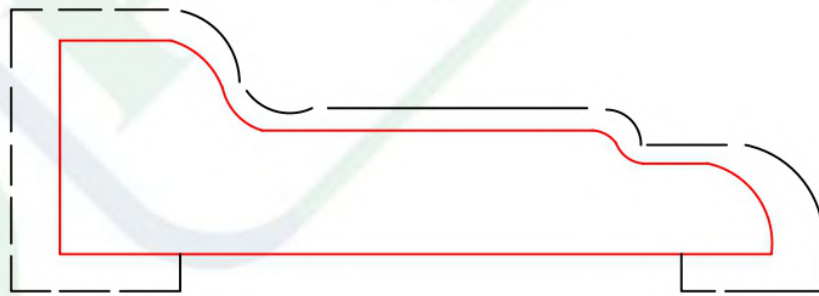
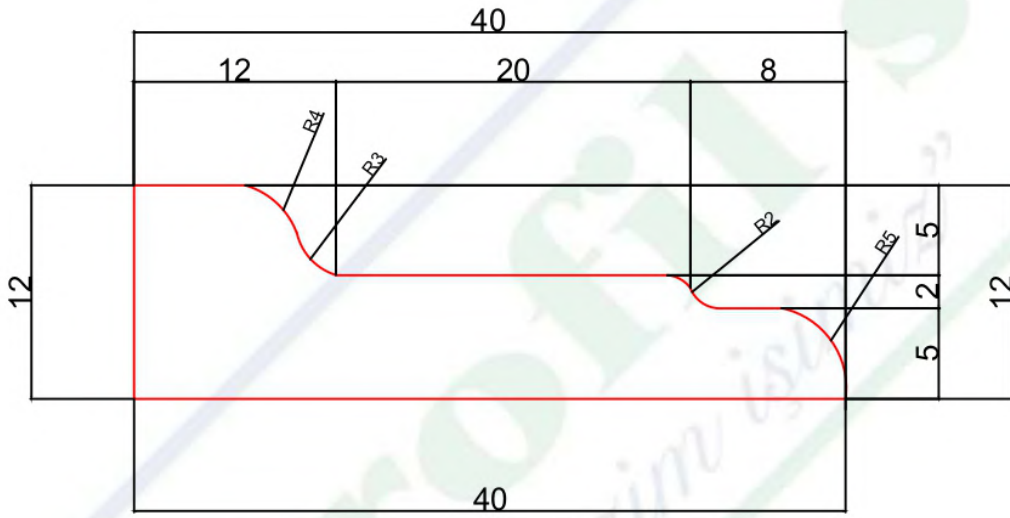

PVC BİTİŞ YERİ
(Pvc ending area)

BÖLÜM SORUMLUSU NEJDET ALTINTOPRAK	BU ÇİZİM PROFİLSE - SİLAS ORMAN ÜRÜNLERİ'NE AİTTİR. İZINSİZ ÇOĞALTILMAMAK VE KOPYA EDİLMEMEK ŞARTI İLE İZİN VERİLMİŞTİR.	PVC ENİ : MDF MİKTARI : PLAKADAN ÇIKAN :	KSM ÖLÇÜCÜ :	KUTU İÇİ : KUTU İÇİ ADET :
ARGE SORUMLUSU DOĞUKAN DEMİR	THIS DRAWING PROFILE - SILAS FOREST PRODUCTS WHAT TO DO. UNLOCKED AND COPY NOT ALLOWED WITH THE WRITTEN.	GENEL TOLERANS : PROFİL BOY TOLERANSI :	MATERİYAL MM MDF	TARİH / DATE 06.12.2018

12 mm Profiles

PROFİLSE - SİLAS ORMAN ÜRÜNLERİ

KAĞIT ÜZERİNDEN ÖLÇÜ ALMAYINIZ !!!
Don't measure on paper.

ÜRÜN KODU : 12*50
(Product Code)

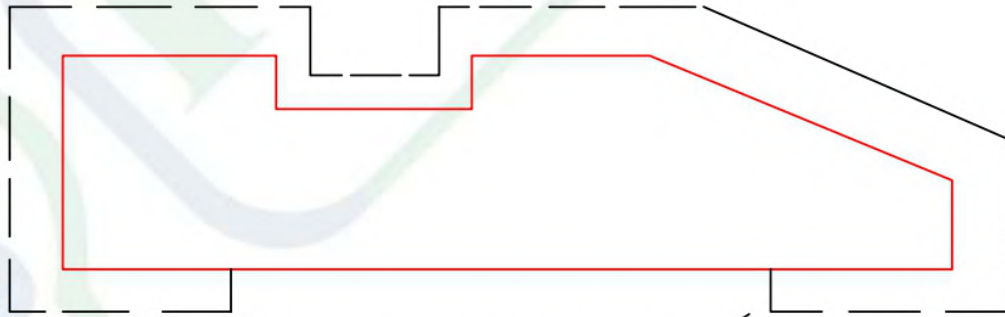
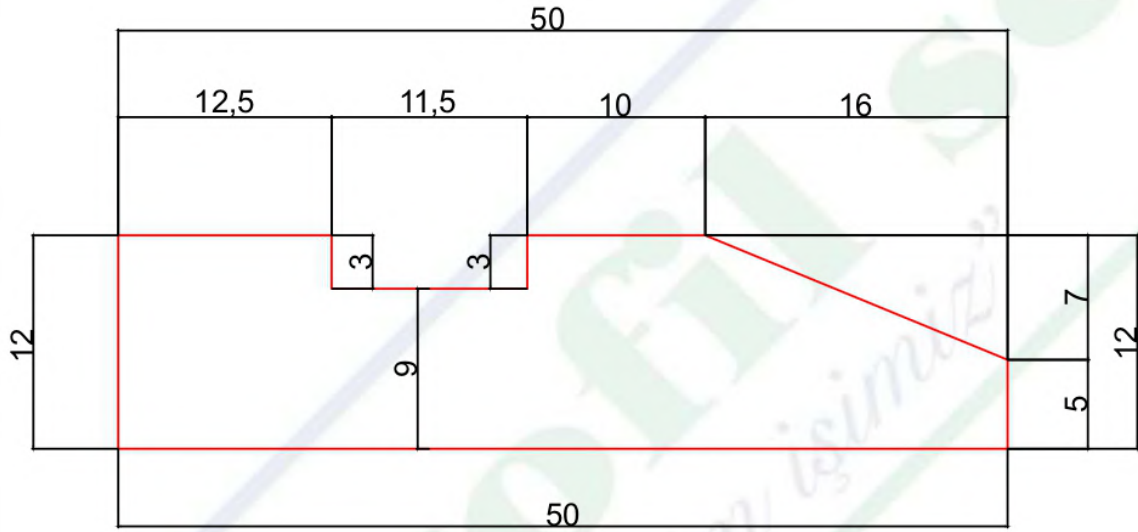

PVC BİTİŞ YERİ

(Pvc ending area)

BÖLÜM SORUMLUSU NEJDET ALTINTOPRAK	BU ÇİZİM PROFİLSE - SİLAS ORMAN ÜRÜNLERİ'NE AİTTİR. İZİNSİZ ÇOĞALTILMAMAK VE KOPYA EDİLMEKEMEK ŞARTI İLE İZİN VERİLMİŞTİR.	PVC ENİ : MDF MİKTARI : PLAKADAN ÇIKAN :	KSM ÖLÇÜCÜ :	KUTU İÇİ : KUTU İÇİ ADET :
ARGE SORUMLUSU DOĞUKAN DEMİR	THIS DRAWING PROFILE - SILAS FOREST PRODUCTS WHAT TO DO. UNLOCKED AND COPY NOT ALLOWED WITH THE WRITTEN.	GENEL TOLERANS : PROFL BOY TOLERANSI :	MATERIAL MM MDF	TARİH / DATE 24.12.2018

12 mm Profiles

PROFİLSE - SİLAS ORMAN ÜRÜNLERİ

KAĞIT ÜZERİNDEN ÖLÇÜ ALMAYINIZ !!!
Don't measurate on paper.

ÜRÜN KODU: 12*115
(Product Code)

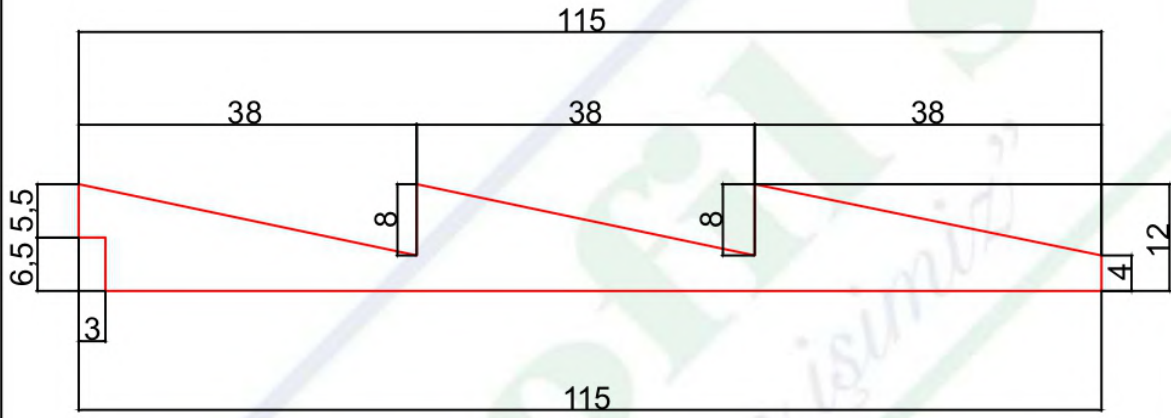

BÖLÜM SORUMLUSU NEJDET ALTINTOPRAK	BU ÇİZİM PROFİLSE - SİLAS ORMAN ÜRÜNLERİ'NE AİTTİR. İZINSİZ ÇOĞALTILMAMAK VE KOPYA EDİLMEK ŞARTI İLE İZİN VERİLMİŞTİR.	PVC ENİ : MDF MİKTARI : PLAKADAN ÇIKAN :	KSM ÖLÇÜCÜ :	KUTU İÇİ : KUTU İÇİ ADET :
ARGE SORUMLUSU DOĞUKAN DEMİR	THIS DRAWING PROFILE - SILAS FOREST PRODUCTS WHAT TO DO. UNLOCKED AND COPY NOT ALLOWED WITH THE WRITTEN.	GENEL TOLERANS : PROFİL BOY TOLERANSI :	MATERIAL MM MDF	TARİH / DATE 17.12.2018

12 mm Profiles

PROFİLSE - SİLAS ORMAN ÜRÜNLERİ

KAĞIT ÜZERİNDEN ÖLÇÜ ALMAYINIZ !!!
Don't measure on paper.

ÜRÜN KODU: 12*30
(Product Code)

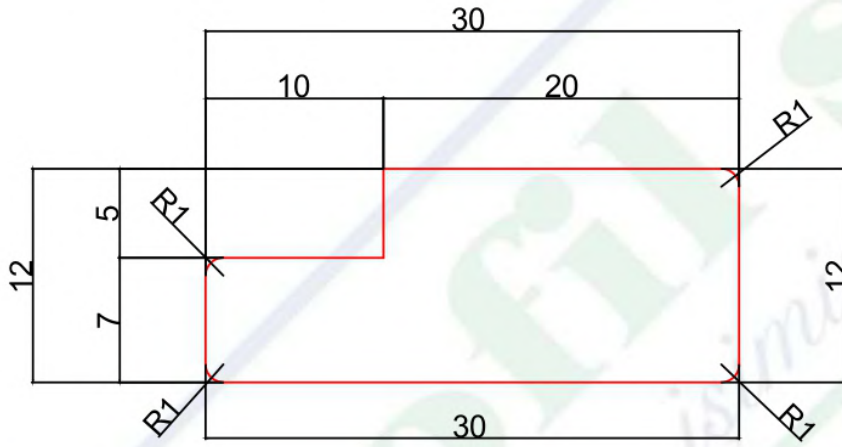

(Pvc ending area)

PVC BİTİŞ YERİ

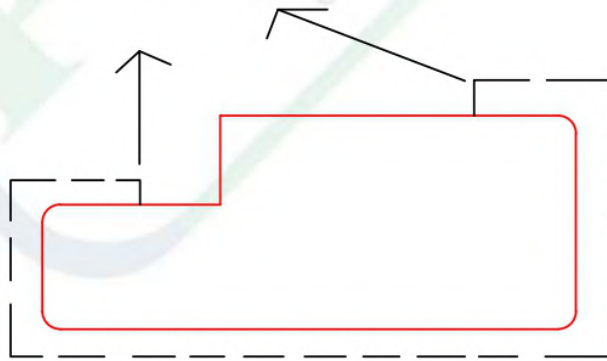

BÖLÜM SORUMLUSU NEJDET ALTINTOPRAK	BU ÇİZİM PROFİLSE - SİLAS ORMAN ÜRÜNLERİ'NE AİTTİR. İZİNSİZ ÇOĞALTILMAMAK VE KOPYA EDİLMEMEK ŞARTI İLE İZİN VERİLMİŞTİR.	PVC ENİ : MDF MİKTARI : PLAKADAN ÇIKAN :	KSM ÖLÇÜCÜ :	KUTU İÇİ : KUTU İÇİ ADET :
ARGE SORUMLUSU DOĞUKAN DEMİR	THIS DRAWING PROFILE - SİLAS FOREST PRODUCTS WHAT TO DO. UNLOCKED AND COPY NOT ALLOWED WITH THE WRITTEN.	GENEL TOLERANS : PROFİL BOY TOLERANSI :	MATERİYAL MM MDF	TARİH / DATE 04.12.2018

14-15-16 mm Profiles

PROFİLSE - SİLAS ORMAN ÜRÜNLERİ

KAGIT ÜZERİNDEN ÖLÇÜ ALMAYINIZ !!!

ÜRÜN KODU : 14*36
(Product Code)

Don't measurate on paper.

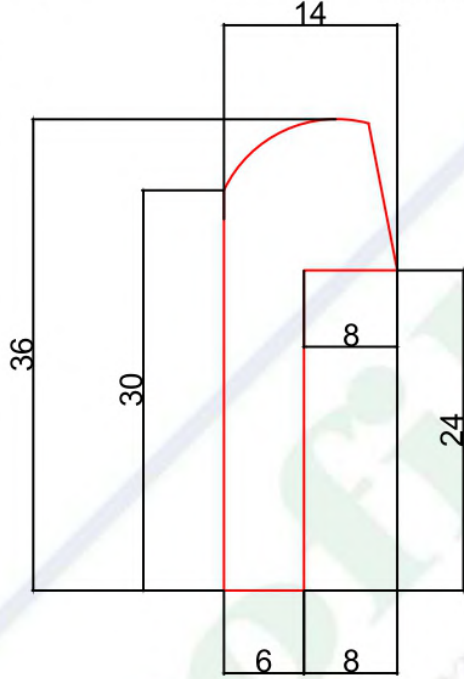

BÖLÜM SORUMLUSU NEJDET ALTINTOPRAK	BU ÇİZİM PROFİLSE - SİLAS ORMAN ÜRÜNLERİ'NE AİTTİR. İZINSİZ ÇOĞALTILMAMAK VE KOPYA EDİLMEMEK ŞARTI İLE İZİN VERİLMİŞTİR.	PVC ENİ : MDF MİKTARI : PLAKADAN ÇIKAN :	KSM ÖLÇÜCÜ :	KUTU İÇİ : KUTU İÇİ ADET :
ARGE SORUMLUSU DOĞUKAN DEMİR	THIS DRAWING PROFILE - SİLAS FOREST PRODUCTS WHAT TO DO. UNLOCKED AND COPY NOT ALLOWED WITH THE WRITTEN.	GENEL TOLERANS : PROFL BOY TOLERANSI :	MATERİYAL MM MDF	TARİH / DATE 12.10.2018

14-15-16 mm Profiles

PROFİLSE - SİLAS ORMAN ÜRÜNLERİ

KAĞIT ÜZERİNDEN ÖLÇÜ ALMAYINIZ !!!

ÜRÜN KODU : 14*18
(Product Code)

Don't measurate on paper.

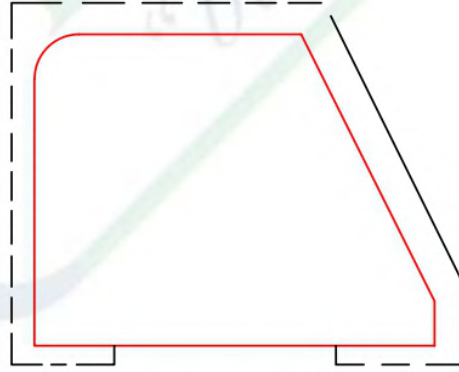
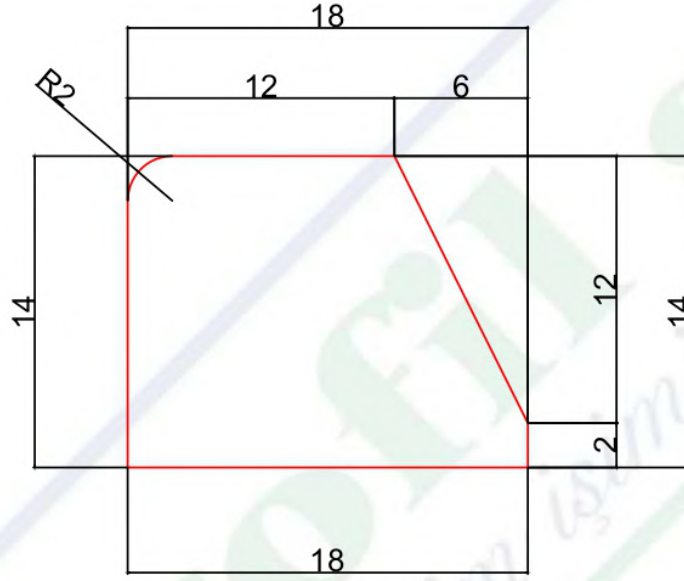

PVC BİTİŞ YERİ
(Pvc ending area)

BÖLÜM SORUMLUSU NEJDET ALTINTOPRAK	BU ÇİZİM PROFİLSE - SİLAS ORMAN ÜRÜNLERİ'NE AİTTİR. İZİNSİZ ÇOĞALTILMAMAK VE KOPYA EDİLMEKEMEK ŞARTI İLE İZİN VERİLMİŞTİR.	PVC ENİ : MDF MİKTARI : PLAKADAN ÇIKAN :	KSM ÖLÇÜCÜ :	KUTU İÇİ : KUTU İÇİ ADET :
ARGE SORUMLUSU DOĞUKAN DEMİR	THIS DRAWING PROFILE - SİLAS FOREST PRODUCTS WHAT TO DO. UNLOCKED AND COPY NOT ALLOWED WITH THE WRITTEN.	GENEL TOLERANS : PROFİL BOY TOLERANSI :	MATERİYAL MM MDF	TARİH / DATE 10.10.2018

14-15-16 mm Profiles

PROFİLSE - SİLAS ORMAN ÜRÜNLERİ

KAĞIT ÜZERİNDEN ÖLÇÜ ALMAYINIZ !!!
Don't measurate on paper.

ÜRÜN KODU : 15*50
(Product Code)

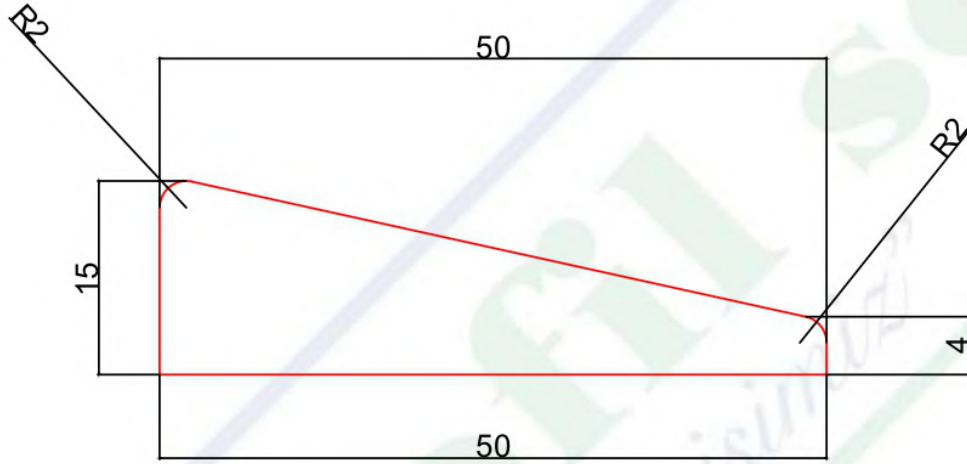

PVC BİTİŞ YERİ
(Pvc ending area)

BÖLÜM SORUMLUSU NEJDET ALTINTOPRAK	BU ÇİZİM PROFİLSE - SİLAS ORMAN ÜRÜNLERİ'NE AİTTİR. İZINSİZ ÇOĞALTILMAMAK VE KOPYA EDİLMEMEK ŞARTI İLE İZİN VERİLMİŞTİR.	PVC ENİ : MDF MİKTARI : PLAKADAN ÇIKAN :	KSM ÖLÇÜCÜ :	KUTU İÇİ : KUTU İÇİ ADET :
ARGE SORUMLUSU DOĞUKAN DEMİR	THIS DRAWING PROFILE - SİLAS FOREST PRODUCTS WHAT TO DO. UNLOCKED AND COPY NOT ALLOWED WITH THE WRITTEN.	GENEL TOLERANS : PROFİL BOY TOLERANSI :	MATERİYAL MM MDF	TARİH / DATE 19.11.2018

14-15-16 mm Profiles

PROFİLSE - SİLAS ORMAN ÜRÜNLERİ

KAĞIT ÜZERİNDEN ÖLÇÜ ALMAYINIZ !!!

Don't measure on paper.

ÜRÜN KODU : 15*30

(Product Code)

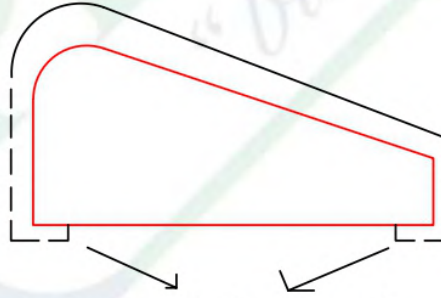
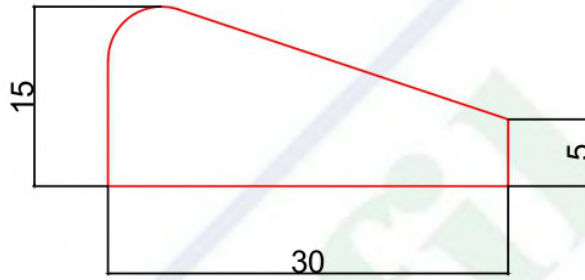

PVC BİTİŞ YERİ

(Pvc ending area)

BÖLÜM SORUMLUSU NEJDET ALTINTOPRAK	BU ÇİZİM PROFİLSE - SİLAS ORMAN ÜRÜNLERİ'NE AİTTİR. İZINSİZ ÇOĞALTILMAMAK VE KOPYA EDİLMEMEK ŞARTI İLE İZİN VERİLMİŞTİR.	PVC ENİ : MDF MİKTARI : PLAKADAN ÇIKAN :	KSM ÖLÇÜCÜ :	KUTU İÇİ : KUTU İÇİ ADET :
ARGE SORUMLUSU DOĞUKAN DEMİR	THIS DRAWING PROFILE - SİLAS FOREST PRODUCTS WHAT TO DO. UNLOCKED AND COPY NOT ALLOWED WITH THE WRITTEN.	GENEL TOLERANS : PROFL BOY TOLERANSI :	MATERİYAL MM MDF	TARİH / DATE 12.11.2018

14-15-16 mm Profiles

PROFİLSE - SİLAS ORMAN ÜRÜNLERİ

KAĞIT ÜZERİNDEN ÖLÇÜ ALMAYINIZ !!!
Don't measurate on paper.

ÜRÜN KODU : 15*28

(Product Code)

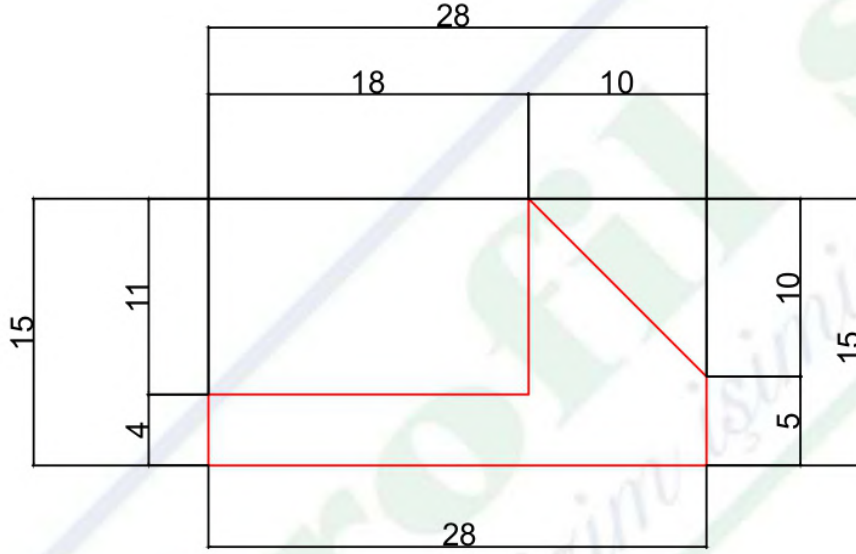

(Pvc ending area)

PVC BİTİŞ YERİ

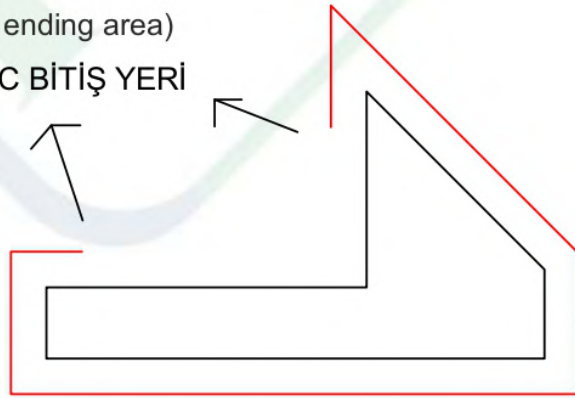

BÖLÜM SORUMLUSU NEJDET ALTINTOPRAK	BU ÇİZİM PROFİLSE - SİLAS ORMAN ÜRÜNLERİ'NE AİTTİR. İZINSİZ ÇOĞALTILMAMAK VE KOPYA EDİLMEMEK ŞARTI İLE İZİN VERİLMİŞTİR.	PVC ENİ : MDF MİKTARI : PLAKADAN ÇIKAN :	KSM ÖLÇÜCÜ :	KUTU İÇİ : KUTU İÇİ ADET :
ARGE SORUMLUSU DOĞUKAN DEMİR	THIS DRAWING PROFILE - SİLAS FOREST PRODUCTS WHAT TO DO. UNLOCKED AND COPY NOT ALLOWED WITH THE WRITTEN.	GENEL TOLERANS : PROFİL BOY TOLERANSI :	MATERİYAL MM MDF	TARİH / DATE 19.02.2019

14-15-16 mm Profiles

PROFİLSE - SİLAS ORMAN ÜRÜNLERİ

KAĞIT ÜZERİNDEN ÖLÇÜ ALMAYINIZ !!!
Don't measure on paper.

ÜRÜN KODU : 15*30
(Product Code)

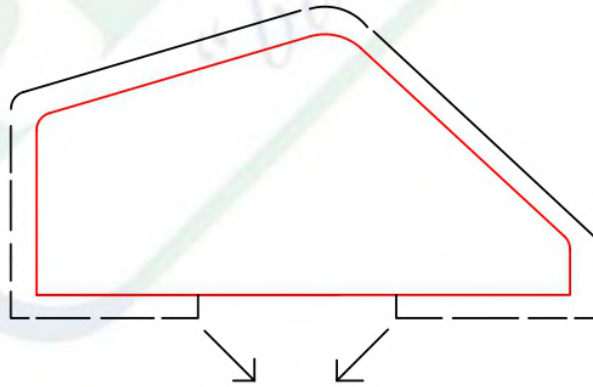
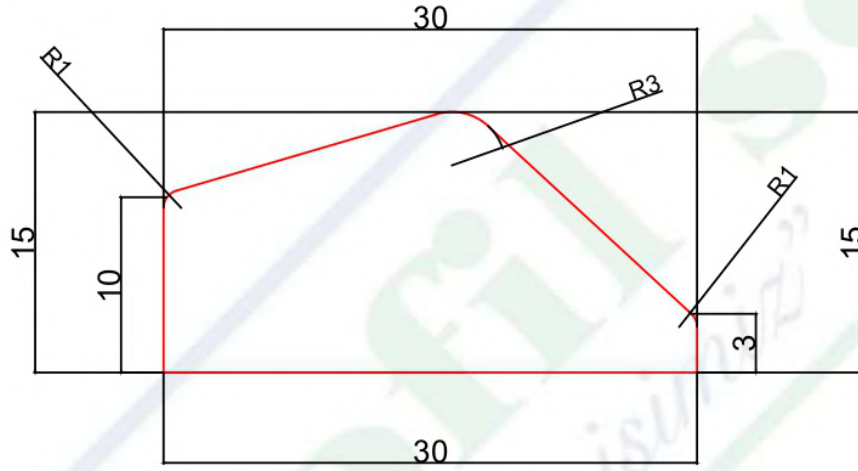

PVC BİTİŞ YERİ

(Pvc ending area)

BÖLÜM SORUMLUSU NEJDET ALTINTOPRAK	BU ÇİZİM PROFİLSE - SİLAS ORMAN ÜRÜNLERİ'NE AİTTİR. İZİNSİZ ÇOĞALTILMAMAK VE KOPYA EDİLMEK ŞARTI İLE İZİN VERİLMİŞTİR.	PVC ENİ : MDF MİKTARI : PLAKADAN ÇIKAN :	KSM ÖLÇÜCÜ :	KUTU İÇİ : KUTU İÇİ ADET :
ARGE SORUMLUSU DOĞUKAN DEMİR	THIS DRAWING PROFILE - SİLAS FOREST PRODUCTS WHAT TO DO. UNLOCKED AND COPY NOT ALLOWED WITH THE WRITTEN.	GENEL TOLERANS : PROFİL BOY TOLERANSI :	MATERİYAL MM MDF	TARİH / DATE 08.04.2019

14-15-16 mm Profiles

PROFİLSE - SİLAS ORMAN ÜRÜNLERİ

KAĞIT ÜZERİNDEN ÖLÇÜ ALMAYINIZ !!!

Don't measurate on paper.

ÜRÜN KODU : 15*28
(Product Code)

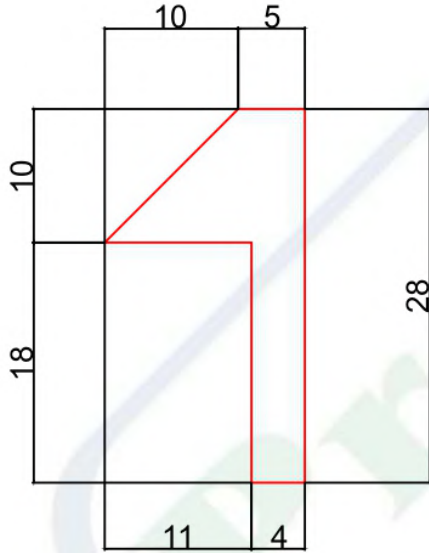

BÖLÜM SORUMLUSU NEJDET ALTINTOPRAK	BU ÇİZİM PROFİLSE - SİLAS ORMAN ÜRÜNLERİ'NE AİTTİR. İZİNSİZ ÇOĞALTILMAMAK VE KOPYA EDİLMEKEMEK ŞARTI İLE İZİN VERİLMİŞTİR.	PVC ENİ : MDF MİKTARI : PLAKADAN ÇIKAN :	KSM ÖLÇÜCÜ :	KUTU İÇİ : KUTU İÇİ ADET :
ARGE SORUMLUSU DOĞUKAN DEMİR	THIS DRAWING PROFILE - SİLAS FOREST PRODUCTS WHAT TO DO. UNLOCKED AND COPY NOT ALLOWED WITH THE WRITTEN.	GENEL TOLERANS : PROFİL BOY TOLERANSI :	MATERİYAL MM MDF	TARİH / DATE 09.11.2018

14-15-16 mm Profiles

PROFİLSE - SİLAS ORMAN ÜRÜNLERİ

KAĞIT ÜZERİNDEN ÖLÇÜ ALMAYINIZ !!!
Don't measure on paper.

ÜRÜN KODU : 15*18

(Product Code)

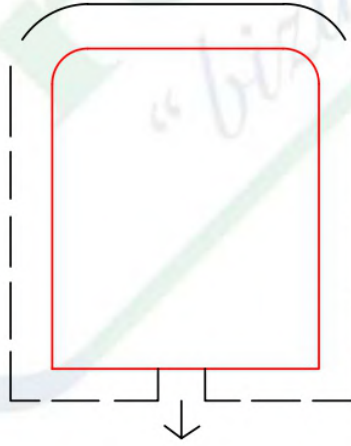
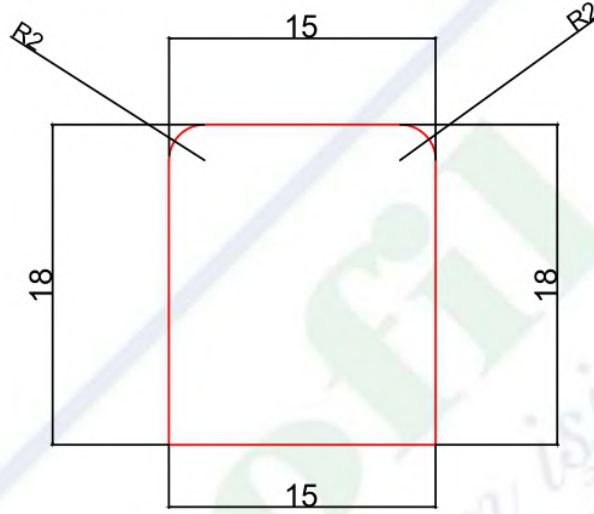

PVC BİTİŞ YERİ

(Pvc ending area)

BÖLÜM SORUMLUSU NEJDET ALTINTOPRAK	BU ÇİZİM PROFİLSE - SİLAS ORMAN ÜRÜNLERİ'NE AİTTİR. İZİNSİZ ÇOĞALTILMAMAK VE KOPYA EDİLMEMEK ŞARTI İLE İZİN VERİLMİŞTİR.	PVC ENİ : MDF MİKTARI : PLAKADAN ÇIKAN :	KSM ÖLÇÜCÜ :	KUTU İÇİ : KUTU İÇİ ADET :
ARGE SORUMLUSU DOĞUKAN DEMİR	THIS DRAWING PROFILE - SİLAS FOREST PRODUCTS WHAT TO DO. UNLOCKED AND COPY NOT ALLOWED WITH THE WRITTEN.	GENEL TOLERANS : PROFİL BOY TOLERANSI :	MATERİYAL MM MDF	TARİH / DATE 2.01.2019

14-15-16 mm Profiles

PROFİLSE - SİLAS ORMAN ÜRÜNLERİ

KAĞIT ÜZERİNDEN ÖLÇÜ ALMAYINIZ !!!
Don't measure on paper.

ÜRÜN KODU : 16*50-14
(Product Code)

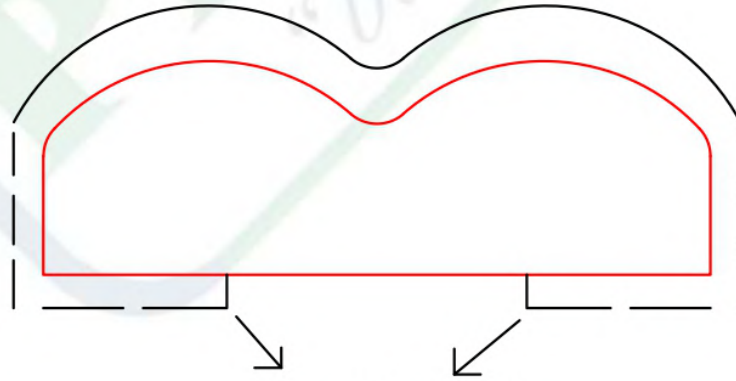
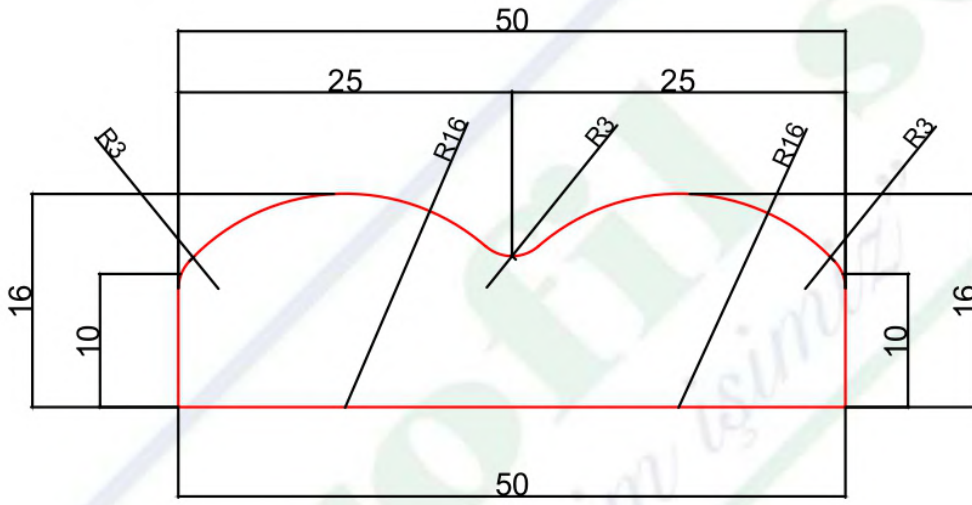

PVC BİTİŞ YERİ

(Pvc ending area)

BÖLÜM SORUMLUSU NEJDET ALTINTOPRAK	BU ÇİZİM PROFİLSE - SİLAS ORMAN ÜRÜNLERİ'NE AİTTİR. İZINSİZ ÇOĞALTILMAMAK VE KOPYA EDİLMEKEMEK ŞARTI İLE İZİN VERİLMİŞTİR.	PVC ENİ : MDF MİKTARI : PLAKADAN ÇIKAN :	KSM ÖLÇÜCÜ :	KUTU İÇİ : KUTU İÇİ ADET :
ARGE SORUMLUSU DOĞUKAN DEMİR	THIS DRAWING PROFILE - SİLAS FOREST PRODUCTS WHAT TO DO. UNLOCKED AND COPY NOT ALLOWED WITH THE WRITTEN.	GENEL TOLERANS : PROFİL BOY TOLERANSI :	MATERİYAL MM MDF	TARİH / DATE 18.01.2019

14-15-16 mm Profiles

PROFİLSE - SİLAS ORMAN ÜRÜNLERİ

KAĞIT ÜZERİNDEN ÖLÇÜ ALMAYINIZ !!!

Don't measurate on paper.

ÜRÜN KODU : 16*40

(Product Code)

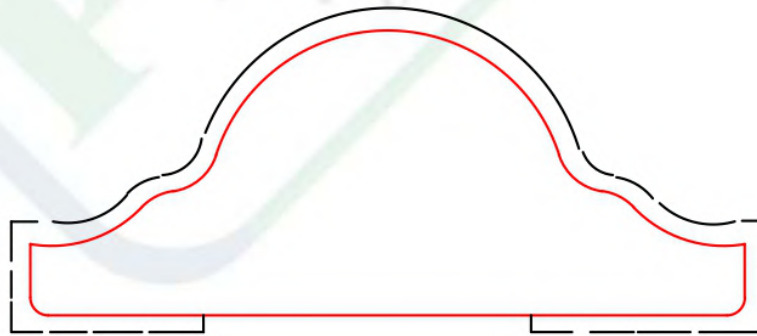
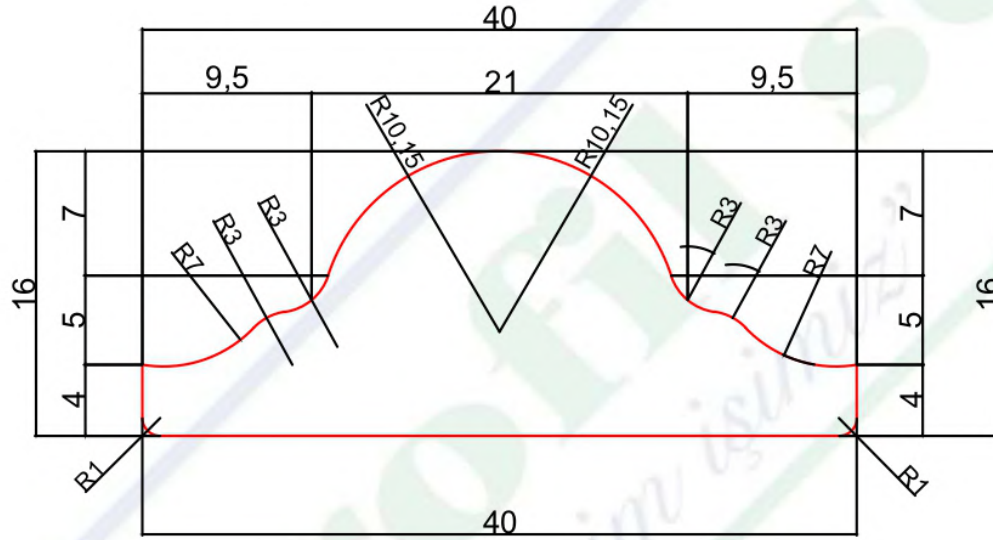

PVC BİTİŞ YERİ
(Pvc ending area)

BÖLÜM SORUMLUSU NEJDET ALTINTOPRAK	BU ÇİZİM PROFİLSE - SİLAS ORMAN ÜRÜNLERİ'NE AİTTİR. İZİNSİZ ÇOĞALTILMAMAK VE KOPYA EDİLMEYEMEK ŞARTI İLE İZİN VERİLMİŞTİR.	PVC ENİ : MDF MİKTARI : PLAKADAN ÇIKAN :	KSM ÖLÇÜCÜ :	KUTU İÇİ : KUTU İÇİ ADET :
ARGE SORUMLUSU DOĞUKAN DEMİR	THIS DRAWING PROFILE - SİLAS FOREST PRODUCTS WHAT TO DO. UNLOCKED AND COPY NOT ALLOWED WITH THE WRITTEN.	GENEL TOLERANS : PROFİL BOY TOLERANSI :	MATERİYAL MM MDF	TARİH / DATE 17.04.2019

14-15-16 mm Profiles

PROFİLSE - SİLAS ORMAN ÜRÜNLERİ

KAĞIT ÜZERİNDEN ÖLÇÜ ALMAYINIZ !!!
Don't measure on paper.

ÜRÜN KODU : 16*18
(Product Code)

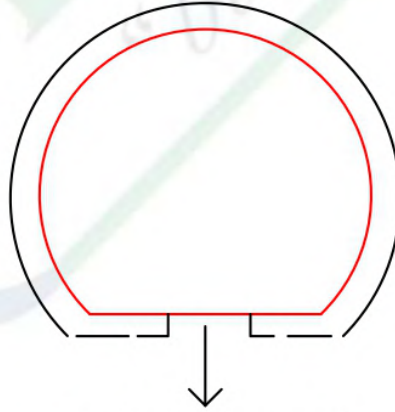
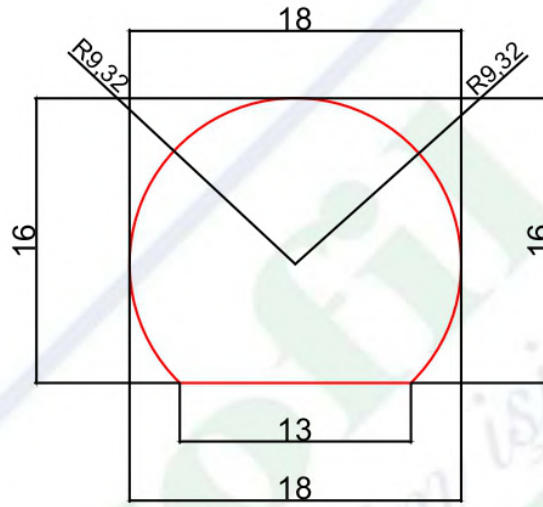

PVC BİTİŞ YERİ
(Pvc ending area)

BÖLÜM SORUMLUSU NEJDET ALTINTOPRAK	BU ÇİZİM PROFİLSE - SİLAS ORMAN ÜRÜNLERİ'NE AİTTİR. İZİNSİZ ÇOĞALTILMAMAK VE KOPYA EDİLMEMEK ŞARTI İLE İZİN VERİLMİŞTİR.	PVC ENİ : MDF MİKTARI : PLAKADAN ÇIKAN :	KSM ÖLÇÜCÜ :	KUTU İÇİ : KUTU İÇİ ADET :
ARGE SORUMLUSU DOĞUKAN DEMİR	THIS DRAWING PROFILE - SİLAS FOREST PRODUCTS WHAT TO DO. UNLOCKED AND COPY NOT ALLOWED WITH THE WRITTEN.	GENEL TOLERANS : PROFİL BOY TOLERANSI :	MATERİYAL MM MDF	TARİH / DATE 17.04.2019

14-15-16 mm Profiles

PROFİLSE - SİLAS ORMAN ÜRÜNLERİ

KAĞIT ÜZERİNDEN ÖLÇÜ ALMAYINIZ !!!
Don't measure on paper.

ÜRÜN KODU : 16*24

(Product Code)

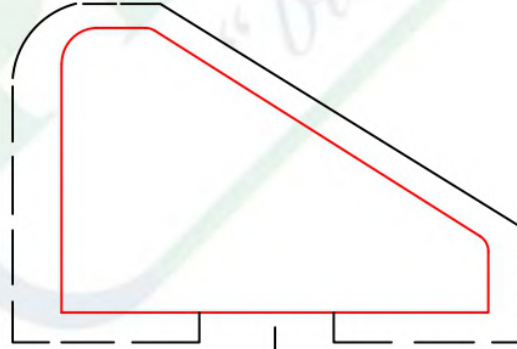
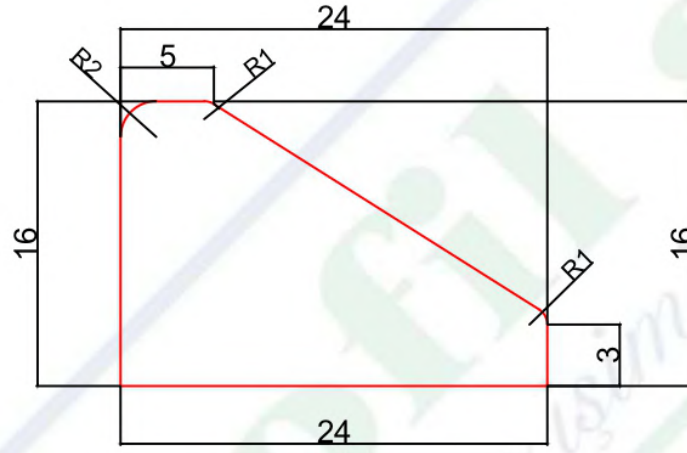

PVC BİTİŞ YERİ
(Pvc ending area)

BÖLÜM SORUMLUSU NEJDET ALTINTOPRAK	BU ÇİZİM PROFİLSE - SİLAS ORMAN ÜRÜNLERİ'NE AİTTİR. İZINSİZ ÇOĞALTILMAMAK VE KOPYA EDİLMEMEK ŞARTI İLE İZİN VERİLMİŞTİR.	PVC ENİ : MDF MİKTARI : PLAKADAN ÇIKAN :	KSM ÖLÇÜCÜ :	KUTU İÇİ : KUTU İÇİ ADET :
ARGE SORUMLUSU DOĞUKAN DEMİR	THIS DRAWING PROFILE - SİLAS FOREST PRODUCTS WHAT TO DO. UNLOCKED AND COPY NOT ALLOWED WITH THE WRITTEN.	GENEL TOLERANS : PROFİL BOY TOLERANSI :	MATERIAL MM MDF	TARİH / DATE 16.04.2019

14-15-16 mm Profiles

PROFİLSE - SİLAS ORMAN ÜRÜNLERİ

KAĞIT ÜZERİNDEN ÖLÇÜ ALMAYINIZ !!!
Don't measure on paper.

ÜRÜN KODU : 16*16

(Product Code)

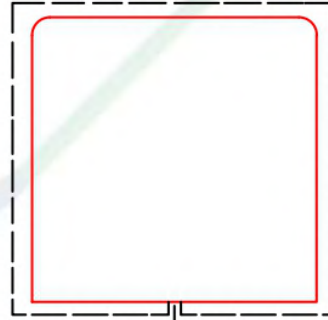
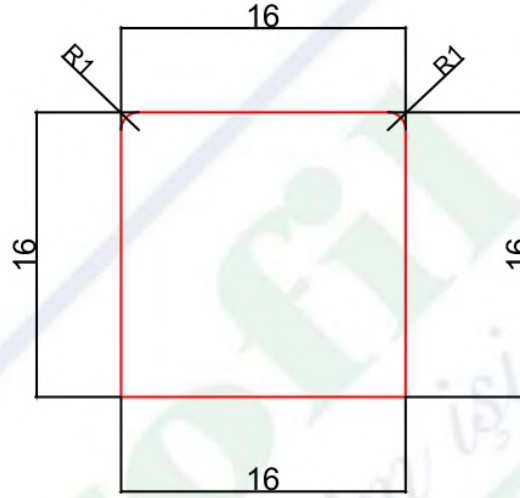

PVC BİTİŞ YERİ
(Pvc ending area)

BÖLÜM SORUMLUSU NEJDET ALTINTOPRAK	BU ÇİZİM PROFİLSE - SİLAS ORMAN ÜRÜNLERİ'NE AİTTİR. İZINSİZ ÇOĞALTILMAMAK VE KOPYA EDİLMEMEK ŞARTI İLE İZİN VERİLMİŞTİR.	PVC ENİ : MDF MİKTARI : PLAKADAN ÇIKAN :	KSM ÖLÇÜCÜ :	KUTU İÇİ : KUTU İÇİ ADET :
ARGE SORUMLUSU DOĞUKAN DEMİR	THIS DRAWING PROFILE - SİLAS FOREST PRODUCTS WHAT TO DO. UNLOCKED AND COPY NOT ALLOWED WITH THE WRITTEN.	GENEL TOLERANS : PROFL BOY TOLERANSI :	MATERIAL MM MDF	TARİH / DATE 16.04.2019

14-15-16 mm Profiles

PROFİLSE - SİLAS ORMAN ÜRÜNLERİ

KAĞIT ÜZERİNDEN ÖLÇÜ ALMAYINIZ !!!

ÜRÜN KODU : 16*22

Don't measurate on paper.

(Product Code)

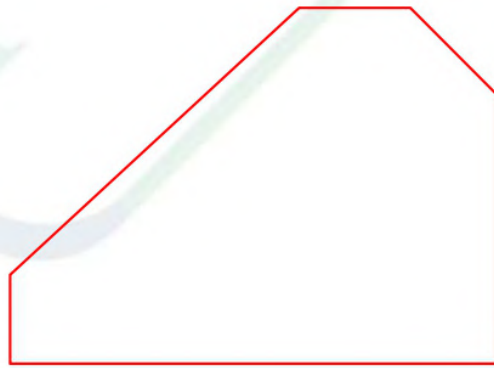
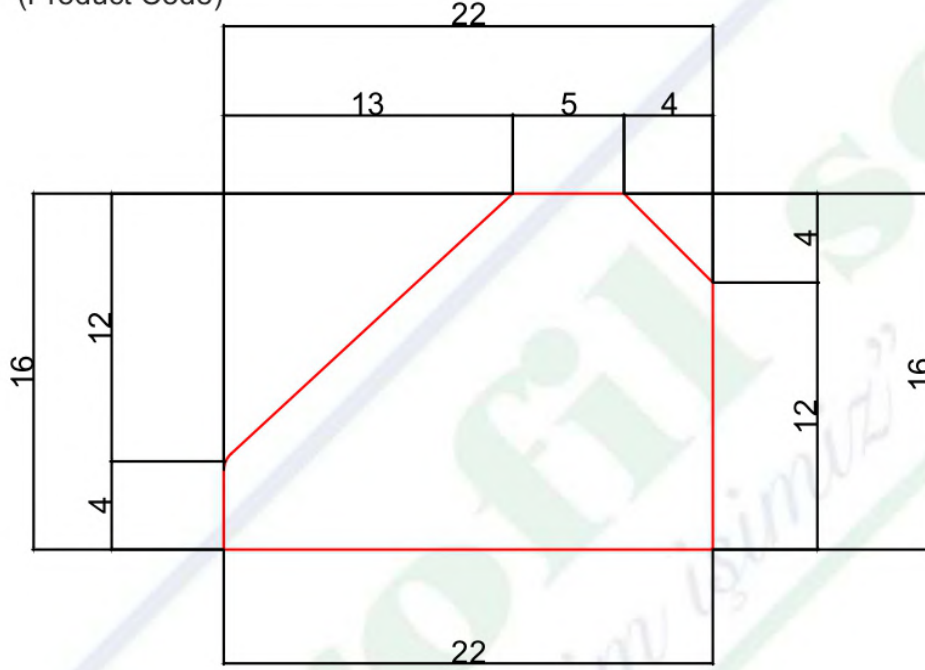

BÖLÜM SORUMLUSU NEJDET ALTINTOPRAK	BU ÇİZİM PROFİLSE - SİLAS ORMAN ÜRÜNLERİ'NE AİTTİR. İZİNSİZ ÇOĞALTILMAMAK VE KOPYA EDİLMEMEK ŞARTI İLE İZİN VERİLMİŞTİR.	PVC ENİ : MDF MİKTARI : PLAKADAN ÇIKAN :	KSM ÖLÇÜCÜ :	KUTU İÇİ : KUTU İÇİ ADET :
ARGE SORUMLUSU DOĞUKAN DEMİR	THIS DRAWING PROFILE - SİLAS FOREST PRODUCTS WHAT TO DO. UNLOCKED AND COPY NOT ALLOWED WITH THE WRITTEN.	GENEL TOLERANS : PROFİL BOY TOLERANSI :	MATERIAL MM MDF	TARİH / DATE 17.10.2018

14-15-16 mm Profiles

PROFİLSE - SİLAS ORMAN ÜRÜNLERİ

KAĞIT ÜZERİNDEN ÖLÇÜ ALMAYINIZ !!!
Don't measure on paper.

ÜRÜN KODU : 16*53
(Product Code)

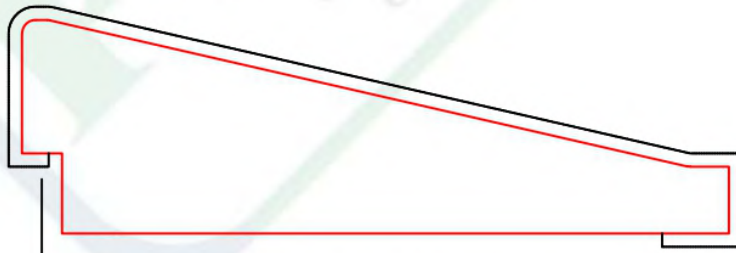
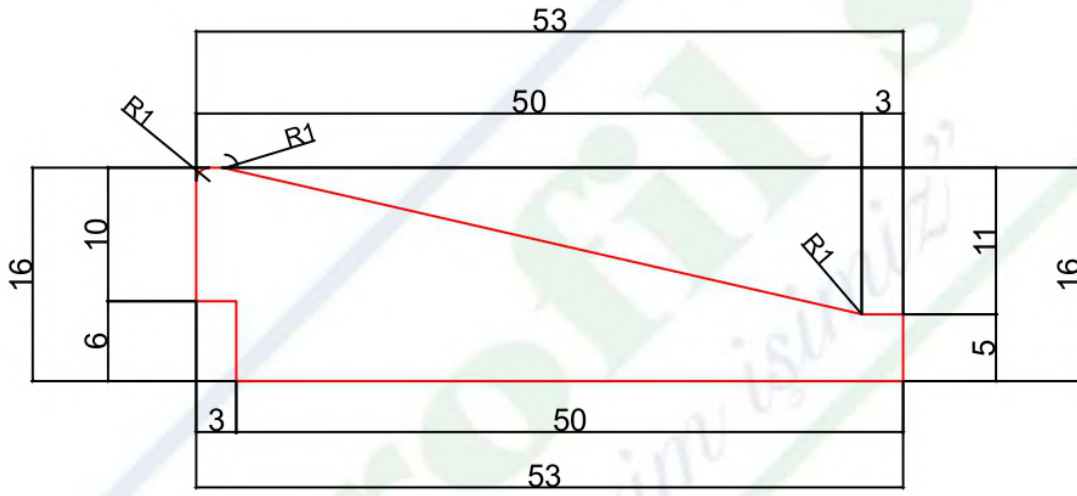

PVC BİTİŞ YERİ
(Pvc ending area)

BÖLÜM SORUMLUSU NEJDET ALTINTOPRAK	BU ÇİZİM PROFİLSE - SİLAS ORMAN ÜRÜNLERİ'NE AİTTİR. İZINSİZ ÇOĞALTILMAMAK VE KOPYA EDİLMEMEK ŞARTI İLE İZİN VERİLMİŞTİR.	PVC ENİ : MDF MİKTARI : PLAKADAN ÇIKAN :	KSM ÖLÇÜCÜ :	KUTU İÇİ : KUTU İÇİ ADET :
ARGE SORUMLUSU DOĞUKAN DEMİR	THIS DRAWING PROFILE - SİLAS FOREST PRODUCTS WHAT TO DO. UNLOCKED AND COPY NOT ALLOWED WITH THE WRITTEN.	GENEL TOLERANS : PROFİL BOY TOLERANSI :	MATERİYAL MM MDF	TARİH / DATE 20.12.2018

14-15-16 mm Profiles

PROFİLSE - SİLAS ORMAN ÜRÜNLERİ

KAĞIT ÜZERİNDEN ÖLÇÜ ALMAYINIZ !!!
Don't measurate on paper.

ÜRÜN KODU : 16*35
(Product Code)

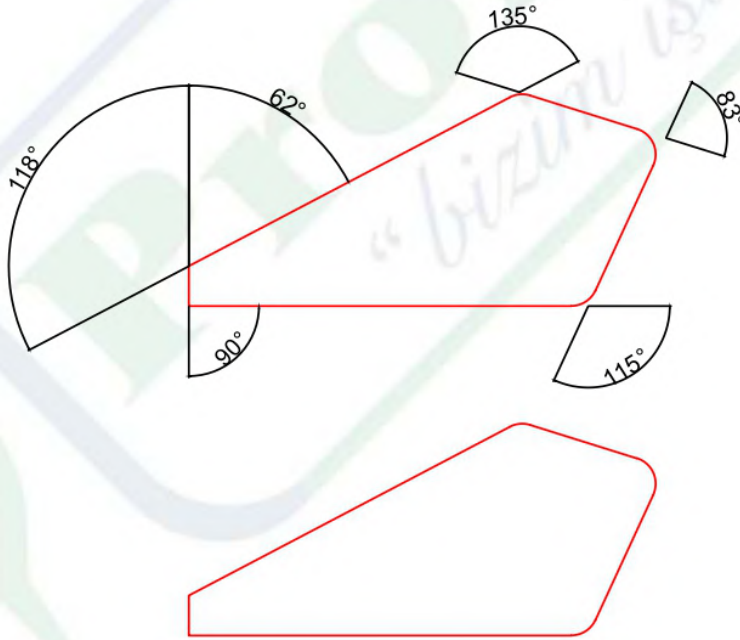
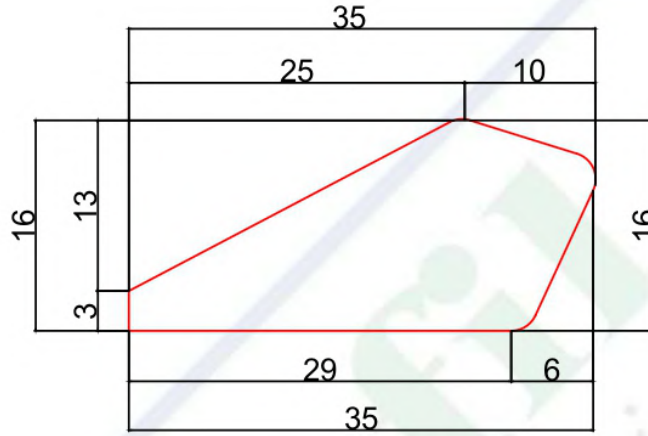

BÖLÜM SORUMLUSU NEJDET ALTINTOPRAK	BU ÇİZİM PROFİLSE - SİLAS ORMAN ÜRÜNLERİ'NE AİTTİR. İZINSİZ ÇOĞALTILMAMAK VE KOPYA EDİLMEMEK ŞARTI İLE İZİN VERİLMİŞTİR.	PVC ENİ : MDF MİKTARI : PLAKADAN ÇIKAN :	KSM ÖLÇÜCÜ :	KUTU İÇİ : KUTU İÇİ ADET :
ARGE SORUMLUSU DOĞUKAN DEMİR	THIS DRAWING PROFILE - SİLAS FOREST PRODUCTS WHAT TO DO. UNLOCKED AND COPY NOT ALLOWED WITH THE WRITTEN.	GENEL TOLERANS : PROFİL BOY TOLERANSI :	MATERİYAL MM MDF	TARİH / DATE 25.12.2018

14-15-16 mm Profiles

PROFİLSE - SİLAS ORMAN ÜRÜNLERİ

KAĞIT ÜZERİNDEN ÖLÇÜ ALMAYINIZ !!!

Don't measurate on paper.

ÜRÜN KODU : 16*50

(Product Code)

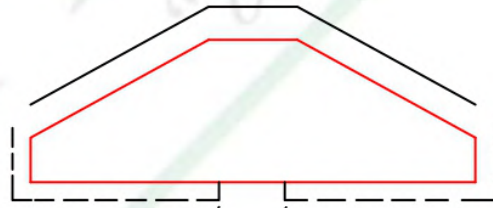
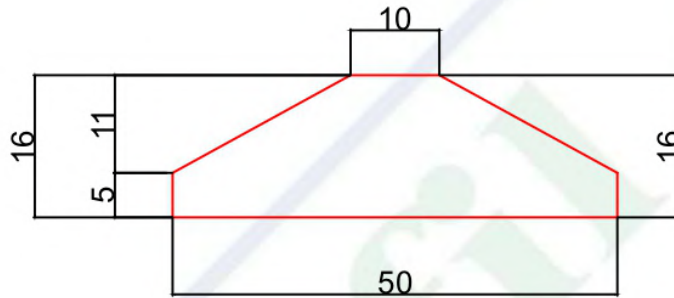

PVC BİTİŞ YERİ

(Pvc ending area)

BÖLÜM SORUMLUSU NEJDET ALTINTOPRAK	BU ÇİZİM PROFİLSE - SİLAS ORMAN ÜRÜNLERİ'NE AİTTİR. İZINSİZ ÇOĞALTILMAMAK VE KOPYA EDİLMEK ŞARTI İLE İZİN VERİLMİŞTİR.	PVC ENİ : MDF MİKTARI : PLAKADAN ÇIKAN :	KSM ÖLÇÜCÜ :	KUTU İÇİ : KUTU İÇİ ADET :
ARGE SORUMLUSU DOĞUKAN DEMİR	THIS DRAWING PROFILE - SİLAS FOREST PRODUCTS WHAT TO DO. UNLOCKED AND COPY NOT ALLOWED WITH THE WRITTEN.	GENEL TOLERANS : PROFİL BOY TOLERANSI :	MATERİYAL MM MDF	TARİH / DATE 10.10.2018

14-15-16 mm Profiles

PROFİLSE - SİLAS ORMAN ÜRÜNLERİ

KAĞIT ÜZERİNDEN ÖLÇÜ ALMAYINIZ !!!

Don't measure on paper.

ÜRÜN KODU : 16*18

(Product Code)

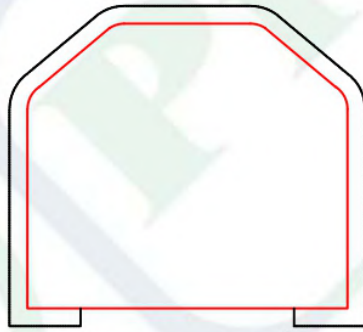
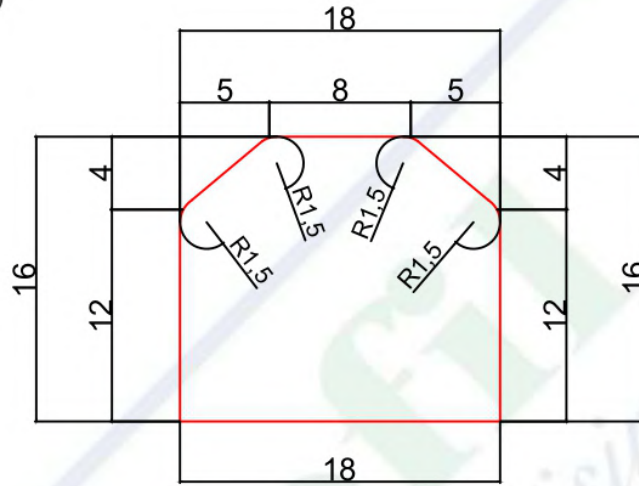

PVC BİTİŞ YERİ

(Pvc ending area)

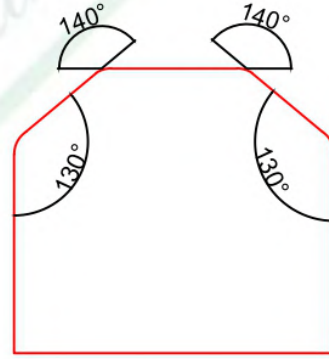

BÖLÜM SORUMLUSU NEJDET ALTINTOPRAK	BU ÇİZİM PROFİLSE - SİLAS ORMAN ÜRÜNLERİ NE AİTTİR. İZINSİZ ÇOĞALTILMAMAK VE KOPYA EDİLMEK ŞARTI İLE İZİN VERİLMİŞTİR.	PVC ENİ : MDF MİKTARI : PLAKADAN ÇIKAN :	KSM ÖLÇÜCÜ :	KUTU İÇİ : KUTU İÇİ ADET :
ARGE SORUMLUSU DOĞUKAN DEMİR	THIS DRAWING PROFILE - SİLAS FOREST PRODUCTS WHAT TO DO. UNLOCKED AND COPY NOT ALLOWED WITH THE WRITTEN.	GENEL TOLERANS : PROFİL BOY TOLERANSI :	MATERİYAL MM MDF	TARİH / DATE 4.01.2019

18 mm Profiles

PROFİLSE - SİLAS ORMAN ÜRÜNLERİ

KAĞIT ÜZERİNDEN ÖLÇÜ ALMAYINIZ !!!
Don't measure on paper.

ÜRÜN KODU : 18*45
(Product Code)

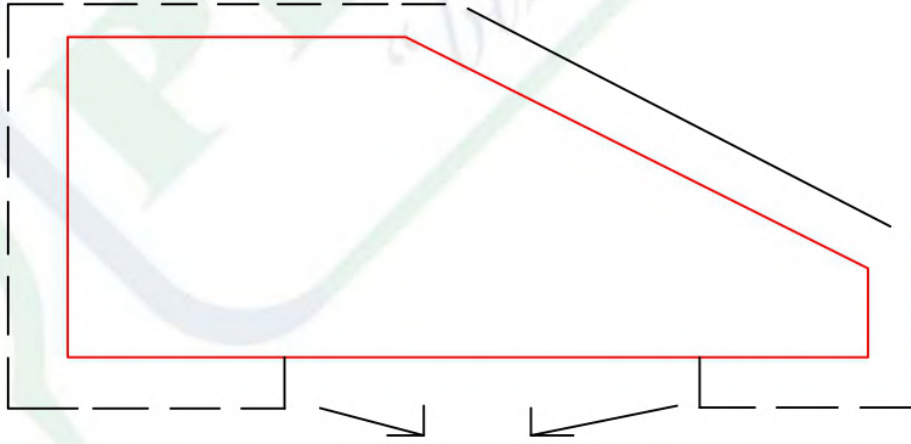
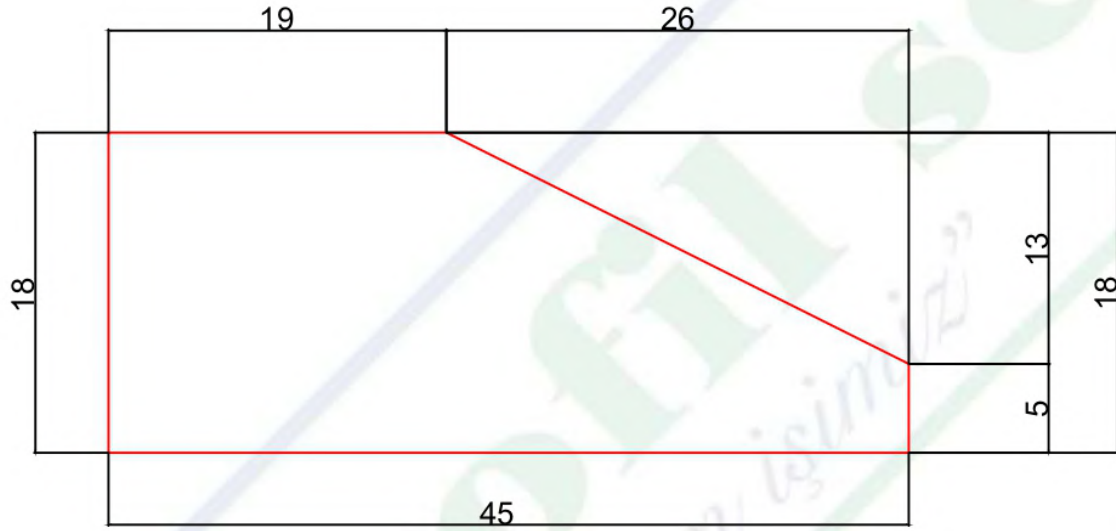

PVC BİTİŞ YERİ
(Pvc ending area)

BÖLÜM SORUMLUSU NEJDET ALTINTOPRAK	BU ÇİZİM PROFİLSE - SİLAS ORMAN ÜRÜNLERİ'NE AİTTİR. İZİNSİZ ÇOĞALTILMAMAK VE KOPYA EDİLMEK ŞARTI İLE İZİN VERİLMİŞTİR.	PVC ENİ : MDF MİKTARI : PLAKADAN ÇIKAN :	KSM ÖLÇÜCÜ :	KUTU İÇİ : KUTU İÇİ ADET :
ARGE SORUMLUSU DOĞUKAN DEMİR	THIS DRAWING PROFILE - SİLAS FOREST PRODUCTS WHAT TO DO. UNLOCKED AND COPY NOT ALLOWED WITH THE WRITTEN.	GENEL TOLERANS : PROFİL BOY TOLERANSI :	MATERİYAL MM MDF	TARİH / DATE 12.11.2018

18 mm Profiles

PROFİLSE - SİLAS ORMAN ÜRÜNLERİ

KAĞIT ÜZERİNDEN ÖLÇÜ ALMAYINIZ !!!

Don't measurate on paper.

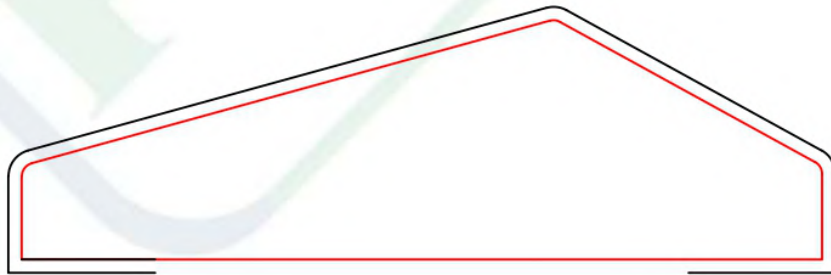
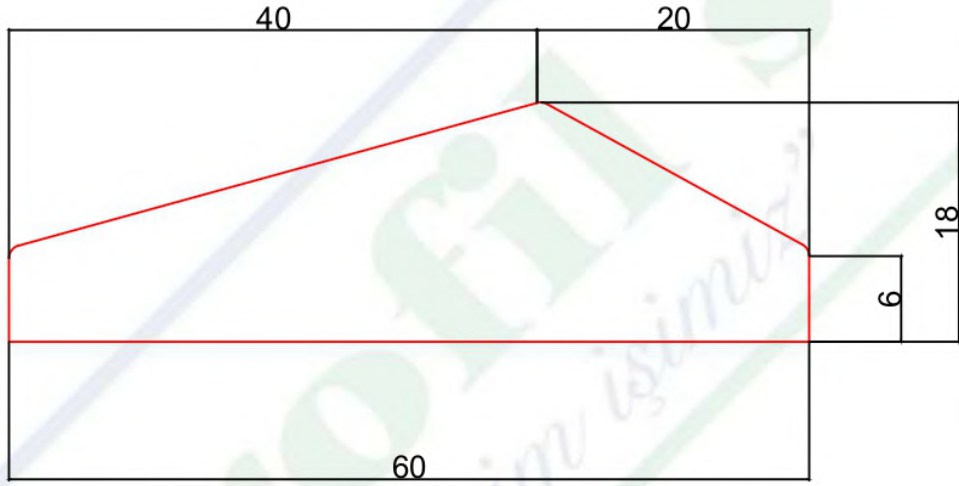

BÖLÜM SORUMLUSU NEJDET ALTINTOPRAK	BU ÇİZİM PROFİLSE - SİLAS ORMAN ÜRÜNLERİ'NE AİTTİR. İZINSİZ ÇOĞALTILMAMAK VE KOPYA EDİLMEMEK ŞARTI İLE İZİN VERİLMİŞTİR.	PVC ENİ : MDF MİKTARI : PLAKADAN ÇIKAN :	KSM ÖLÇÜCÜ :	KUTU İÇİ : KUTU İÇİ ADET :
ARGE SORUMLUSU DOĞUKAN DEMİR	THIS DRAWING PROFILE - SİLAS FOREST PRODUCTS WHAT TO DO. UNLOCKED AND COPY NOT ALLOWED WITH THE WRITTEN.	GENEL TOLERANS : PROFİL BOY TOLERANSI :	MATERİYAL MM MDF	TARİH / DATE 20.09.2018

18 mm Profiles

PROFİLSE - SİLAS ORMAN ÜRÜNLERİ

KAĞIT ÜZERİNDEN ÖLÇÜ ALMAYINIZ !!!

Don't measurate on paper.

ÜRÜN KODU : 18*25
(Product Code)

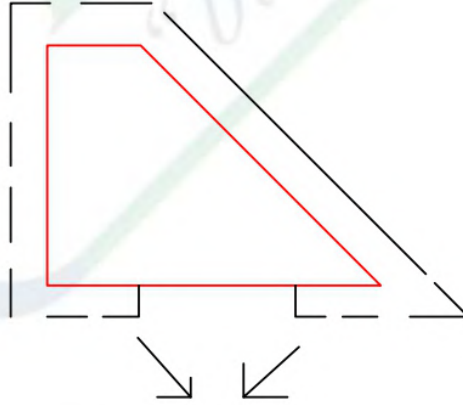
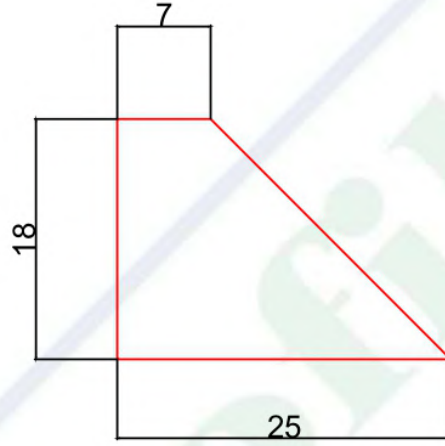

PVC BİTİŞ YERİ
(Pvc ending area)

BÖLÜM SORUMLUSU NEJDET ALTINTOPRAK	BU ÇİZİM PROFİLSE - SİLAS ORMAN ÜRÜNLERİ'NE AİTTİR. İZINSİZ ÇOĞALTILMAMAK VE KOPYA EDİLMEMEK ŞARTI İLE İZİN VERİLMİŞTİR.	PVC ENİ : MDF MİKTARI : PLAKADAN ÇIKAN :	KSM ÖLÇÜCÜ :	KUTU İÇİ : KUTU İÇİ ADET :
ARGE SORUMLUSU DOĞUKAN DEMİR	THIS DRAWING PROFILE - SİLAS FOREST PRODUCTS WHAT TO DO. UNLOCKED AND COPY NOT ALLOWED WITH THE WRITTEN.	GENEL TOLERANS : PROFL BOY TOLERANSI :	MATERİYAL MM MDF	TARİH / DATE 10.09.2018

18 mm Profiles

PROFİLSE - SİLAS ORMAN ÜRÜNLERİ

KAĞIT ÜZERİNDEN ÖLÇÜ ALMAYINIZ !!!

ÜRÜN KODU : 18*40

Don't measurate on paper.

(Product Code)

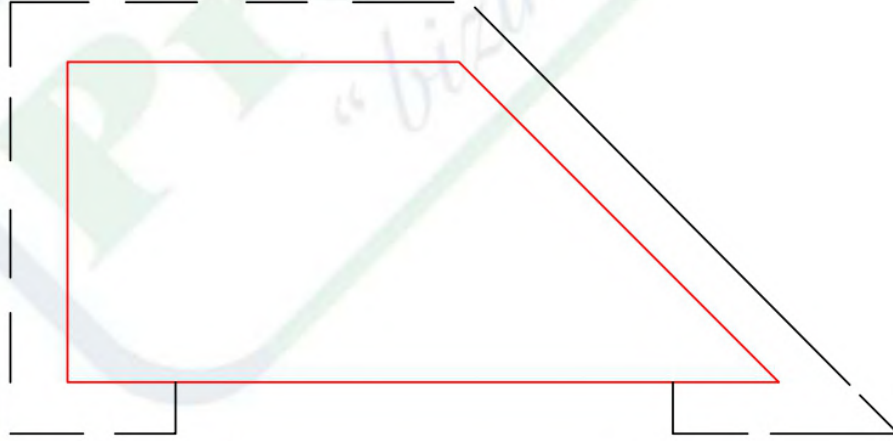
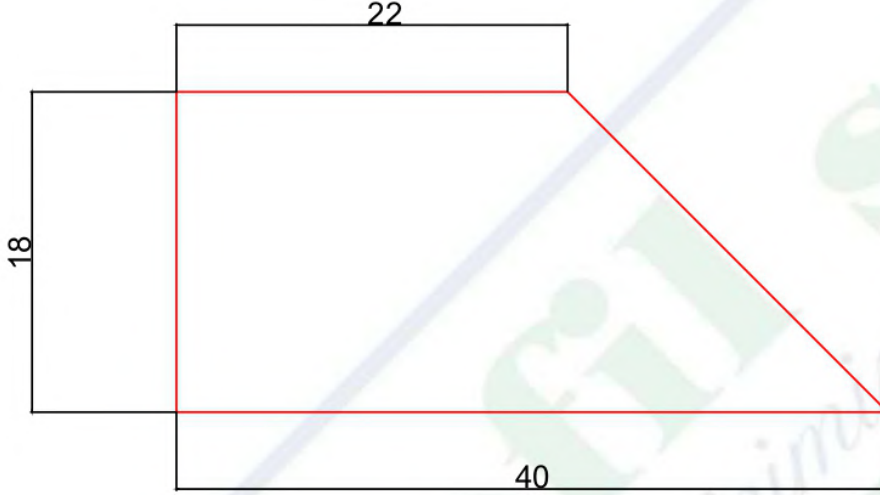

PVC BİTİŞ YERİ
(Pvc ending area)

BÖLÜM SORUMLUSU NEJDET ALTINTOPRAK	BU ÇİZİM PROFİLSE - SİLAS ORMAN ÜRÜNLERİ'NE AİTTİR. İZİNSİZ ÇOĞALTILMAMAK VE KOPYA EDİLMEK ŞARTI İLE İZİN VERİLMİŞTİR.	PVC ENİ : MDF MİKTARI : PLAKADAN ÇIKAN :	KSM ÖLÇÜCÜ :	KUTU İÇİ : KUTU İÇİ ADET :
ARGE SORUMLUSU DOĞUKAN DEMİR	THIS DRAWING PROFILE - SİLAS FOREST PRODUCTS WHAT TO DO. UNLOCKED AND COPY NOT ALLOWED WITH THE WRITTEN.	GENEL TOLERANS : PROFİL BOY TOLERANSI :	MATERİYAL MM MDF	TARİH / DATE 10.09.2018

18 mm Profiles

PROFİLSE - SİLAS ORMAN ÜRÜNLERİ

KAĞIT ÜZERİNDEN ÖLÇÜ ALMAYINIZ !!!

Don't measurate on paper.

ÜRÜN KODU : 18*28

(Product Code)

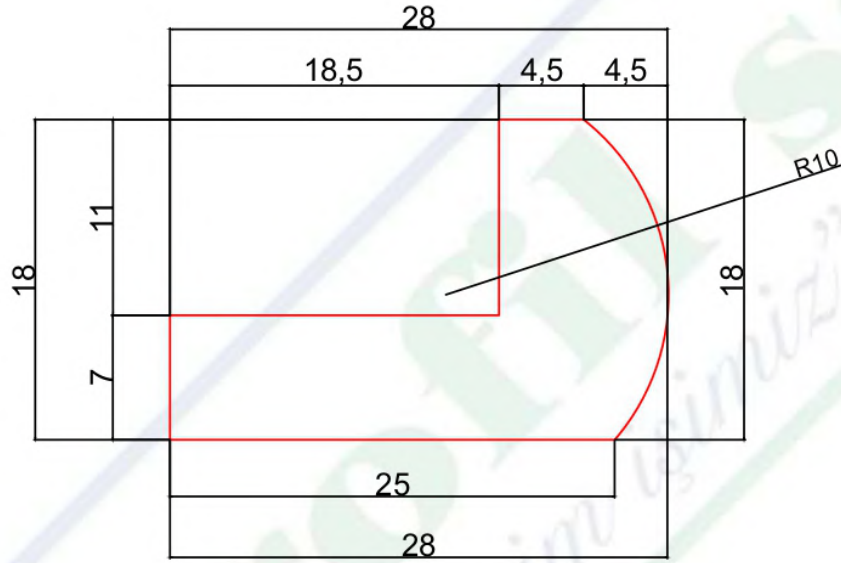

(Pvc ending area)
PVC BİTİŞ YERİ

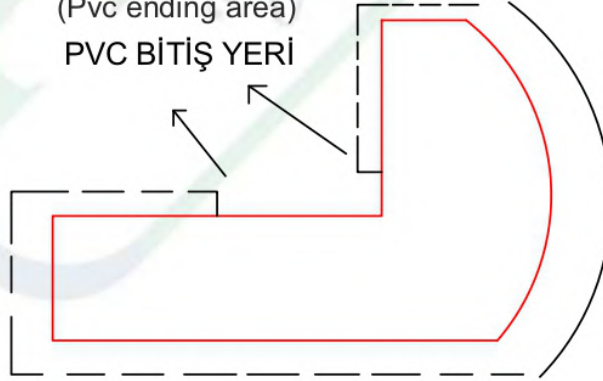

BÖLÜM SORUMLUSU NEJDET ALTINTOPRAK	BU ÇİZİM PROFİLSE - SİLAS ORMAN ÜRÜNLERİ'NE AİTTİR. İZINSİZ ÇOĞALTILMAMAK VE KOPYA EDİLMEKEMEK ŞARTI İLE İZİN VERİLMİŞTİR.	PVC ENİ : MDF MİKTARI : PLAKADAN ÇIKAN :	KSM ÖLÇÜCÜ :	KUTU İÇİ : KUTU İÇİ ADET :
ARGE SORUMLUSU DOĞUKAN DEMİR	THIS DRAWING PROFILE - SİLAS FOREST PRODUCTS WHAT TO DO. UNLOCKED AND COPY NOT ALLOWED WITH THE WRITTEN.	GENEL TOLERANS : PROFL BOY TOLERANSI :	MATERİAL MM MDF	TARİH / DATE 10.10.2018

18 mm Profiles

PROFİLSE - SİLAS ORMAN ÜRÜNLERİ

KAĞIT ÜZERİNDEN ÖLÇÜ ALMAYINIZ !!!

Don't measurate on paper.

ÜRÜN KODU : 18*30

(Product Code)

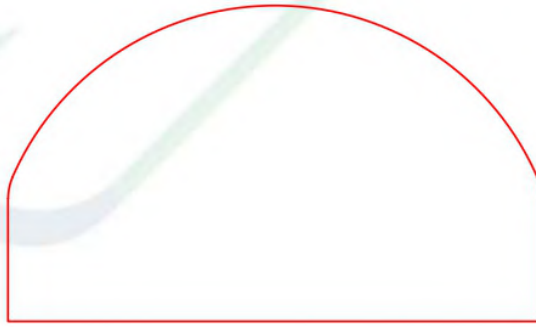
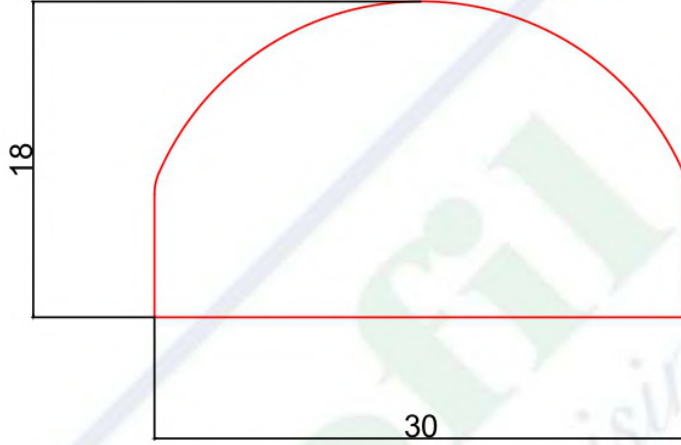

BÖLÜM SORUMLUSU NEJDET ALTINTOPRAK	BU ÇİZİM PROFİLSE - SİLAS ORMAN ÜRÜNLERİ'NE AİTTİR. İZINSİZ ÇOĞALTILMAMAK VE KOPYA EDİLMEK ŞARTI İLE İZİN VERİLMİŞTİR.	PVC ENİ : MDF MİKTARI : PLAKADAN ÇIKAN :	KSM ÖLÇÜCÜ :	KUTU İÇİ : KUTU İÇİ ADET :
ARGE SORUMLUSU DOĞUKAN DEMİR	THIS DRAWING PROFILE - SİLAS FOREST PRODUCTS WHAT TO DO. UNLOCKED AND COPY NOT ALLOWED WITH THE WRITTEN.	GENEL TOLERANS : PROFİL BOY TOLERANSI :	MATERİYAL MM MDF	TARİH / DATE 17.10.2018

18 mm Profiles

PROFİLSE - SİLAS ORMAN ÜRÜNLERİ

KAĞIT ÜZERİNDEN ÖLÇÜ ALMAYINIZ !!!

ÜRÜN KODU : 18*18

Don't measurate on paper.

(Product Code)

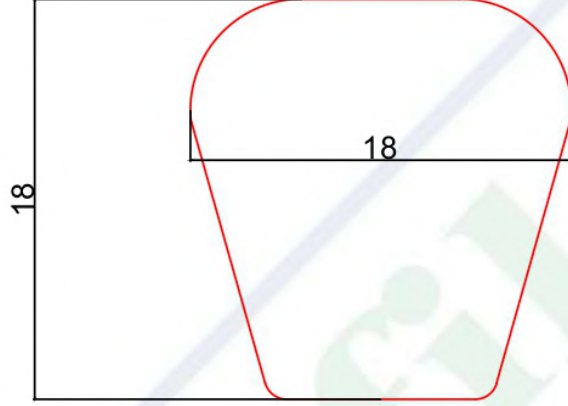

BÖLÜM SORUMLUSU NEJDET ALTINTOPRAK	BU ÇİZİM PROFİLSE - SİLAS ORMAN ÜRÜNLERİ'NE AİTTİR. İZİNSİZ ÇOĞALTILMAMAK VE KOPYA EDİLMEKEMEK ŞARTI İLE İZİN VERİLMİŞTİR.	PVC ENİ : MDF MİKTARI : PLAKADAN ÇIKAN :	KSM ÖLÇÜCÜ :	KUTU İÇİ : KUTU İÇİ ADET :
ARGE SORUMLUSU DOĞUKAN DEMİR	THIS DRAWING PROFILE - SİLAS FOREST PRODUCTS WHAT TO DO. UNLOCKED AND COPY NOT ALLOWED WITH THE WRITTEN.	GENEL TOLERANS : PROFİL BOY TOLERANSI :	MATERIAL MM MDF	TARİH / DATE 17.10.2018

18 mm Profiles

PROFİLSE - SİLAS ORMAN ÜRÜNLERİ

KAĞIT ÜZERİNDEN ÖLÇÜ ALMAYINIZ !!!

ÜRÜN KODU : 18*25-05

Don't measurate on paper.

(Product Code)

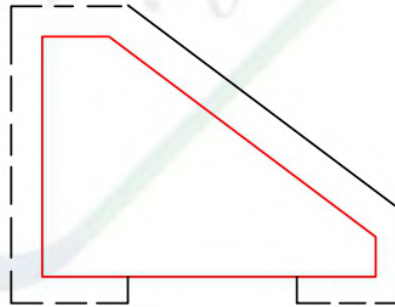
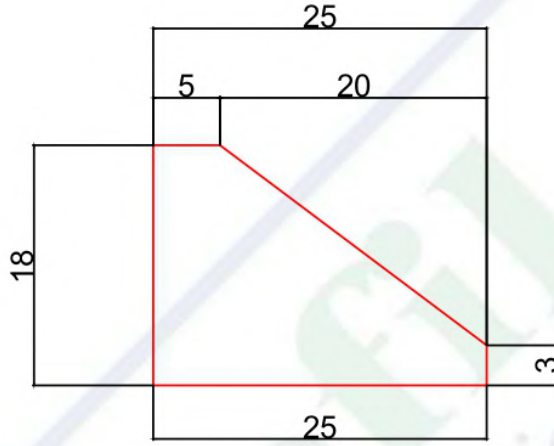

PVC BİTİŞ YERİ

(Pvc ending area)

BÖLÜM SORUMLUSU NEJDET ALTINTOPRAK	BU ÇİZİM PROFİLSE - SİLAS ORMAN ÜRÜNLERİ'NE AİTTİR. İZİNSİZ ÇOĞALTILMAMAK VE KOPYA EDİLMEKEMEK ŞARTI İLE İZİN VERİLMİŞTİR.	PVC ENİ : MDF MİKTARI : PLAKADAN ÇIKAN :	KSM ÖLÇÜCÜ :	KUTU İÇİ : KUTU İÇİ ADET :
ARGE SORUMLUSU DOĞUKAN DEMİR	THIS DRAWING PROFILE - SİLAS FOREST PRODUCTS WHAT TO DO. UNLOCKED AND COPY NOT ALLOWED WITH THE WRITTEN.	GENEL TOLERANS : PROFİL BOY TOLERANSI :	MATERİYAL MM MDF	TARİH / DATE 12.10.2018

18 mm Profiles

PROFİLSE - SİLAS ORMAN ÜRÜNLERİ

KAĞIT ÜZERİNDEN ÖLÇÜ ALMAYINIZ !!!

ÜRÜN KODU : 18*23

Don't measurate on paper.

(Product Code)

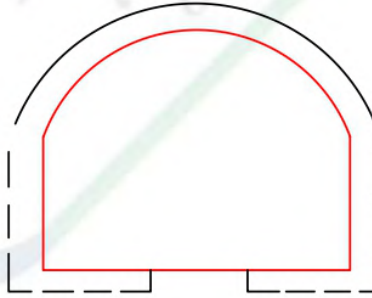
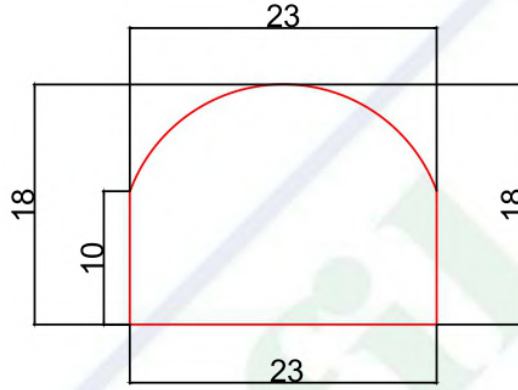

PVC BİTİŞ YERİ

(Pvc ending area)

BÖLÜM SORUMLUSU NEJDET ALTINTOPRAK	BU ÇİZİM PROFİLSE - SİLAS ORMAN ÜRÜNLERİ'NE AİTTİR. İZINSİZ ÇOĞALTILMAMAK VE KOPYA EDİLMEK ŞARTI İLE İZİN VERİLMİŞTİR.	PVC ENİ : MDF MİKTARI : PLAKADAN ÇIKAN :	KSM ÖLÇÜCÜ :	KUTU İÇİ : KUTU İÇİ ADET :
ARGE SORUMLUSU DOĞUKAN DEMİR	THIS DRAWING PROFILE - SİLAS FOREST PRODUCTS WHAT TO DO. UNLOCKED AND COPY NOT ALLOWED WITH THE WRITTEN.	GENEL TOLERANS : PROFİL BOY TOLERANSI :	MATERIAL MM MDF	TARİH / DATE 12.10.2018

18 mm Profiles

PROFİLSE - SİLAS ORMAN ÜRÜNLERİ

KAĞIT ÜZERİNDEN ÖLÇÜ ALMAYINIZ !!!

Don't measurate on paper.

ÜRÜN KODU : 18*70
(Product Code)

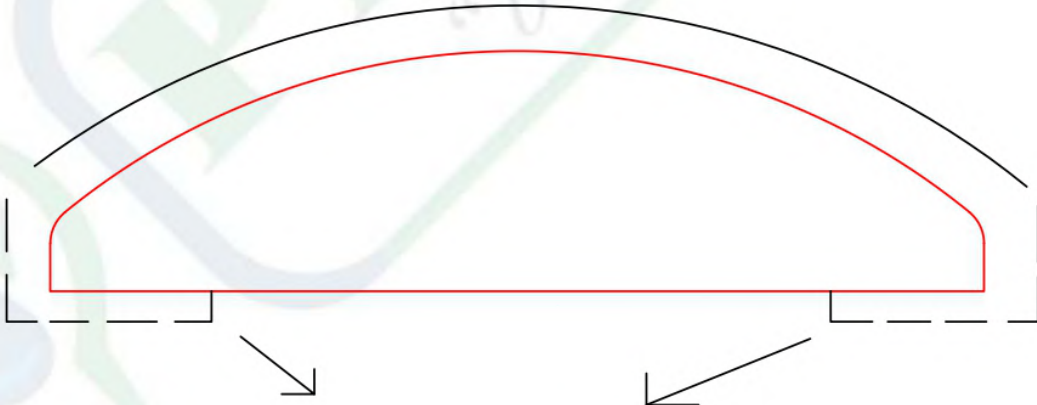
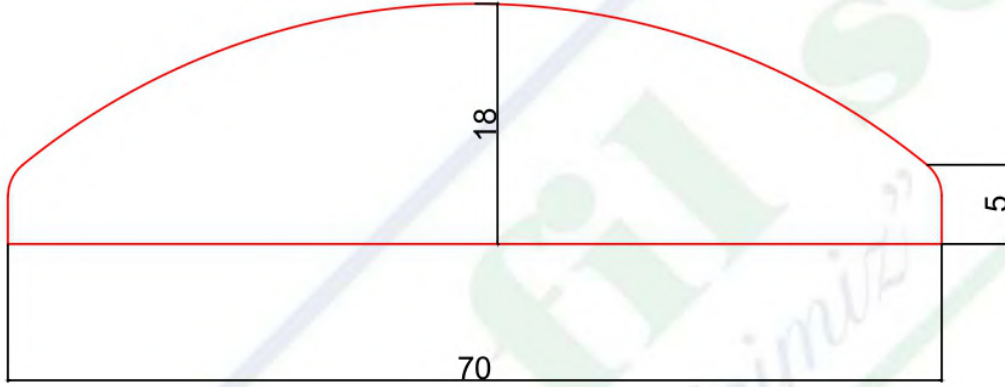

PVC BİTİŞ YERİ
(Pvc ending area)

BÖLÜM SORUMLUSU NEJDET ALTINTOPRAK	BU ÇİZİM PROFİLSE - SİLAS ORMAN ÜRÜNLERİ'NE AİTTİR. İZINSİZ ÇOĞALTILMAMAK VE KOPYA EDİLMEMEK ŞARTI İLE İZİN VERİLMİŞTİR.	PVC ENİ : MDF MİKTARI : PLAKADAN ÇIKAN :	KSM ÖLÇÜCÜ :	KUTU İÇİ : KUTU İÇİ ADET :
ARGE SORUMLUSU DOĞUKAN DEMİR	THIS DRAWING PROFILE - SİLAS FOREST PRODUCTS WHAT TO DO. UNLOCKED AND COPY NOT ALLOWED WITH THE WRITTEN.	GENEL TOLERANS : PROFİL BOY TOLERANSI :	MATERİYAL MM MDF	TARİH / DATE 11.10.2018

18 mm Profiles

PROFİLSE - SİLAS ORMAN ÜRÜNLERİ

KAĞIT ÜZERİNDEN ÖLÇÜ ALMAYINIZ !!!

ÜRÜN KODU : 18*70-02
(Product Code)

Don't measurate on paper.

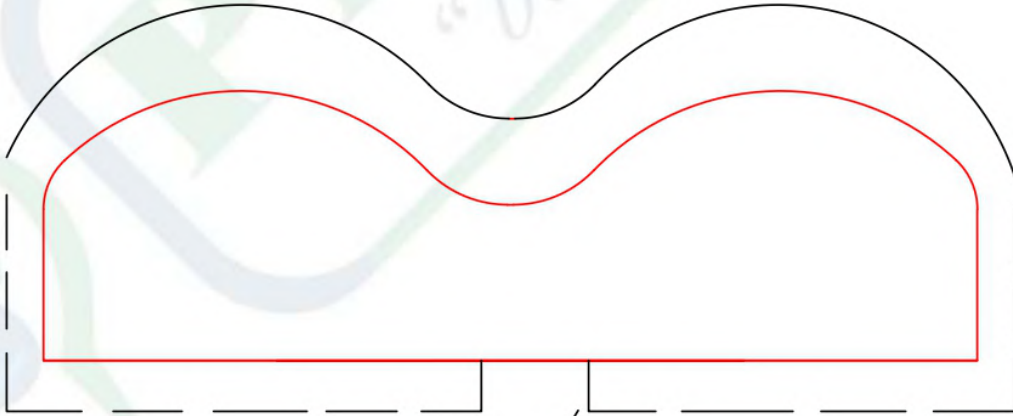
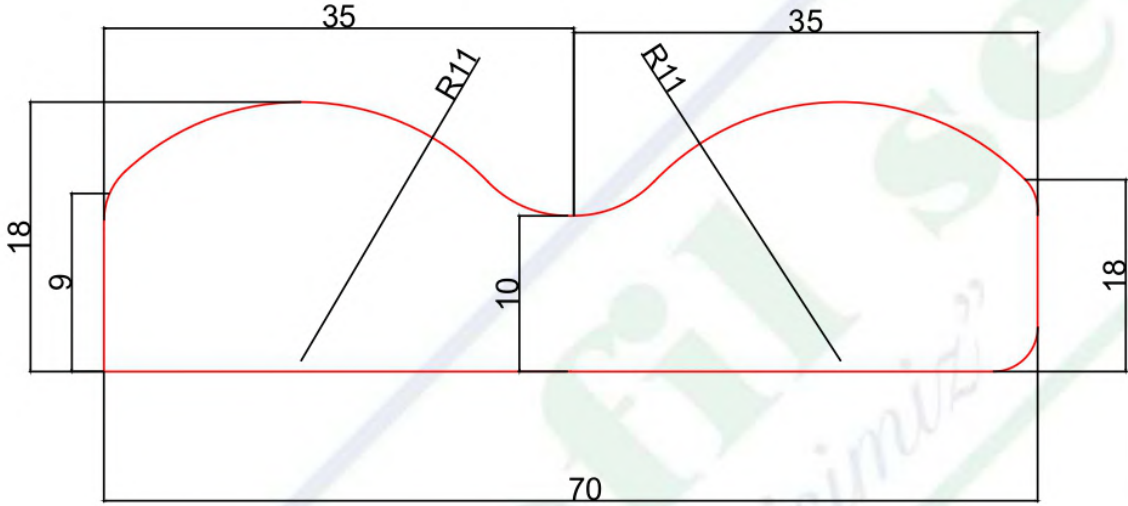

PVC BİTİŞ YERİ
(Pvc ending area)

BÖLÜM SORUMLUSU NEJDET ALTINTOPRAK	BU ÇİZİM PROFİLSE - SİLAS ORMAN ÜRÜNLERİ'NE AİTTİR. İZİNSİZ ÇOĞALTILMAMAK VE KOPYA EDİLMEK ŞARTI İLE İZİN VERİLMİŞTİR.	PVC ENİ : MDF MİKTARI : PLAKADAN ÇIKAN :	KSM ÖLÇÜCÜ :	KUTU İÇİ : KUTU İÇİ ADET :
ARGE SORUMLUSU DOĞUKAN DEMİR	THIS DRAWING PROFILE - SİLAS FOREST PRODUCTS WHAT TO DO. UNLOCKED AND COPY NOT ALLOWED WITH THE WRITTEN.	GENEL TOLERANS : PROFİL BOY TOLERANSI :	MATERİYAL MM MDF	TARİH / DATE 12.10.2018

18 mm Profiles

PROFİLSE - SİLAS ORMAN ÜRÜNLERİ

KAĞIT ÜZERİNDEN ÖLÇÜ ALMAYINIZ !!!
Don't measurate on paper.

ÜRÜN KODU : 18*22
(Product Code)

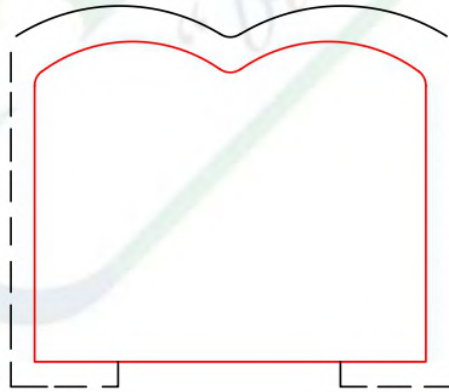
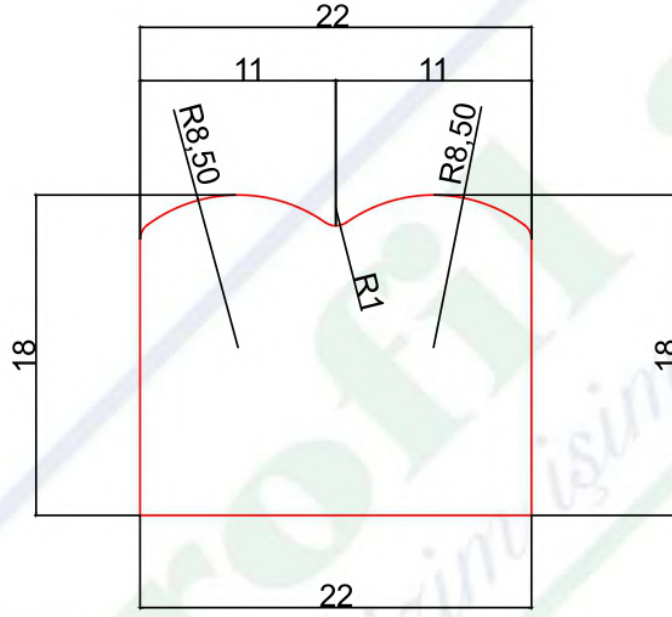

PVC BİTİŞ YERİ
(Pvc ending area)

BÖLÜM SORUMLUSU NEJDET ALTINTOPRAK	BU ÇİZİM PROFİLSE - SİLAS ORMAN ÜRÜNLERİ'NE AİTTİR. İZİNSİZ ÇOĞALTILMAMAK VE KOPYA EDİLMEMEK ŞARTI İLE İZİN VERİLMİŞTİR.	PVC ENİ : MDF MİKTARI : PLAKADAN ÇIKAN :	KSM ÖLÇÜCÜ :	KUTU İÇİ : KUTU İÇİ ADET :
ARGE SORUMLUSU DOĞUKAN DEMİR	THIS DRAWING PROFILE - SİLAS FOREST PRODUCTS WHAT TO DO. UNLOCKED AND COPY NOT ALLOWED WITH THE WRITTEN.	GENEL TOLERANS : PROFL BOY TOLERANSI :	MATERIAL MM MDF	TARİH / DATE 19.11.2018

18 mm Profiles

PROFİLSE - SİLAS ORMAN ÜRÜNLERİ

ÜRÜN KODU : 18*33
(Product Code)

KAĞIT ÜZERİNDEN ÖLÇÜ ALMAYINIZ !!!
Don't measure on paper.

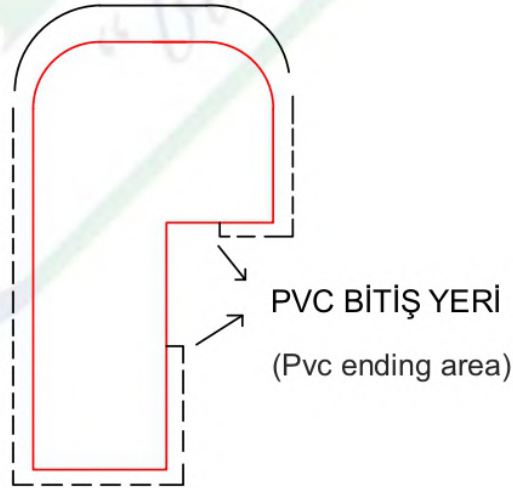
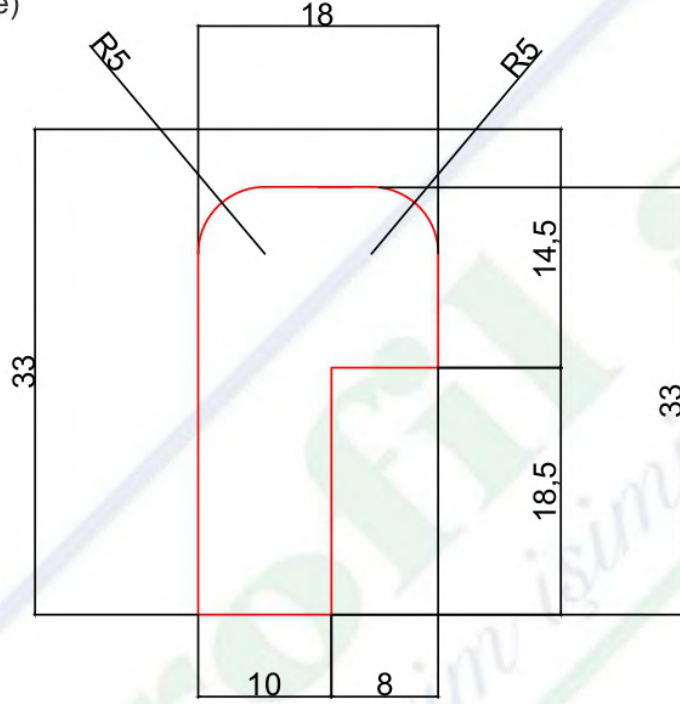

BÖLÜM SORUMLUSU NEJDET ALTINTOPRAK	BU ÇİZİM PROFİLSE - SİLAS ORMAN ÜRÜNLERİ'NE AİTTİR. İZINSİZ ÇOĞALTILMAMAK VE KOPYA EDİLMEMEK ŞARTI İLE İZİN VERİLMİŞTİR.	PVC ENİ : MDF MİKTARI : PLAKADAN ÇIKAN :	KSM ÖLÇÜCÜ :	KUTU İÇİ : KUTU İÇİ ADET :
ARGE SORUMLUSU DOĞUKAN DEMİR	THIS DRAWING PROFILE - SİLAS FOREST PRODUCTS WHAT TO DO. UNLOCKED AND COPY NOT ALLOWED WITH THE WRITTEN.	GENEL TOLERANS : PROFİL BOY TOLERANSI :	MATERİYAL MM MDF	TARİH / DATE 19.11.2018

18 mm Profiles

PROFİLSE - SİLAS ORMAN ÜRÜNLERİ

KAĞIT ÜZERİNDEN ÖLÇÜ ALMAYINIZ !!!
Don't measurate on paper.

ÜRÜN KODU : 18*80-01
(Product Code)

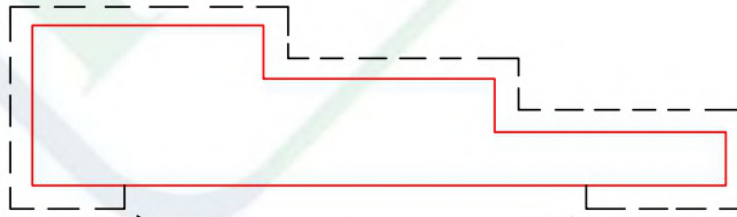
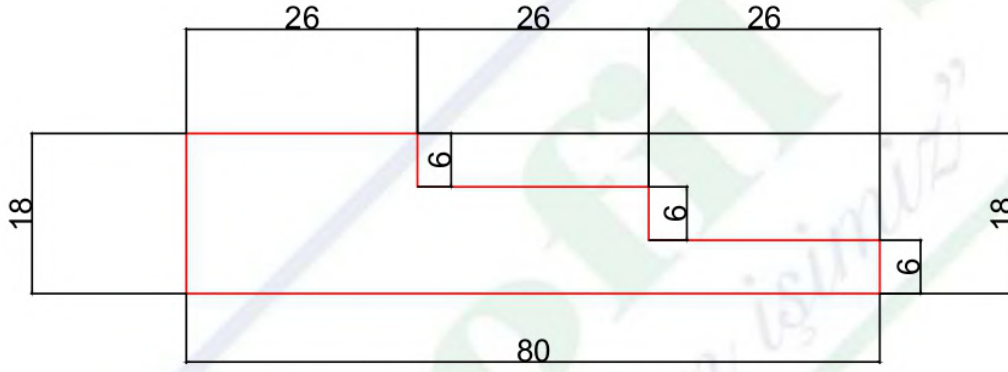

PVC BİTİŞ YERİ
(Pvc ending area)

BÖLÜM SORUMLUSU NEJDET ALTINTOPRAK	BU ÇİZİM PROFİLSE - SİLAS ORMAN ÜRÜNLERİ'NE AİTTİR. İZİNSİZ ÇOĞALTILMAMAK VE KOPYA EDİLMEMEK ŞARTI İLE İZİN VERİLMİŞTİR.	PVC ENİ : MDF MİKTARI : PLAKADAN ÇIKAN :	KSM ÖLÇÜCÜ :	KUTU İÇİ : KUTU İÇİ ADET :
ARGE SORUMLUSU DOĞUKAN DEMİR	THIS DRAWING PROFILE - SİLAS FOREST PRODUCTS WHAT TO DO. UNLOCKED AND COPY NOT ALLOWED WITH THE WRITTEN.	GENEL TOLERANS : PROFL BOY TOLERANSI :	MATERİYAL MM MDF	TARİH / DATE 19.11.2018

18 mm Profiles

PROFİLSE - SİLAS ORMAN ÜRÜNLERİ

KAĞIT ÜZERİNDEN ÖLÇÜ ALMAYINIZ !!!
Don't measure on paper.

ÜRÜN KODU : 18*55
(Product Code)

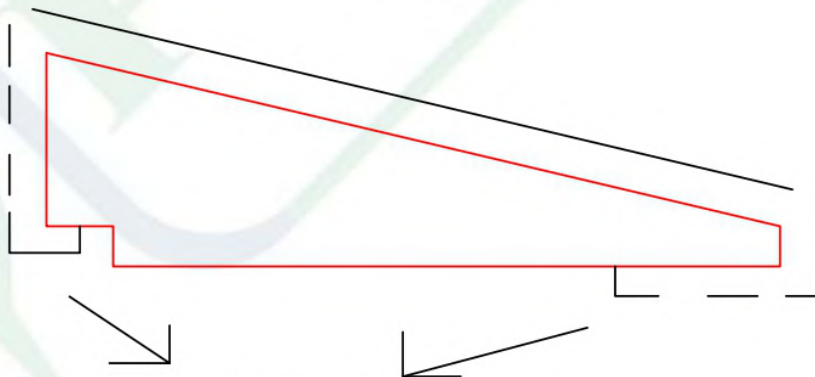
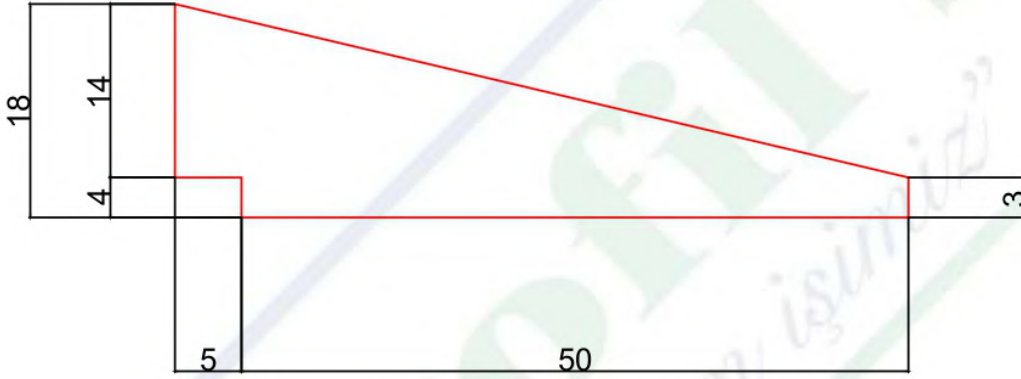

PVC BİTİŞ YERİ

(Pvc ending area)

BÖLÜM SORUMLUSU NEJDET ALTINTOPRAK	BU ÇİZİM PROFİLSE - SİLAS ORMAN ÜRÜNLERİ'NE AİTTİR. İZINSİZ ÇOĞALTILMAMAK VE KOPYA EDİLMEKEMEK ŞARTI İLE İZİN VERİLMİŞTİR.	PVC ENİ : MDF MİKTARI : PLAKADAN ÇIKAN :	KSM ÖLÇÜCÜ :	KUTU İÇİ : KUTU İÇİ ADET :
ARGE SORUMLUSU DOĞUKAN DEMİR	THIS DRAWING PROFILE - SİLAS FOREST PRODUCTS WHAT TO DO. UNLOCKED AND COPY NOT ALLOWED WITH THE WRITTEN.	GENEL TOLERANS : PROFL BOY TOLERANSI :	MATERİYAL MM MDF	TARİH / DATE 04.10.2018

18 mm Profiles

PROFİLSE - SİLAS ORMAN ÜRÜNLERİ

KAĞIT ÜZERİNDEN ÖLÇÜ ALMAYINIZ !!!

Don't measurate on paper.

ÜRÜN KODU : 18*18

(Product Code)

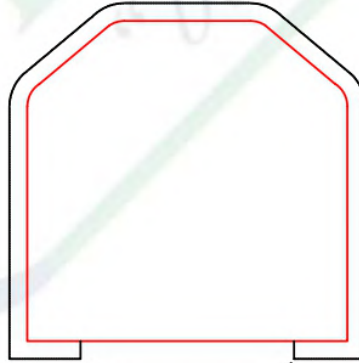
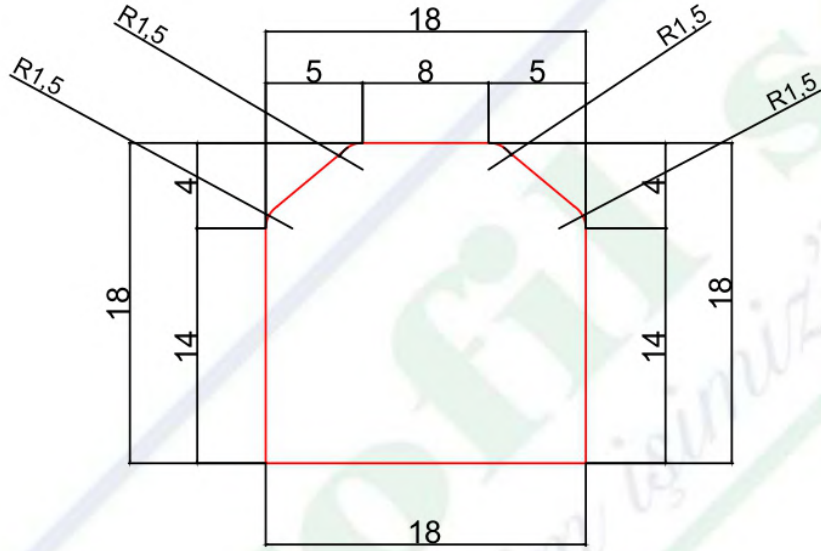

PVC BİTİŞ YERİ

(Pvc ending area)

BÖLÜM SORUMLUSU NEJDET ALTINTOPRAK	BU ÇİZİM PROFİLSE - SİLAS ORMAN ÜRÜNLERİ'NE AİTTİR. İZİNSİZ ÇOĞALTILMAMAK VE KOPYA EDİLMEKEMEK ŞARTI İLE İZİN VERİLMİŞTİR.	PVC ENİ : MDF MİKTARI : PLAKADAN ÇIKAN :	KSM ÖLÇÜCÜ :	KUTU İÇİ : KUTU İÇİ ADET :
ARGE SORUMLUSU DOĞUKAN DEMİR	THIS DRAWING PROFILE - SİLAS FOREST PRODUCTS WHAT TO DO. UNLOCKED AND COPY NOT ALLOWED WITH THE WRITTEN.	GENEL TOLERANS : PROFL BOY TOLERANSI :	MATERİAL MM MDF	TARİH / DATE 20.12.2018

18 mm Profiles

PROFİLSE - SİLAS ORMAN ÜRÜNLERİ

KAĞIT ÜZERİNDEN ÖLÇÜ ALMAYINIZ !!!

Don't measurate on paper.

ÜRÜN KODU : 18*25

(Product Code)

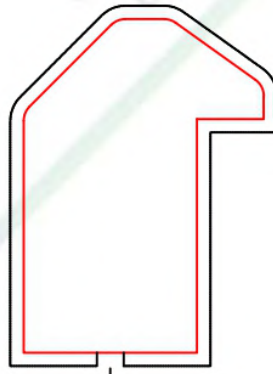
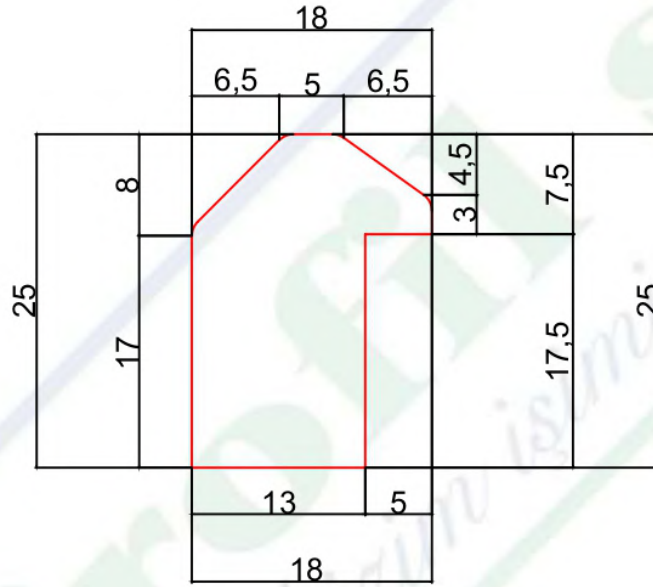

PVC BİTİŞ YERİ
(Pvc ending area)

BÖLÜM SORUMLUSU NEJDET ALTINTOPRAK	BU ÇİZİM PROFİLSE - SİLAS ORMAN ÜRÜNLERİ'NE AİTTİR. İZİNSİZ ÇOĞALTILMAMAK VE KOPYA EDİLMEMEK ŞARTI İLE İZİN VERİLMİŞTİR.	PVC ENİ : MDF MİKTARI : PLAKADAN ÇIKAN :	KSM ÖLÇÜCÜ :	KUTU İÇİ : KUTU İÇİ ADET :
ARGE SORUMLUSU DOĞUKAN DEMİR	THIS DRAWING PROFILE - SİLAS FOREST PRODUCTS WHAT TO DO. UNLOCKED AND COPY NOT ALLOWED WITH THE WRITTEN.	GENEL TOLERANS : PROFİL BOY TOLERANSI :	MATERİYAL MM MDF	TARİH / DATE 20.12.2018

18 mm Profiles

PROFİLSE - SİLAS ORMAN ÜRÜNLERİ

KAĞIT ÜZERİNDEN ÖLÇÜ ALMAYINIZ !!!
Don't measurate on paper.

ÜRÜN KODU: 18*25
(Product Code)

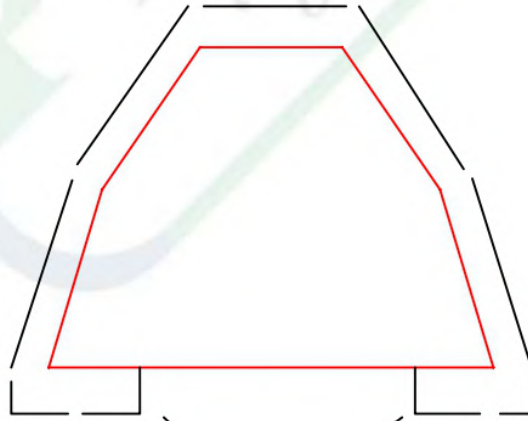
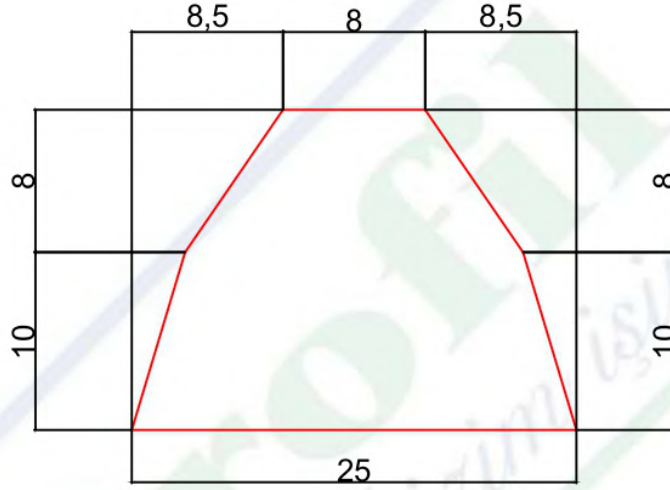

PVC BİTİŞ YERİ
(Pvc ending area)

BÖLÜM SORUMLUSU NEJDET ALTINTOPRAK	BU ÇİZİM PROFİLSE - SİLAS ORMAN ÜRÜNLERİ'NE AİTTİR. İZİNSİZ ÇOĞALTILMAMAK VE KOPYA EDİLMEMEK ŞARTI İLE İZİN VERİLMİŞTİR.	PVC ENİ : MDF MİKTARI : PLAKADAN ÇIKAN :	KSM ÖLÇÜCÜ :	KUTU İÇİ : KUTU İÇİ ADET :
ARGE SORUMLUSU DOĞUKAN DEMİR	THIS DRAWING PROFILE - SİLAS FOREST PRODUCTS WHAT TO DO. UNLOCKED AND COPY NOT ALLOWED WITH THE WRITTEN.	GENEL TOLERANS : PROFİL BOY TOLERANSI :	MATERİYAL MM MDF	TARİH / DATE 03.12.2018

18 mm Profiles

PROFİLSE - SİLAS ORMAN ÜRÜNLERİ

KAĞIT ÜZERİNDEN ÖLÇÜ ALMAYINIZ !!!
Don't measure on paper.

ÜRÜN KODU: 18*40
(Product Code)

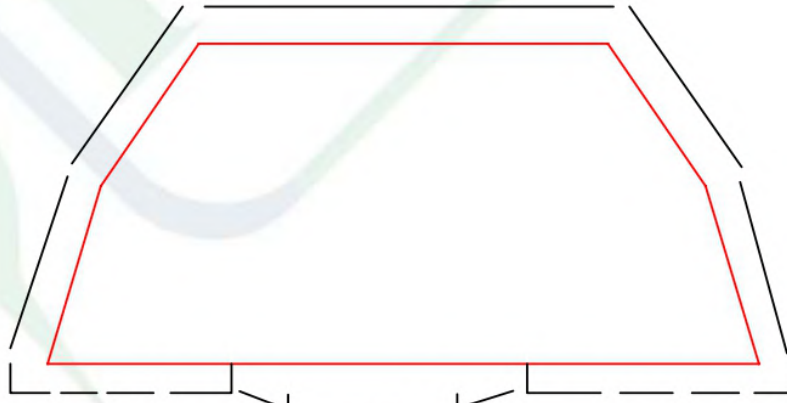
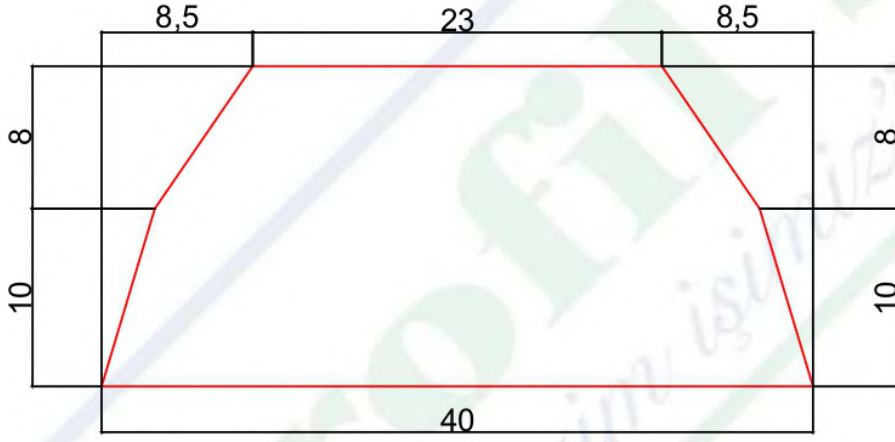

PVC BİTİŞ YERİ (Pvc ending area)

BÖLÜM SORUMLUSU NEJDET ALTINTOPRAK	BU ÇİZİM PROFİLSE - SİLAS ORMAN ÜRÜNLERİ'NE AİTTİR. İZINSİZ ÇOĞALTILMAMAK VE KOPYA EDİLMEMEK ŞARTI İLE İZİN VERİLMİŞTİR.	PVC ENİ : MDF MİKTARI : PLAKADAN ÇIKAN :	KSM ÖLÇÜCÜ :	KUTU İÇİ : KUTU İÇİ ADET :
ARGE SORUMLUSU DOĞUKAN DEMİR	THIS DRAWING PROFILE - SİLAS FOREST PRODUCTS WHAT TO DO. UNLOCKED AND COPY NOT ALLOWED WITH THE WRITTEN.	GENEL TOLERANS : PROFİL BOY TOLERANSI :	MATERİYAL MM MDF	TARİH / DATE 03.12.2018

18 mm Profiles

PROFİLSE - SİLAS ORMAN ÜRÜNLERİ

KAĞIT ÜZERİNDEN ÖLÇÜ ALMAYINIZ !!!
Don't measure on paper.

ÜRÜN KODU : 18*30
(Product Code)

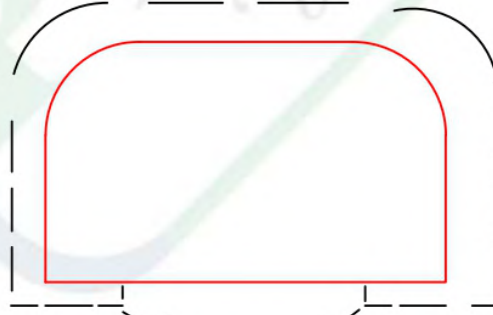
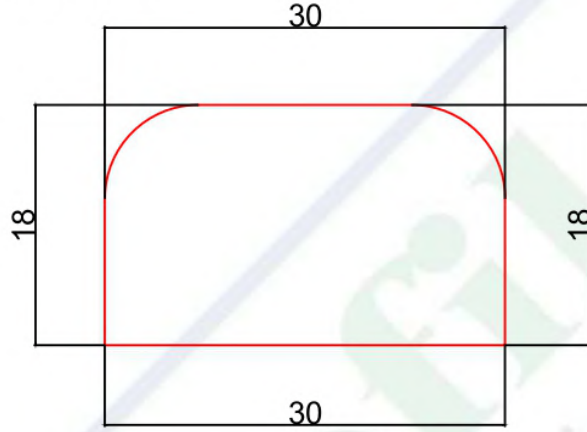

PVC BİTİŞ YERİ
(Pvc ending area)

BÖLÜM SORUMLUSU NEJDET ALTINTOPRAK	BU ÇİZİM PROFİLSE - SİLAS ORMAN ÜRÜNLERİ'NE AİTTİR. İZINSİZ ÇOĞALTILMAMAK VE KOPYA EDİLMEMEK ŞARTI İLE İZİN VERİLMİŞTİR.	PVC ENİ : MDF MİKTARI : PLAKADAN ÇIKAN :	KSM ÖLÇÜCÜ :	KUTU İÇİ : KUTU İÇİ ADET :
ARGE SORUMLUSU DOĞUKAN DEMİR	THIS DRAWING PROFILE - SİLAS FOREST PRODUCTS WHAT TO DO. UNLOCKED AND COPY NOT ALLOWED WITH THE WRITTEN.	GENEL TOLERANS : PROFİL BOY TOLERANSI :	MATERİYAL MM MDF	TARİH / DATE 04.10.2018

18 mm Profiles

PROFİLSE - SİLAS ORMAN ÜRÜNLERİ

KAĞIT ÜZERİNDEN ÖLÇÜ ALMAYINIZ !!!

Don't measurate on paper.

ÜRÜN KODU : 18*48

(Product Code)

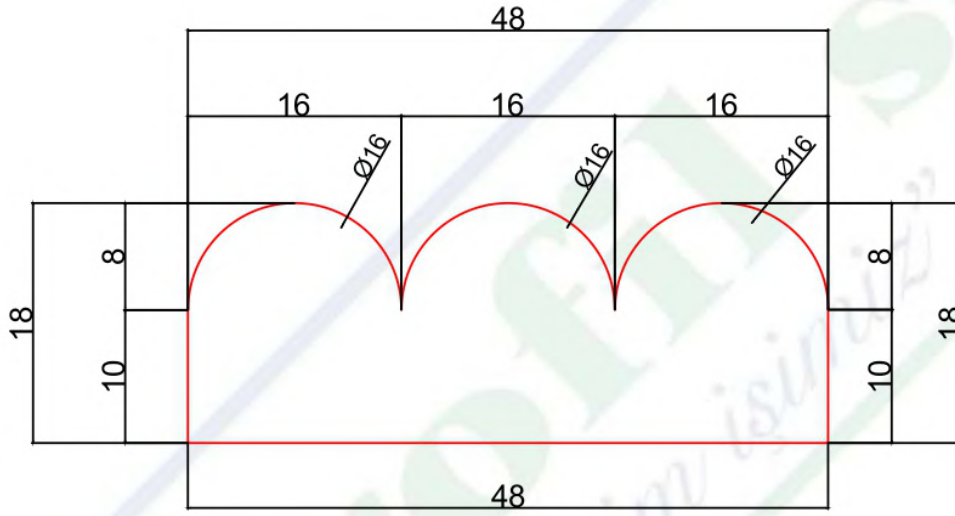

BÖLÜM SORUMLUSU NEJDET ALTINTOPRAK	BU ÇİZİM PROFİLSE - SİLAS ORMAN ÜRÜNLERİ'NE AİTTİR. İZİNSİZ ÇOĞALTILMAMAK VE KOPYA EDİLMEKEMEK ŞARTI İLE İZİN VERİLMİŞTİR.	PVC ENİ : MDF MİKTARI : PLAKADAN ÇIKAN :	KSM ÖLÇÜCÜ :	KUTU İÇİ : KUTU İÇİ ADET :
ARGE SORUMLUSU DOĞUKAN DEMİR	THIS DRAWING PROFILE - SILAS FOREST PRODUCTS WHAT TO DO. UNLOCKED AND COPY NOT ALLOWED WITH THE WRITTEN.	GENEL TOLERANS : PROFİL BOY TOLERANSI :	MATERİYAL MM MDF	TARİH / DATE 25.12.2018

18 mm Profiles

PROFİLSE - SİLAS ORMAN ÜRÜNLERİ

KAĞIT ÜZERİNDEN ÖLÇÜ ALMAYINIZ !!!
Don't measure on paper.

ÜRÜN KODU : 18*70
(Product Code)

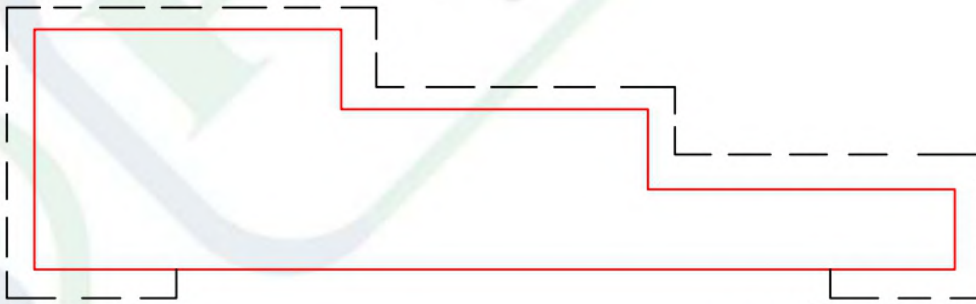
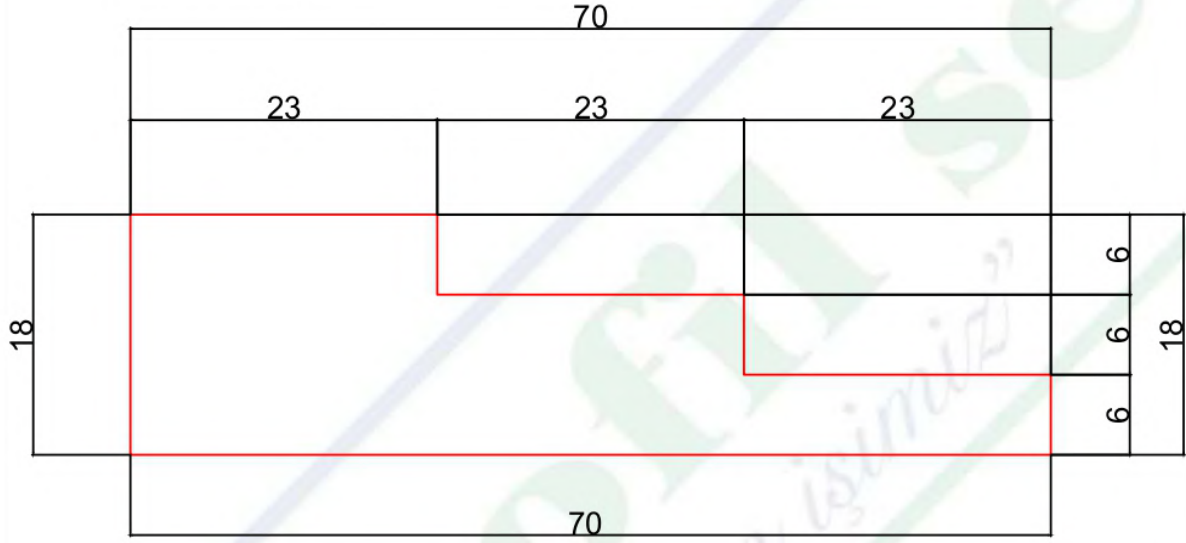

PVC BİTİŞ YERİ

(Pvc ending area)

BÖLÜM SORUMLUSU NEJDET ALTINTOPRAK	BU ÇİZİM PROFİLSE - SİLAS ORMAN ÜRÜNLERİ'NE AİTTİR. İZINSİZ ÇOĞALTILMAMAK VE KOPYA EDİLMEMEK ŞARTI İLE İZİN VERİLMİŞTİR.	PVC ENİ : MDF MİKTARI : PLAKADAN ÇIKAN :	KSM ÖLÇÜCÜ :	KUTU İÇİ : KUTU İÇİ ADET :
ARGE SORUMLUSU DOĞUKAN DEMİR	THIS DRAWING PROFILE - SİLAS FOREST PRODUCTS WHAT TO DO. UNLOCKED AND COPY NOT ALLOWED WITH THE WRITTEN.	GENEL TOLERANS : PROFİL BOY TOLERANSI :	MATERİYAL MM MDF	TARİH / DATE 12.11.2018

18 mm Profiles

PROFİLSE - SİLAS ORMAN ÜRÜNLERİ

ÜRÜN KODU : 18*36
(Product Code)

KAĞIT ÜZERİNDEN ÖLÇÜ ALMAYINIZ !!!
Don't measure on paper.

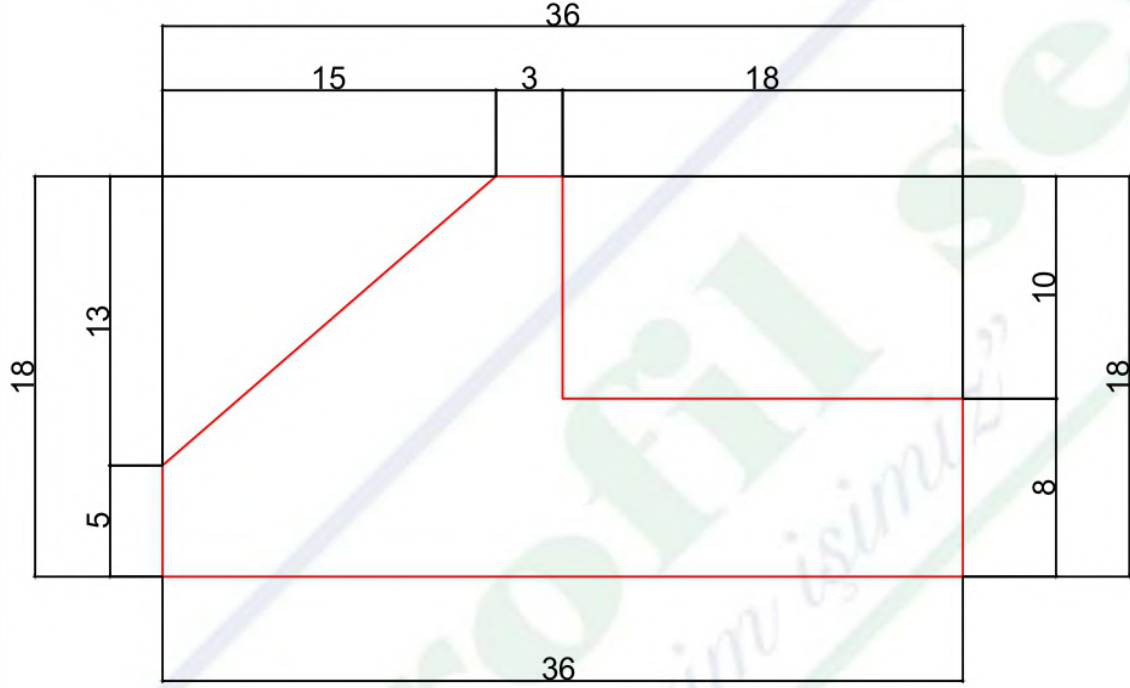

PVC BİTİŞ YERİ
(Pvc ending area)

BÖLÜM SORUMLUSU NEJDET ALTINTOPRAK	BU ÇİZİM PROFİLSE - SİLAS ORMAN ÜRÜNLERİ'NE AİTTİR. İZİNSİZ ÇOĞALTILMAMAK VE KOPYA EDİLMEK ŞARTI İLE İZİN VERİLMİŞTİR.	PVC ENİ : MDF MİKTARI : PLAKADAN ÇIKAN :	KSM ÖLÇÜCÜ :	KUTU İÇİ : KUTU İÇİ ADET :
ARGE SORUMLUSU DOĞUKAN DEMİR	THIS DRAWING PROFILE - SİLAS FOREST PRODUCTS WHAT TO DO. UNLOCKED AND COPY NOT ALLOWED WITH THE WRITTEN.	GENEL TOLERANS : PROFİL BOY TOLERANSI :	MATERİYAL MM MDF	TARİH / DATE 12.11.2018

18 mm Profiles

PROFİLSE - SİLAS ORMAN ÜRÜNLERİ

KAĞIT ÜZERİNDEN ÖLÇÜ ALMAYINIZ !!!

Don't measurate on paper.

ÜRÜN KODU : 18*52

(Product Code)

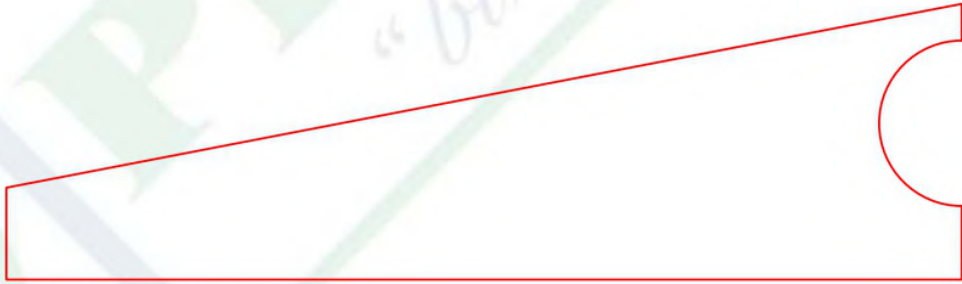

BÖLÜM SORUMLUSU NEJDET ALTINTOPRAK	BU ÇİZİM PROFİLSE - SİLAS ORMAN ÜRÜNLERİ'NE AİTTİR. İZINSİZ ÇOĞALTILMAMAK VE KOPYA EDİLMEMEK ŞARTI İLE İZİN VERİLMİŞTİR.	PVC ENİ : MDF MIKTARI : PLAKADAN ÇIKAN :	KSM ÖLÇÜCÜ :	KUTU İÇİ : KUTU İÇİ ADET :
ARGE SORUMLUSU DOĞUKAN DEMİR	THIS DRAWING PROFILE - SİLAS FOREST PRODUCTS WHAT TO DO. UNLOCKED AND COPY NOT ALLOWED WITH THE WRITTEN.	GENEL TOLERANS : PROFİL BOY TOLERANSI :	MATERİYAL MM MDF	TARİH / DATE 21.11.2018

18 mm Profiles

PROFİLSE - SİLAS ORMAN ÜRÜNLERİ

KAĞIT ÜZERİNDEN ÖLÇÜ ALMAYINIZ !!!

Don't measurate on paper.

ÜRÜN KODU : 18*75

(Product Code)

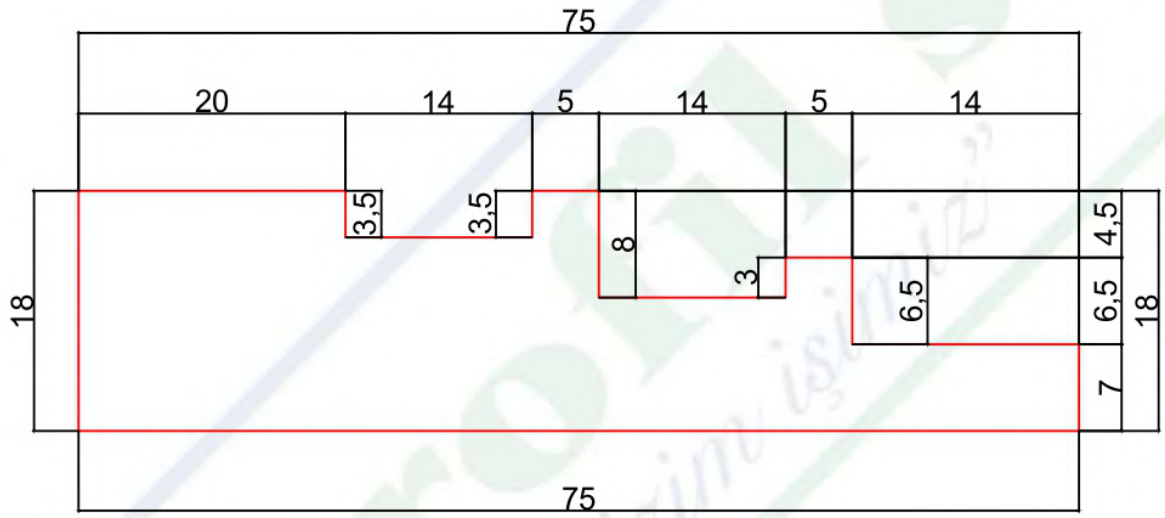

BÖLÜM SORUMLUSU NEJDET ALTINTOPRAK	BU ÇİZİM PROFİLSE - SİLAS ORMAN ÜRÜNLERİ'NE AİTTİR. İZİNSİZ ÇOĞALTILMAMAK VE KOPYA EDİLMEK ŞARTI İLE İZİN VERİLMİŞTİR.	PVC ENİ : MDF MİKTARI : PLAKADAN ÇIKAN :	KSM ÖLÇÜCÜ :	KUTU İÇİ : KUTU İÇİ ADET :
ARGE SORUMLUSU DOĞUKAN DEMİR	THIS DRAWING PROFILE - SİLAS FOREST PRODUCTS WHAT TO DO. UNLOCKED AND COPY NOT ALLOWED WITH THE WRITTEN.	GENEL TOLERANS : PROFİL BOY TOLERANSI :	MATERİYAL MM MDF	TARİH / DATE 21.11.2018

18 mm Profiles

PROFİLSE - SİLAS ORMAN ÜRÜNLERİ

KAĞIT ÜZERİNDEN ÖLÇÜ ALMAYINIZ !!!

Don't measurate on paper.

ÜRÜN KODU: 18*43
(Product Code)

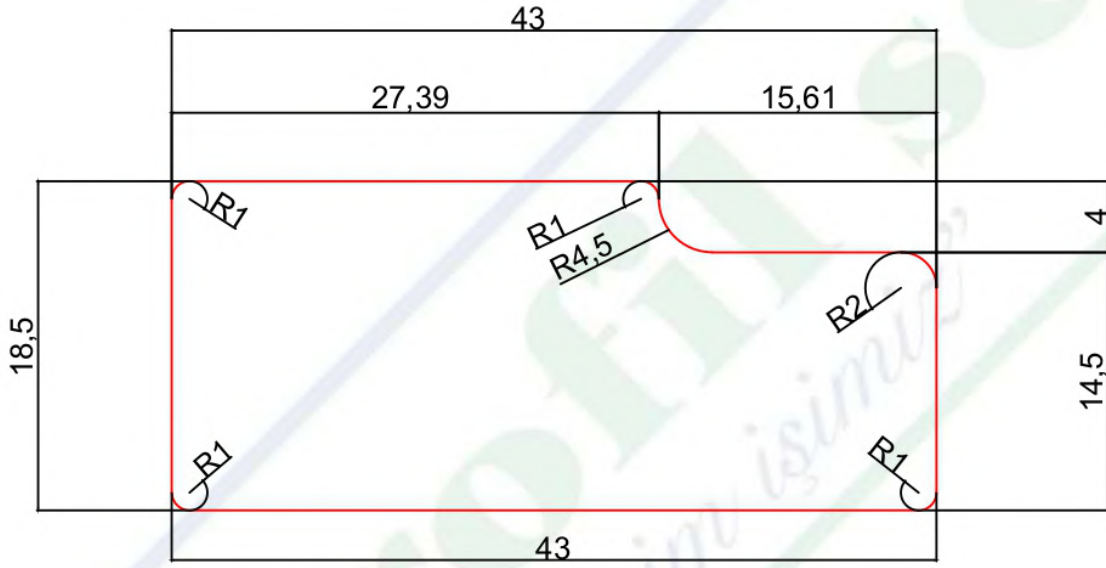

PVC BİTİŞ YERİ
(Pvc ending area)

BÖLÜM SORUMLUSU NEJDET ALTINTOPRAK	BU ÇİZİM PROFİLSE - SİLAS ORMAN ÜRÜNLERİ'NE AİTTİR. İZINSİZ ÇOĞALTILMAMAK VE KOPYA EDİLMEMEK ŞARTI İLE İZİN VERİLMİŞTİR.	PVC ENİ : MDF MİKTARI : PLAKADAN ÇIKAN :	KSM ÖLÇÜCÜ :	KUTU İÇİ : KUTU İÇİ ADET :
ARGE SORUMLUSU DOĞUKAN DEMİR	THIS DRAWING PROFILE - SİLAS FOREST PRODUCTS WHAT TO DO. UNLOCKED AND COPY NOT ALLOWED WITH THE WRITTEN.	GENEL TOLERANS : PROFİL BOY TOLERANSI :	MATERİYAL MM MDF	TARİH / DATE 10.12.2018

18 mm Profiles

PROFİLSE - SİLAS ORMAN ÜRÜNLERİ

KAĞIT ÜZERİNDEN ÖLÇÜ ALMAYINIZ !!!

ÜRÜN KODU : 18*25
(Product Code)

Don't measurate on paper.

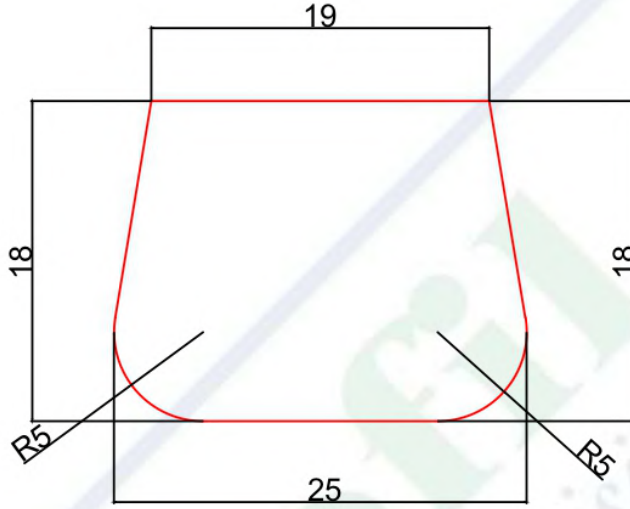

(Pvc ending area)

PVC BİTİŞ YERİ

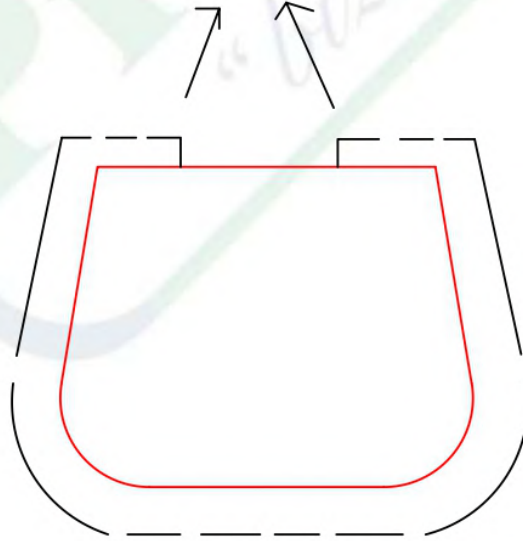

BÖLÜM SORUMLUSU NEJDET ALTINTOPRAK	BU ÇİZİM PROFİLSE - SİLAS ORMAN ÜRÜNLERİ'NE AİTTİR. İZİNSİZ ÇOĞALTILMAMAK VE KOPYA EDİLMEMEK ŞARTI İLE İZİN VERİLMİŞTİR.	PVC ENİ : MDF MİKTARI : PLAKADAN ÇIKAN :	KSM ÖLÇÜCÜ :	KUTU İÇİ : KUTU İÇİ ADET :
ARGE SORUMLUSU DOĞUKAN DEMİR	THIS DRAWING PROFILE - SILAS FOREST PRODUCTS WHAT TO DO. UNLOCKED AND COPY NOT ALLOWED WITH THE WRITTEN.	GENEL TOLERANS : PROFİL BOY TOLERANSI :	MATERİYAL MM MDF	TARİH / DATE 10.10.2018

18 mm Profiles

PROFİLSE - SİLAS ORMAN ÜRÜNLERİ

KAĞIT ÜZERİNDEN ÖLÇÜ ALMAYINIZ !!!

ÜRÜN KODU : 18*30
(Product Code)

Don't measurate on paper.

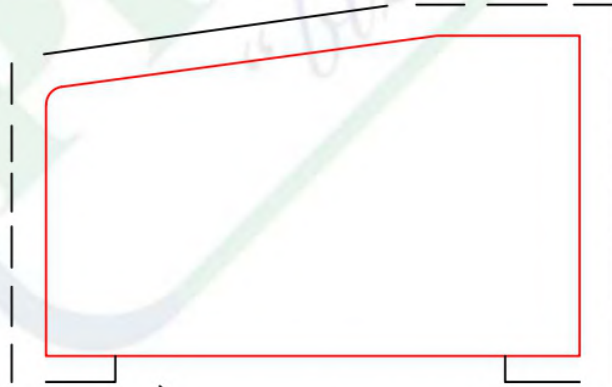
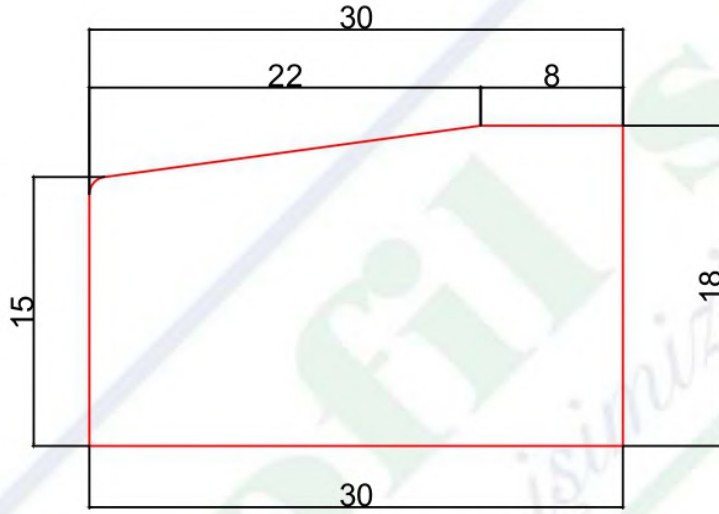

PVC BİTİŞ YERİ

(Pvc ending area)

BÖLÜM SORUMLUSU NEJDET ALTINTOPRAK	BU ÇİZİM PROFİLSE - SİLAS ORMAN ÜRÜNLERİ'NE AİTTİR. İZINSİZ ÇOĞALTILMAMAK VE KOPYA EDİLMEKEMEK ŞARTI İLE İZİN VERİLMİŞTİR.	PVC ENİ : MDF MİKTARI : PLAKADAN ÇIKAN :	KSM ÖLÇÜCÜ :	KUTU İÇİ : KUTU İÇİ ADET :
ARGE SORUMLUSU DOĞUKAN DEMİR	THIS DRAWING PROFILE - SİLAS FOREST PRODUCTS WHAT TO DO. UNLOCKED AND COPY NOT ALLOWED WITH THE WRITTEN.	GENEL TOLERANS : PROFİL BOY TOLERANSI :	MATERİAL MM MDF	TARİH / DATE 10.10.2018

18 mm Profiles

PROFİLSE - SİLAS ORMAN ÜRÜNLERİ

KAĞIT ÜZERİNDEN ÖLÇÜ ALMAYINIZ !!!

ÜRÜN KODU : 18*38

(Product Code)

Don't measurate on paper.

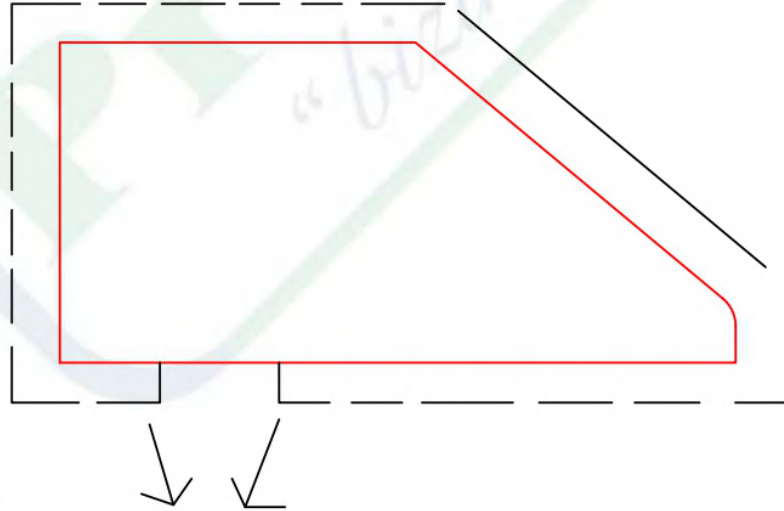
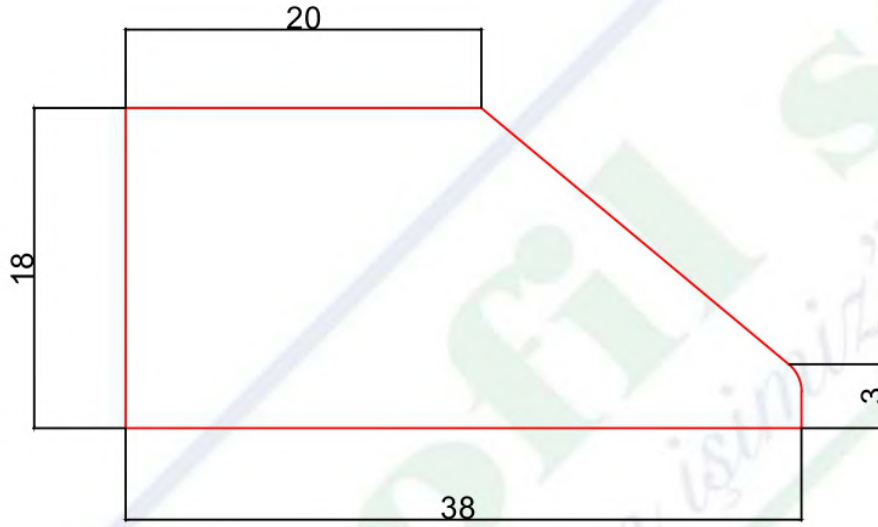

PVC BİTİŞ YERİ (Pvc ending area)

BÖLÜM SORUMLUSU NEJDET ALTINTOPRAK	BU ÇİZİM PROFİLSE - SİLAS ORMAN ÜRÜNLERİ'NE AİTTİR. İZİNSİZ ÇOĞALTILMAMAK VE KOPYA EDİLMEKEMEK ŞARTI İLE İZİN VERİLMİŞTİR.	PVC ENİ : MDF MİKTARI : PLAKADAN ÇIKAN :	KSM ÖLÇÜCÜ :	KUTU İÇİ : KUTU İÇİ ADET :
ARGE SORUMLUSU DOĞUKAN DEMİR	THIS DRAWING PROFILE - SİLAS FOREST PRODUCTS WHAT TO DO. UNLOCKED AND COPY NOT ALLOWED WITH THE WRITTEN.	GENEL TOLERANS : PROFL BOY TOLERANSI :	MATERİAL MM MDF	TARİH / DATE 10.10.2018

18 mm Profiles

PROFİLSE - SİLAS ORMAN ÜRÜNLERİ

KAGIT ÜZERİNDEN ÖLÇÜ ALMAYINIZ !!!

Don't measurate on paper.

ÜRÜN KODU: 18*115

(Product Code)

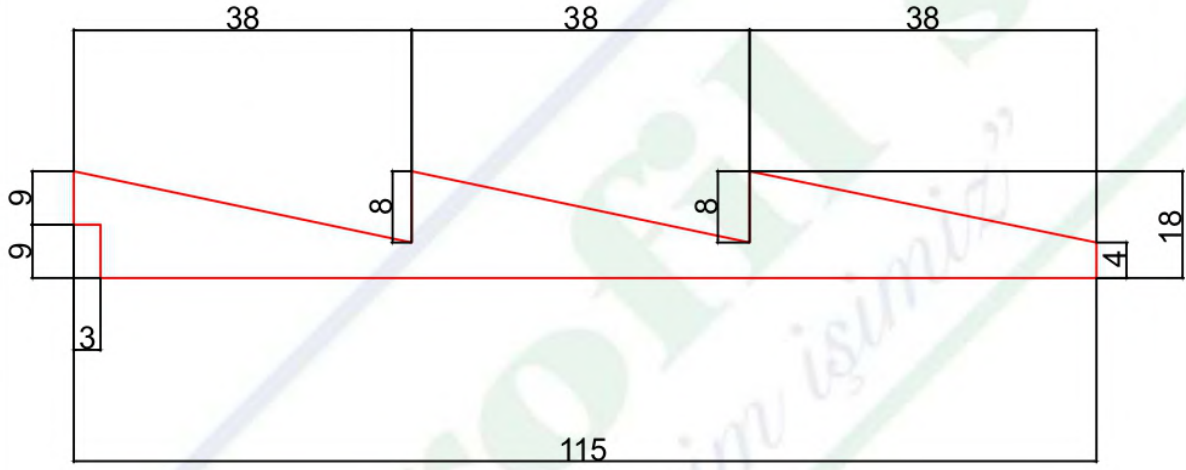

BÖLÜM SORUMLUSU NEJDET ALTINTOPRAK	BU ÇİZİM PROFİLSE - SİLAS ORMAN ÜRÜNLERİ'NE AİTTİR. İZINSİZ ÇOĞALTILMAMAK VE KOPYA EDİLMEKEMEK ŞARTI İLE İZİN VERİLMİŞTİR.	PVC ENİ : MDF MİKTARI : PLAKADAN ÇIKAN :	KSM ÖLÇÜCÜ :	KUTU İÇİ : KUTU İÇİ ADET :
ARGE SORUMLUSU DOĞUKAN DEMİR	THIS DRAWING PROFILE - SILAS FOREST PRODUCTS WHAT TO DO. UNLOCKED AND COPY NOT ALLOWED WITH THE WRITTEN.	GENEL TOLERANS : PROFİL BOY TOLERANSI :	MATERIAL MM MDF	TARİH / DATE 22.10.2018

18 mm Profiles

PROFİLSE - SİLAS ORMAN ÜRÜNLERİ

KAĞIT ÜZERİNDEN ÖLÇÜ ALMAYINIZ !!!

Don't measurate on paper.

ÜRÜN KODU : 18*70-03
(Product Code)

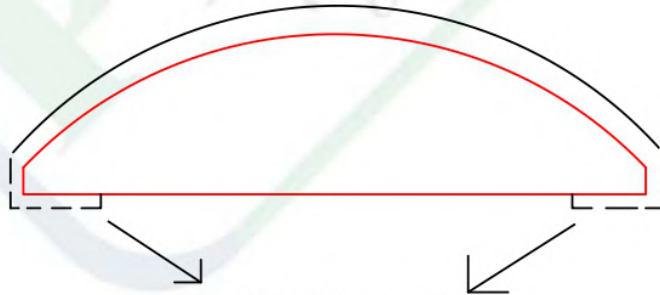
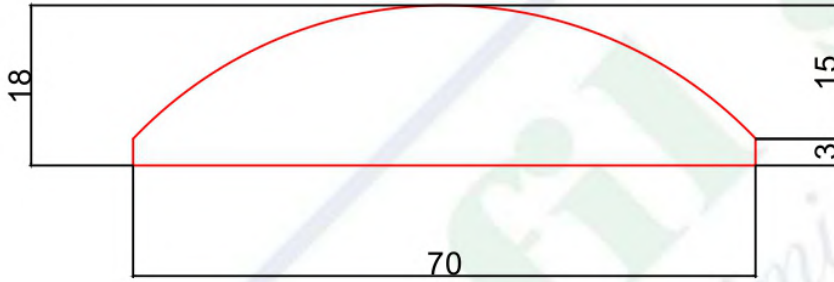

PVC BİTİŞ YERİ
(Pvc ending area)

BÖLÜM SORUMLUSU NEJDET ALTINTOPRAK	BU ÇİZİM PROFİLSE - SİLAS ORMAN ÜRÜNLERİ'NE AİTTİR. İZINSİZ ÇOĞALTILMAMAK VE KOPYA EDİLMEMEK ŞARTI İLE İZİN VERİLMİŞTİR.	PVC ENİ : MDF MİKTARI : PLAKADAN ÇIKAN :	KSM ÖLÇÜCÜ :	KUTU İÇİ : KUTU İÇİ ADET :
ARGE SORUMLUSU DOĞUKAN DEMİR	THIS DRAWING PROFILE - SİLAS FOREST PRODUCTS WHAT TO DO. UNLOCKED AND COPY NOT ALLOWED WITH THE WRITTEN.	GENEL TOLERANS : PROFL BOY TOLERANSI :	MATERİYAL MM MDF	TARİH / DATE 14.11.2018

18 mm Profiles

PROFİLSE - SİLAS ORMAN ÜRÜNLERİ

KAĞIT ÜZERİNDEN ÖLÇÜ ALMAYINIZ !!!
Don't measure on paper.

ÜRÜN KODU : 18*40
(Product Code)

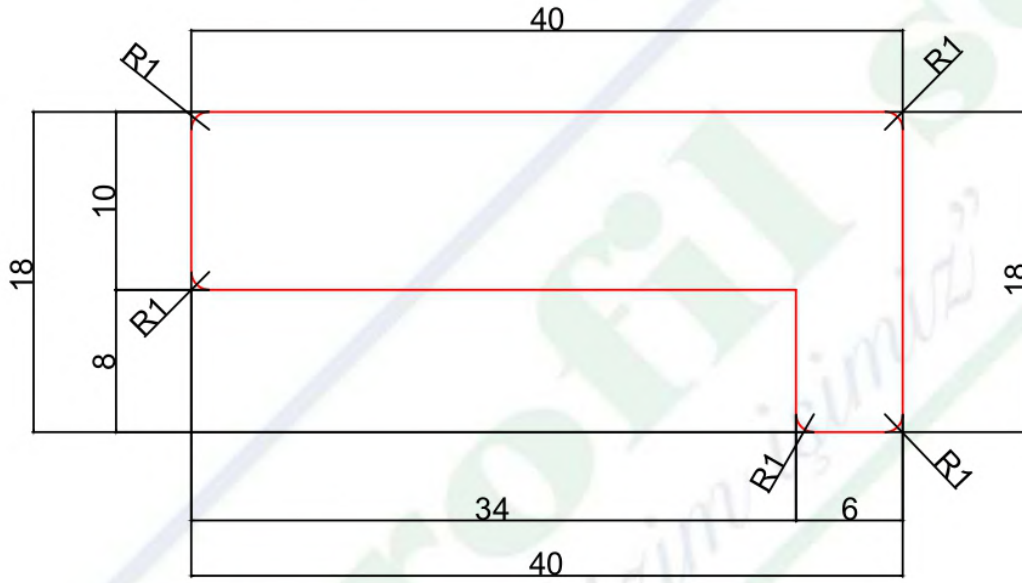

PVC BİTİŞ YERİ
(Pvc ending area)

BÖLÜM SORUMLUSU NEJDET ALTINTOPRAK	BU ÇİZİM PROFİLSE - SİLAS ORMAN ÜRÜNLERİ'NE AİTTİR. İZINSİZ ÇOĞALTILMAMAK VE KOPYA EDİLMEK ŞARTI İLE İZİN VERİLMİŞTİR.	PVC ENİ : MDF MİKTARI : PLAKADAN ÇIKAN :	KSM ÖLÇÜCÜ :	KUTU İÇİ : KUTU İÇİ ADET :
ARGE SORUMLUSU DOĞUKAN DEMİR	THIS DRAWING PROFILE - SİLAS FOREST PRODUCTS WHAT TO DO. UNLOCKED AND COPY NOT ALLOWED WITH THE WRITTEN.	GENEL TOLERANS : PROFİL BOY TOLERANSI :	MATERİYAL MM MDF	TARİH / DATE 04.12.2018

18 mm Profiles

PROFİLSE - SİLAS ORMAN ÜRÜNLERİ

KAĞIT ÜZERİNDEN ÖLÇÜ ALMAYINIZ !!!
Don't measure on paper.

ÜRÜN KODU : 18*50
(Product Code)

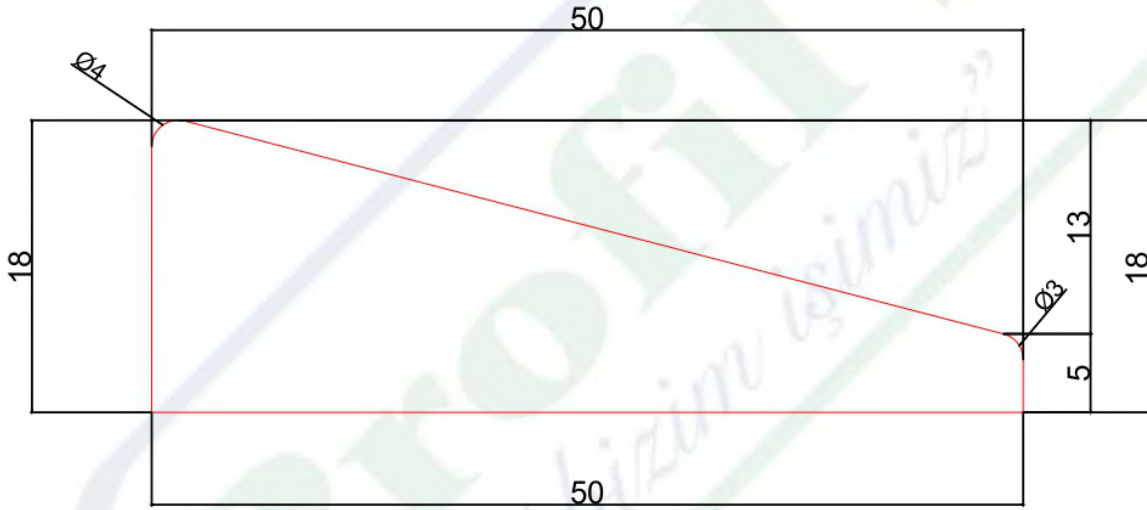

PVC

BÖLÜM SORUMLUSU NEJDET ALTINTOPRAK	BU ÇİZİM PROFİLSE - SİLAS ORMAN ÜRÜNLERİ'NE AİTTİR. İZINSİZ ÇOĞALTILMAMAK VE KOPYA EDİLMEK ŞARTI İLE İZİN VERİLMİŞTİR.	PVC ENİ : MDF MİKTARI : PLAKADAN ÇIKAN :	KSM ÖLÇÜCÜ :	KUTU İÇİ : KUTU İÇİ ADET :
ARGE SORUMLUSU DOĞUKAN DEMİR	THIS DRAWING PROFILE - SİLAS FOREST PRODUCTS WHAT TO DO. UNLOCKED AND COPY NOT ALLOWED WITH THE WRITTEN.	GENEL TOLERANS : PROFİL BOY TOLERANSI :	MATERİYAL MM MDF	TARİH / DATE 26.11.2018

18 mm Profiles

PROFİLSE - SİLAS ORMAN ÜRÜNLERİ

KAĞIT ÜZERİNDEN ÖLÇÜ ALMAYINIZ !!!

Don't measurate on paper.

ÜRÜN KODU : 18*50-02

(Product Code)

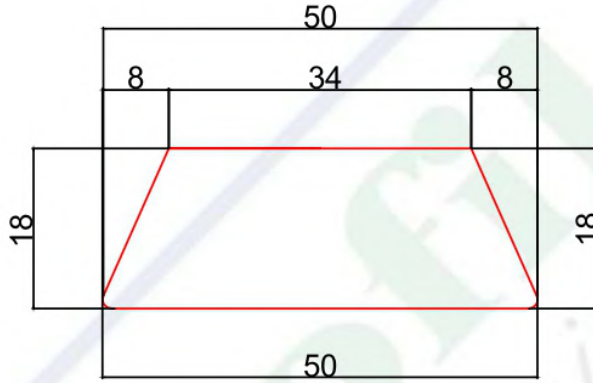

(Pvc ending area)

PVC BİTİŞ YERİ



BÖLÜM SORUMLUSU NEJDET ALTINTOPRAK	BU ÇİZİM PROFİLSE - SİLAS ORMAN ÜRÜNLERİ'NE AİTTİR. İZINSİZ ÇOĞALTILMAMAK VE KOPYA EDİLMEKEMEK ŞARTI İLE İZİN VERİLMİŞTİR.	PVC ENİ : MDF MİKTARI : PLAKADAN ÇIKAN :	KSM ÖLÇÜCÜ :	KUTU İÇİ : KUTU İÇİ ADET :
ARGE SORUMLUSU DOĞUKAN DEMİR	THIS DRAWING PROFILE - SILAS FOREST PRODUCTS WHAT TO DO. UNLOCKED AND COPY NOT ALLOWED WITH THE WRITTEN.	GENEL TOLERANS : PROFİL BOY TOLERANSI :	MATERİYAL MM MDF	TARİH / DATE 04.10.2018

18 mm Profiles

PROFİLSE - SİLAS ORMAN ÜRÜNLERİ

ÜRÜN KODU : 18*25
(Product Code)

KAĞIT ÜZERİNDEN ÖLÇÜ ALMAYINIZ !!!
Don't measure on paper.

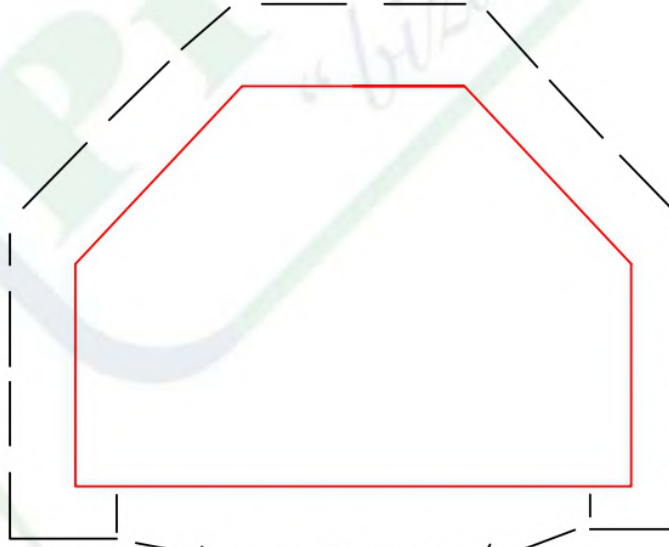
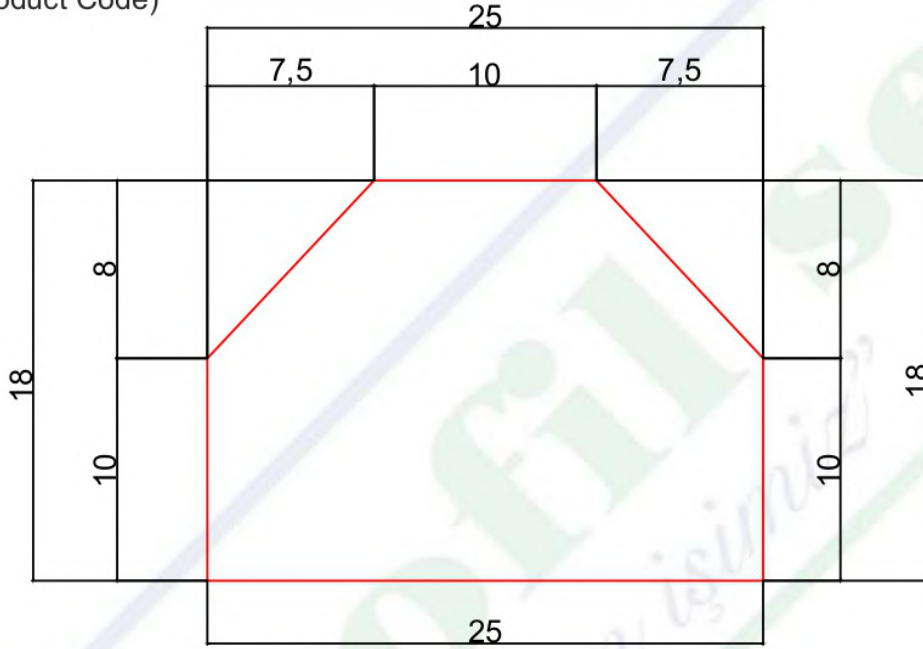

PVC BİTİŞ YERİ
(Pvc ending area)

BÖLÜM SORUMLUSU NEJDET ALTINTOPRAK	BU ÇİZİM PROFİLSE - SİLAS ORMAN ÜRÜNLERİ'NE AİTTİR. İZINSİZ ÇOĞALTILMAMAK VE KOPYA EDİLMEMEK ŞARTI İLE İZİN VERİLMİŞTİR.	PVC ENİ : MDF MİKTARI : PLAKADAN ÇIKAN :	KSM ÖLÇÜCÜ :	KUTU İÇİ : KUTU İÇİ ADET :
ARGE SORUMLUSU DOĞUKAN DEMİR	THIS DRAWING PROFILE - SİLAS FOREST PRODUCTS WHAT TO DO. UNLOCKED AND COPY NOT ALLOWED WITH THE WRITTEN.	GENEL TOLERANS : PROFİL BOY TOLERANSI :	MATERİYAL MM MDF	TARİH / DATE 04.10.2018

18 mm Profiles

PROFİLSE - SİLAS ORMAN ÜRÜNLERİ

KAĞIT ÜZERİNDEN ÖLÇÜ ALMAYINIZ !!!

ÜRÜN KODU : 16*40

(Product Code)

Don't measurate on paper.

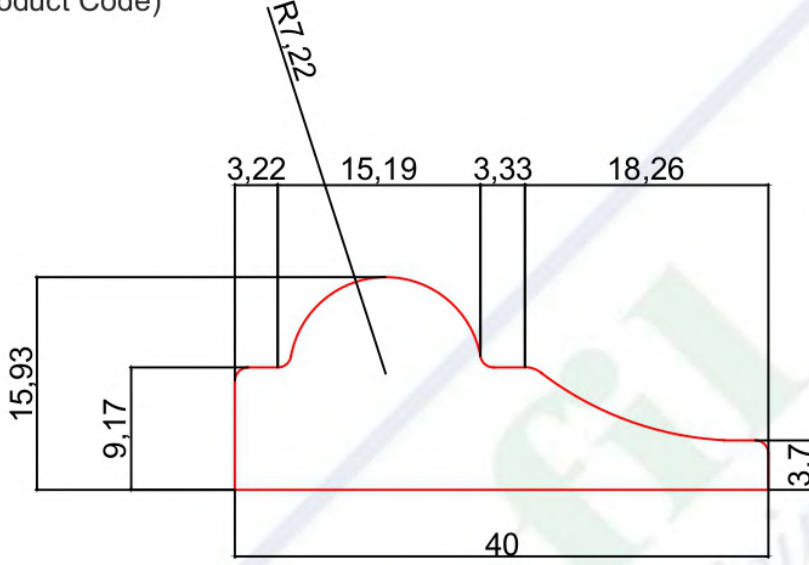

PVC BİTİŞ YERİ
(Pvc ending area)

BÖLÜM SORUMLUSU NEJDET ALTINTOPRAK	BU ÇİZİM PROFİLSE - SİLAS ORMAN ÜRÜNLERİ'NE AİTTİR. İZİNSİZ ÇOĞALTILMAMAK VE KOPYA EDİLMEMEK ŞARTI İLE İZİN VERİLMİŞTİR.	PVC ENİ : MDF MİKTARI : PLAKADAN ÇIKAN :	KSM ÖLÇÜCÜ :	KUTU İÇİ : KUTU İÇİ ADET :
ARGE SORUMLUSU DOĞUKAN DEMİR	THIS DRAWING PROFILE - SİLAS FOREST PRODUCTS WHAT TO DO. UNLOCKED AND COPY NOT ALLOWED WITH THE WRITTEN.	GENEL TOLERANS : PROFL BOY TOLERANSI :	MATERİYAL MM MDF	TARİH / DATE 5.11.2018

18 mm Profiles

PROFİLSE - SİLAS ORMAN ÜRÜNLERİ

KAĞIT ÜZERİNDEN ÖLÇÜ ALMAYINIZ !!!

Don't measurate on paper.

ÜRÜN KODU : 18*50

(Product Code)

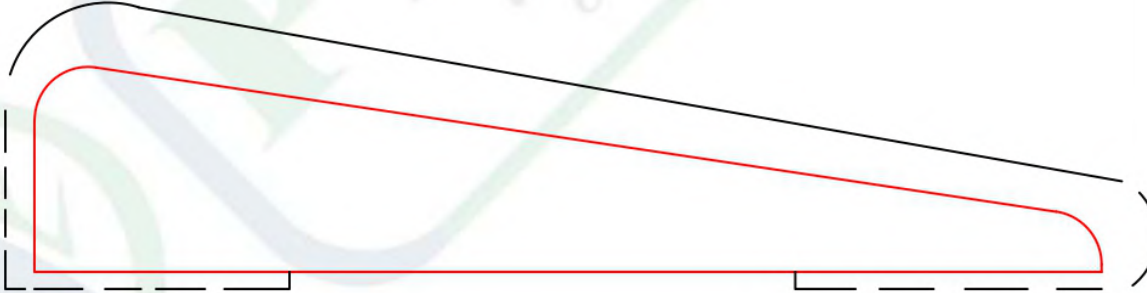
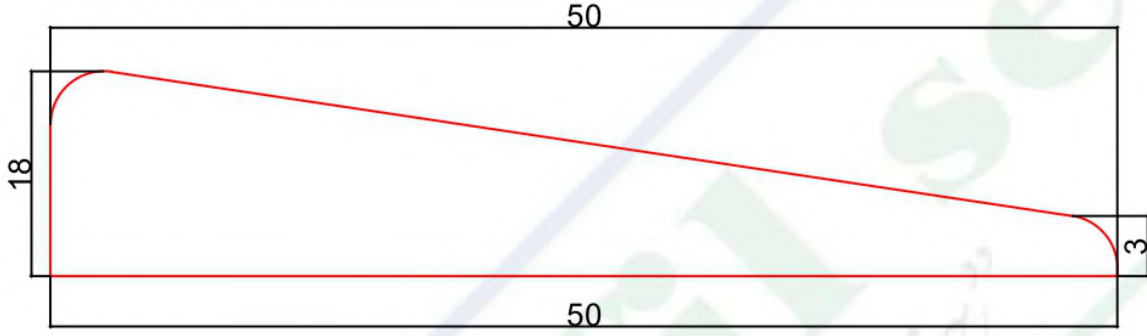

PVC BİTİŞ YERİ
(Pvc ending area)

BÖLÜM SORUMLUSU NEJDET ALTINTOPRAK	BU ÇİZİM PROFİLSE - SİLAS ORMAN ÜRÜNLERİ'NE AİTTİR. İZİNSİZ ÇOĞALTILMAMAK VE KOPYA EDİLMEKEMEK ŞARTI İLE İZİN VERİLMİŞTİR.	PVC ENİ : MDF MİKTARI : PLAKADAN ÇIKAN :	KSM ÖLÇÜCÜ :	KUTU İÇİ : KUTU İÇİ ADET :
ARGE SORUMLUSU DOĞUKAN DEMİR	THIS DRAWING PROFILE - SİLAS FOREST PRODUCTS WHAT TO DO. UNLOCKED AND COPY NOT ALLOWED WITH THE WRITTEN.	GENEL TOLERANS : PROFİL BOY TOLERANSI :	MATERİYAL MM MDF	TARİH / DATE 12.11.2018

18 mm Profiles

PROFİLSE - SİLAS ORMAN ÜRÜNLERİ

ÜRÜN KODU : 18*36
(Product Code)

KAGIT ÜZERİNDEN ÖLÇÜ ALMAYINIZ !!!

Don't measurate on paper.

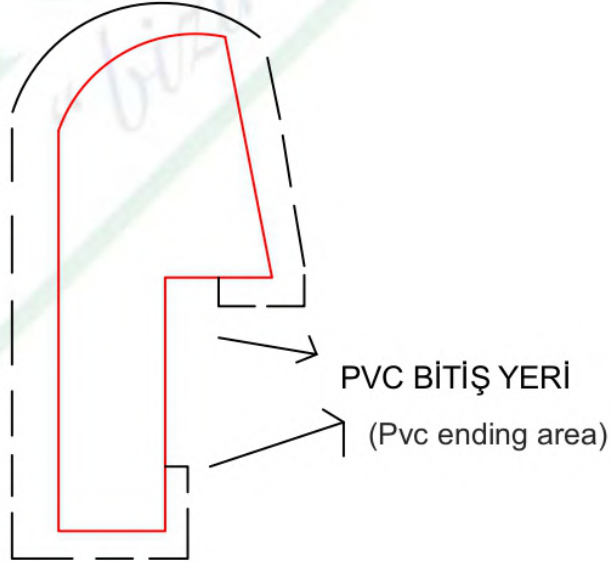
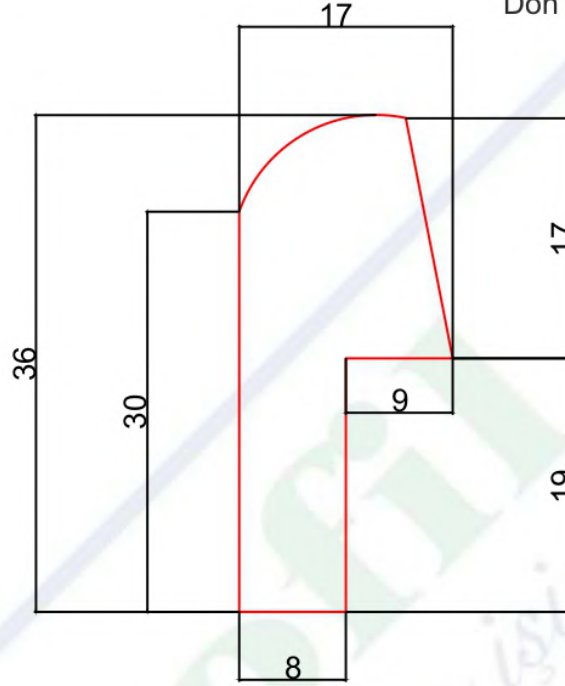

BÖLÜM SORUMLUSU NEJDET ALTINTOPRAK	BU ÇİZİM PROFİLSE - SİLAS ORMAN ÜRÜNLERİ'NE AİTTİR. İZINSİZ ÇOĞALTILMAMAK VE KOPYA EDİLMEK ŞARTI İLE İZİN VERİLMİŞTİR.	PVC ENİ : MDF MİKTARI : PLAKADAN ÇIKAN :	KSM ÖLÇÜCÜ :	KUTU İÇİ : KUTU İÇİ ADET :
ARGE SORUMLUSU DOĞUKAN DEMİR	THIS DRAWING PROFILE - SILAS FOREST PRODUCTS WHAT TO DO. UNLOCKED AND COPY NOT ALLOWED WITH THE WRITTEN.	GENEL TOLERANS : PROFİL BOY TOLERANSI :	MATERIAL MM MDF	TARİH / DATE 12.10.2018

18 mm Profiles

PROFİLSE - SİLAS ORMAN ÜRÜNLERİ

ÜRÜN KODU : 18*56
(Product Code)

KAĞIT ÜZERİNDEN ÖLÇÜ ALMAYINIZ !!!
Don't measure on paper.

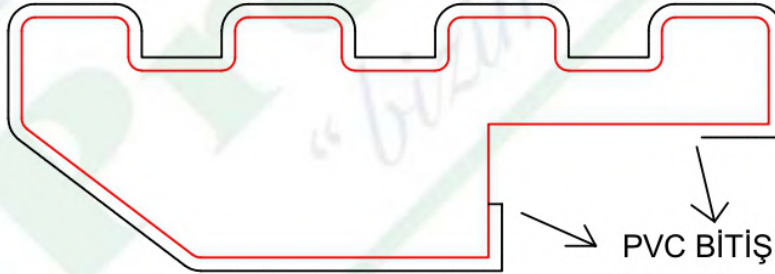
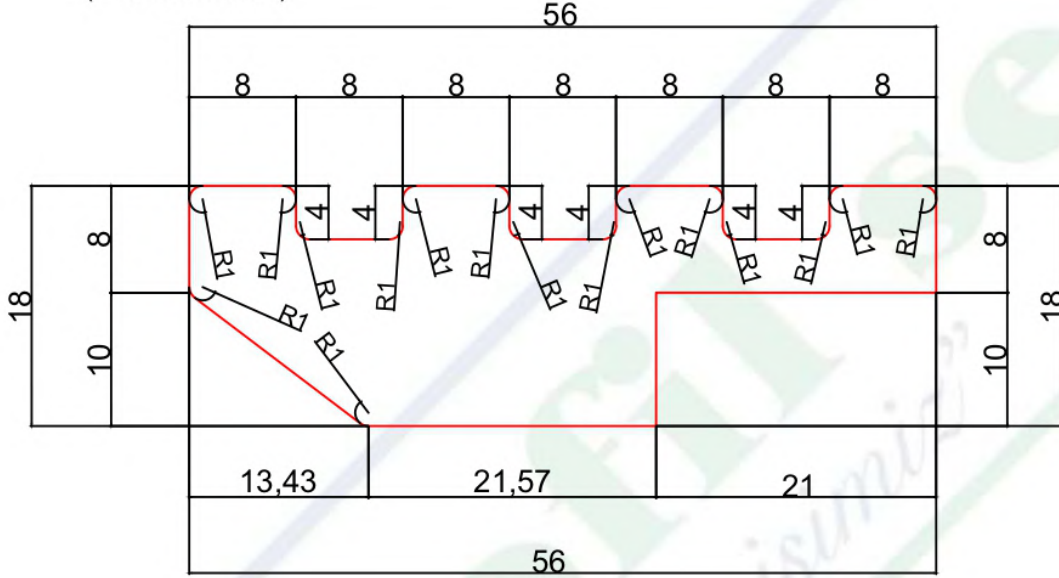

PVC BİTİŞ YERİ
(Pvc ending area)

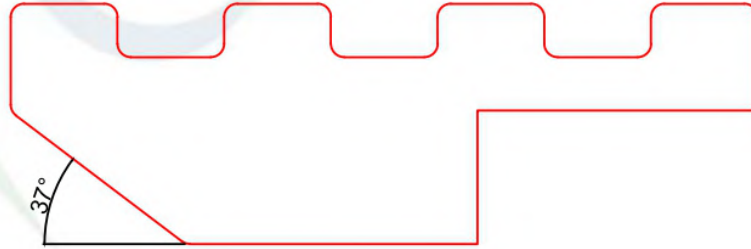

BÖLÜM SORUMLUSU NEJDET ALTINTOPRAK	BU ÇİZİM PROFİLSE - SİLAS ORMAN ÜRÜNLERİ'NE AİTTİR. İZİNSİZ ÇOĞALTILMAMAK VE KOPYA EDİLMEMEK ŞARTI İLE İZİN VERİLMİŞTİR.	PVC ENİ : MDF MİKTARI : PLAKADAN ÇIKAN :	KSM ÖLÇÜCÜ :	KUTU İÇİ : KUTU İÇİ ADET :
ARGE SORUMLUSU DOĞUKAN DEMİR	THIS DRAWING PROFILE - SİLAS FOREST PRODUCTS WHAT TO DO. UNLOCKED AND COPY NOT ALLOWED WITH THE WRITTEN.	GENEL TOLERANS : PROFİL BOY TOLERANSI :	MATERİYAL : MM MDF	TARİH / DATE 4.01.2019

18 mm Profiles

PROFİLSE - SİLAS ORMAN ÜRÜNLERİ

KAĞIT ÜZERİNDEN ÖLÇÜ ALMAYINIZ !!!

Don't measure on paper.

ÜRÜN KODU : 18*66

(Product Code)

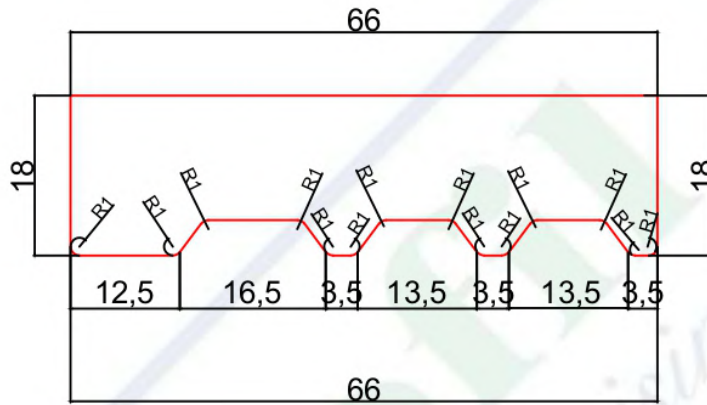

(Pvc ending area)

PVC BİTİM YERİ

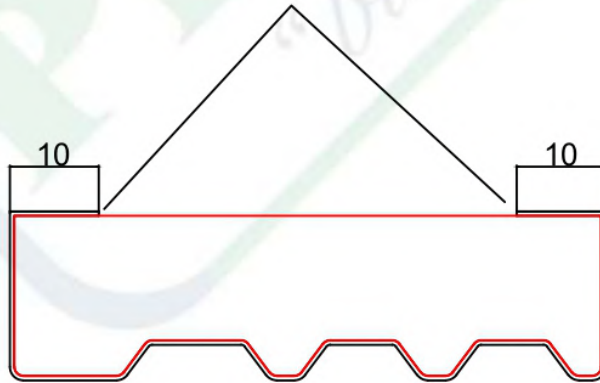

BÖLÜM SORUMLUSU NEJDET ALTINTOPRAK	BU ÇİZİM PROFİLSE - SİLAS ORMAN ÜRÜNLERİ'NE AİTTİR. İZİNSİZ ÇOĞALTILMAMAK VE KOPYA EDİLMEMEK ŞARTI İLE İZİN VERİLMİŞTİR.	PVC ENİ : MDF MİKTARI : PLAKADAN ÇIKAN :	KSM ÖLÇÜCÜ :	KUTU İÇİ : KUTU İÇİ ADET :
ARGE SORUMLUSU DOĞUKAN DEMİR	THIS DRAWING PROFILE - SİLAS FOREST PRODUCTS WHAT TO DO. UNLOCKED AND COPY NOT ALLOWED WITH THE WRITTEN.	GENEL TOLERANS : PROFİL BOY TOLERANSI :	MATERİYAL MM MDF	TARİH / DATE 16.01.2019

18 mm Profiles

PROFİLSE - SİLAS ORMAN ÜRÜNLERİ

KAĞIT ÜZERİNDEN ÖLÇÜ ALMAYINIZ !!!
Don't measure on paper.

ÜRÜN KODU : 18*70 (310)
(Product Code)

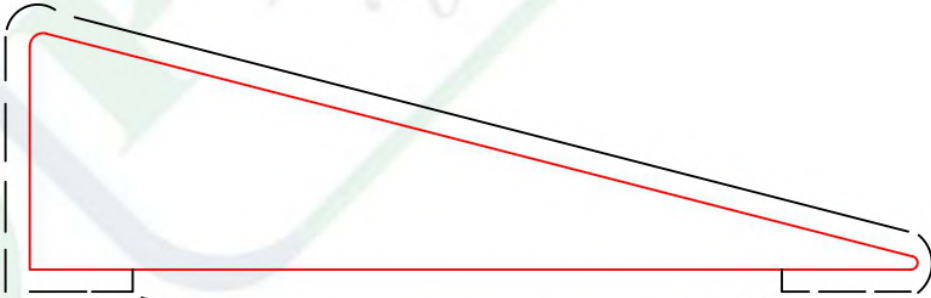
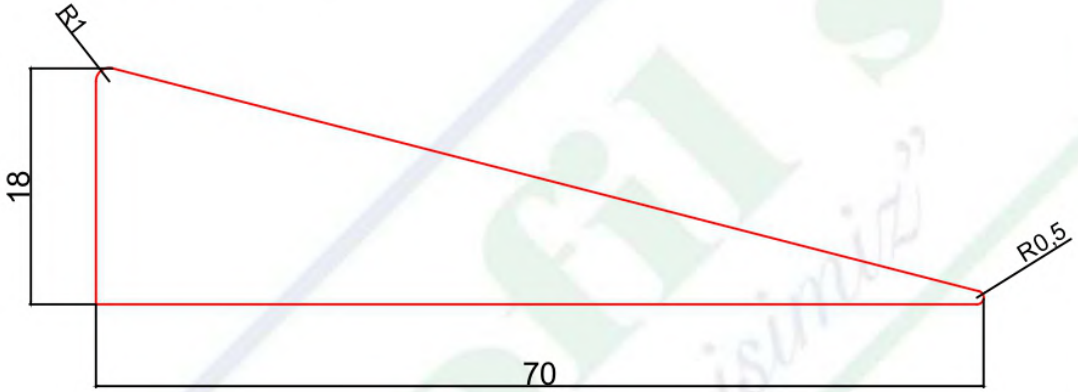

PVC BİTİŞ YERİ

(Pvc ending area)

BÖLÜM SORUMLUSU NEJDET ALTINTOPRAK	BU ÇİZİM PROFİLSE - SİLAS ORMAN ÜRÜNLERİ'NE AİTTİR. İZİNSİZ ÇOĞALTILMAMAK VE KOPYA EDİLMEMEK ŞARTI İLE İZİN VERİLMİŞTİR.	PVC ENİ : MDF MİKTARI : PLAKADAN ÇIKAN :	KSM ÖLÇÜCÜ :	KUTU İÇİ : KUTU İÇİ ADET :
ARGE SORUMLUSU DOĞUKAN DEMİR	THIS DRAWING PROFILE - SİLAS FOREST PRODUCTS WHAT TO DO. UNLOCKED AND COPY NOT ALLOWED WITH THE WRITTEN.	GENEL TOLERANS : PROFİL BOY TOLERANSI :	MATERİYAL MM MDF	TARİH / DATE 07.02.2019

18 mm Profiles

PROFİLSE - SİLAS ORMAN ÜRÜNLERİ

KAĞIT ÜZERİNDEN ÖLÇÜ ALMAYINIZ !!!
Don't measure on paper.

ÜRÜN KODU : 18*50
(Product Code)

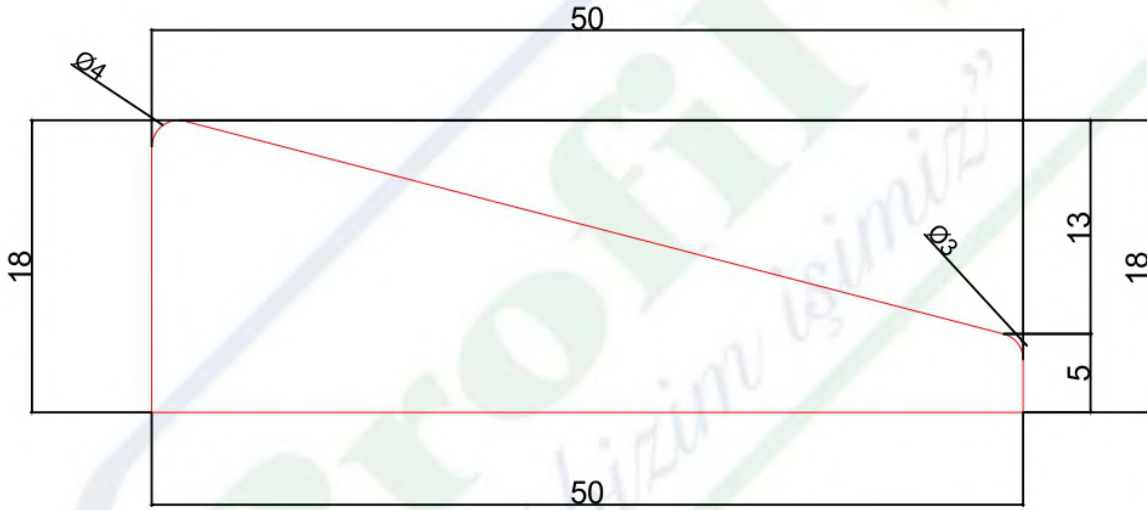

PVC

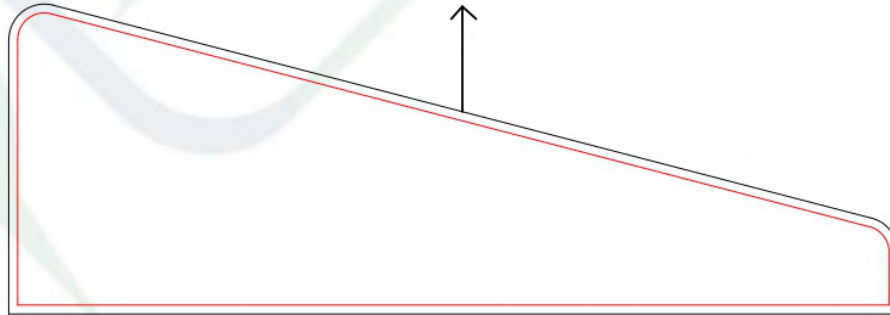

BÖLÜM SORUMLUSU NEJDET ALTINTOPRAK	BU ÇİZİM PROFİLSE - SİLAS ORMAN ÜRÜNLERİ'NE AİTTİR. İZİNSİZ ÇOĞALTILMAMAK VE KOPYA EDİLMEK ŞARTI İLE İZİN VERİLMİŞTİR.	PVC ENİ : MDF MİKTARI : PLAKADAN ÇIKAN :	KSM ÖLÇÜCÜ :	KUTU İÇİ : KUTU İÇİ ADET :
ARGE SORUMLUSU DOĞUKAN DEMİR	THIS DRAWING PROFILE - SİLAS FOREST PRODUCTS WHAT TO DO. UNLOCKED AND COPY NOT ALLOWED WITH THE WRITTEN.	GENEL TOLERANS : PROFİL BOY TOLERANSI :	MATERİYAL MM MDF	TARİH / DATE 16.01.2019

18 mm Profiles

PROFİLSE - SİLAS ORMAN ÜRÜNLERİ

KAĞIT ÜZERİNDEN ÖLÇÜ ALMAYINIZ !!!
Don't measurate on paper.

ÜRÜN KODU : 18*14

(Product Code)

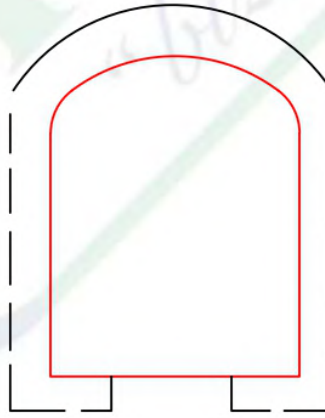
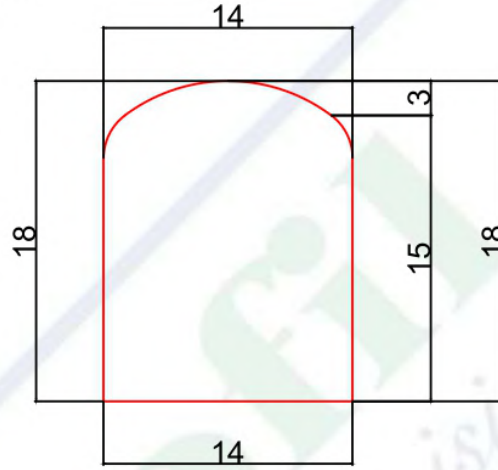

PVC BİTİŞ YERİ
(Pvc ending area)

BÖLÜM SORUMLUSU NEJDET ALTINTOPRAK	BU ÇİZİM PROFİLSE - SİLAS ORMAN ÜRÜNLERİ'NE AİTTİR. İZINSİZ ÇOĞALTILMAMAK VE KOPYA EDİLMEMEK ŞARTI İLE İZİN VERİLMİŞTİR.	PVC ENİ : MDF MİKTARI : PLAKADAN ÇIKAN :	KSM ÖLÇÜCÜ :	KUTU İÇİ : KUTU İÇİ ADET :
ARGE SORUMLUSU DOĞUKAN DEMİR	THIS DRAWING PROFILE - SİLAS FOREST PRODUCTS WHAT TO DO. UNLOCKED AND COPY NOT ALLOWED WITH THE WRITTEN.	GENEL TOLERANS : PROFİL BOY TOLERANSI :	MATERİYAL MM MDF	TARİH / DATE 04.10.2018

18 mm Profiles

PROFİLSE - SİLAS ORMAN ÜRÜNLERİ

KAĞIT ÜZERİNDEN ÖLÇÜ ALMAYINIZ !!!
Don't measure on paper.

ÜRÜN KODU : 18*35-07
(Product Code)

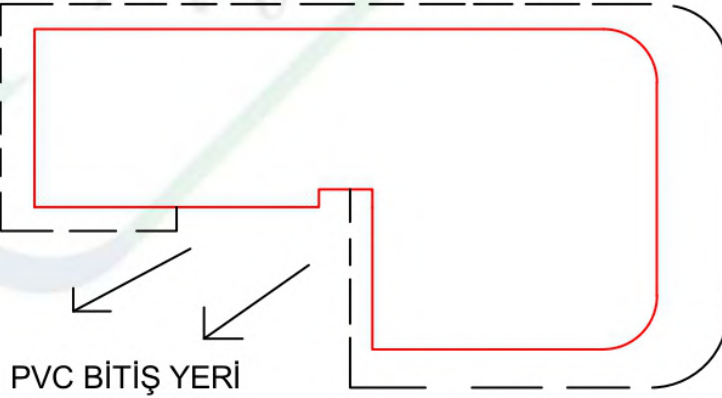
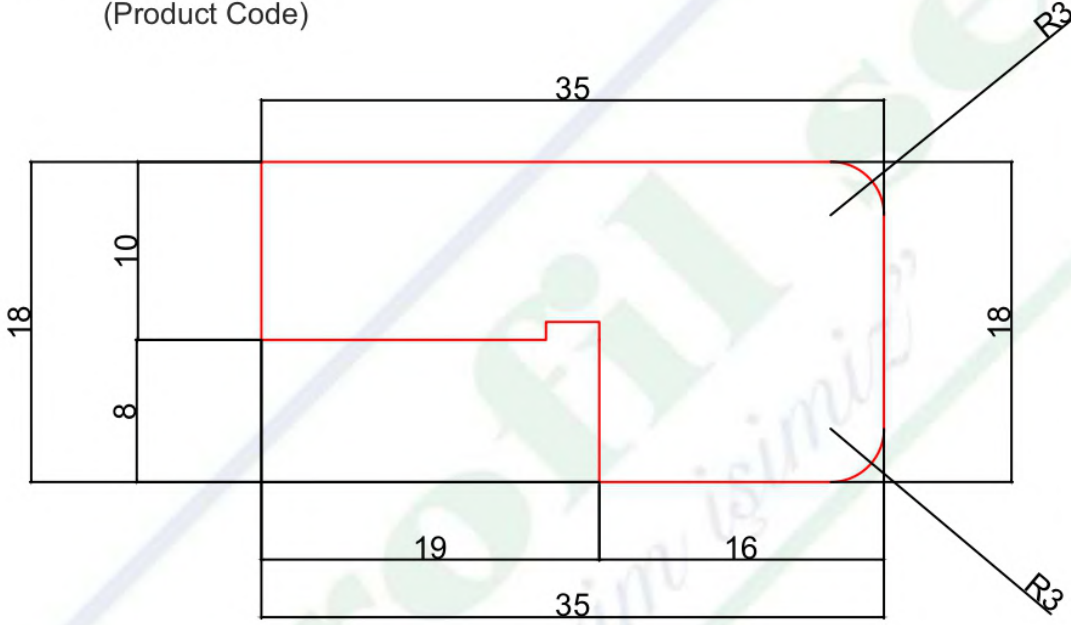

(Pvc ending area)

BÖLÜM SORUMLUSU NEJDET ALTINTOPRAK	BU ÇİZİM PROFİLSE - SİLAS ORMAN ÜRÜNLERİ'NE AİTTİR. İZINSİZ ÇOĞALTILMAMAK VE KOPYA EDİLMEMEK ŞARTI İLE İZİN VERİLMİŞTİR.	PVC ENİ : MDF MİKTARI : PLAKADAN ÇIKAN :	KSM ÖLÇÜCÜ :	KUTU İÇİ : KUTU İÇİ ADET :
ARGE SORUMLUSU DOĞUKAN DEMİR	THIS DRAWING PROFILE - SİLAS FOREST PRODUCTS WHAT TO DO. UNLOCKED AND COPY NOT ALLOWED WITH THE WRITTEN.	GENEL TOLERANS : PROFİL BOY TOLERANSI :	MATERİYAL MM MDF	TARİH / DATE 04.10.2018

18 mm Profiles

PROFİLSE - SİLAS ORMAN ÜRÜNLERİ

KAĞIT ÜZERİNDEN ÖLÇÜ ALMAYINIZ !!!

Don't measurate on paper.

ÜRÜN KODU : 18*50
(Product Code)

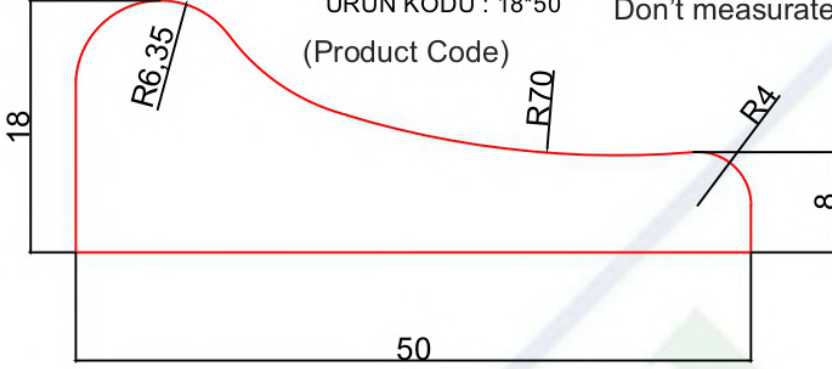

ÜRÜN KODU : 18*70
(Product Code)



ÜRÜN KODU : 36*70
(Product Code)

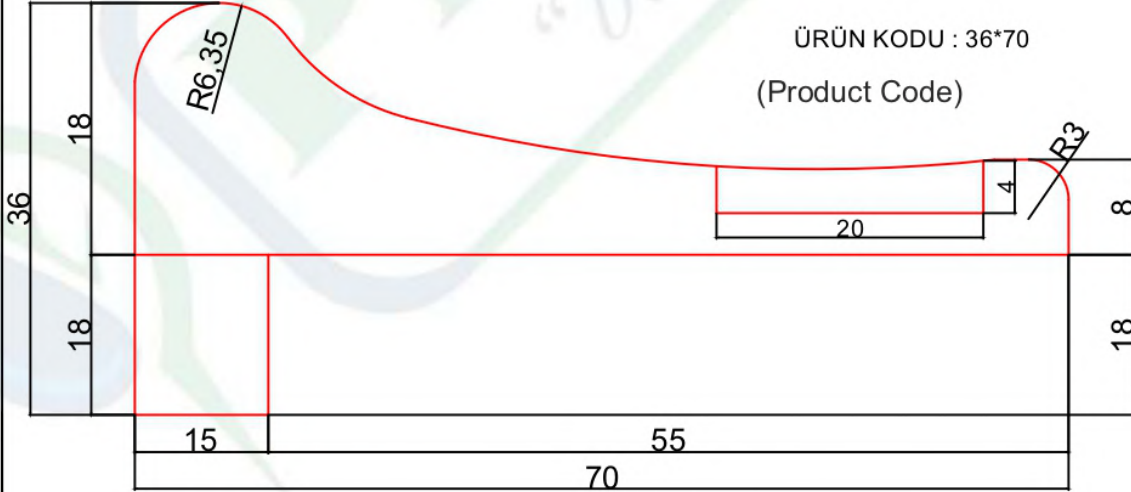

BÖLÜM SORUMLUSU NEJDET ALTINTOPRAK	BU ÇİZİM PROFİLSE - SİLAS ORMAN ÜRÜNLERİ'NE AİTTİR. İZİNSİZ ÇOĞALTILMAMAK VE KOPYA EDİLMEMEK ŞARTI İLE İZİN VERİLMİŞTİR.	PVC ENİ : MDF MİKTARI : PLAKADAN ÇIKAN :	KSM ÖLÇÜCÜ :	KUTU İÇİ : KUTU İÇİ ADET :
ARGE SORUMLUSU DOĞUKAN DEMİR	THIS DRAWING PROFILE - SİLAS FOREST PRODUCTS WHAT TO DO. UNLOCKED AND COPY NOT ALLOWED WITH THE WRITTEN.	GENEL TOLERANS : PROFİL BOY TOLERANSI :	MATERİYAL MM MDF	TARİH / DATE 28.11.2018

18 mm Profiles

PROFİLSE - SİLAS ORMAN ÜRÜNLERİ

KAĞIT ÜZERİNDEN ÖLÇÜ ALMAYINIZ !!!

Don't measurate on paper.

ÜRÜN KODU : 18*35

(Product Code)

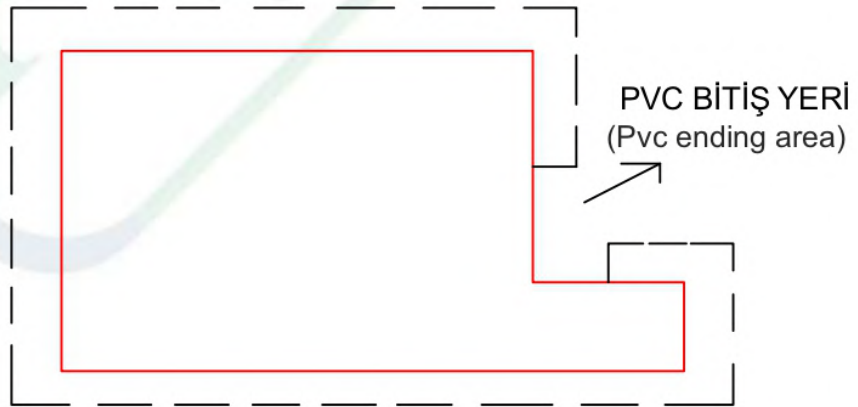
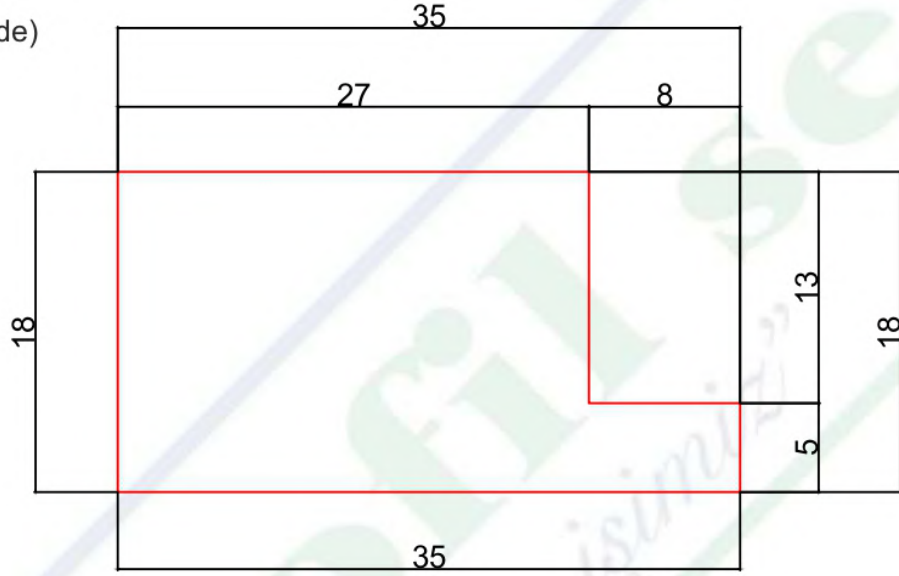

BÖLÜM SORUMLUSU NEJDET ALTINTOPRAK	BU ÇİZİM PROFİLSE - SİLAS ORMAN ÜRÜNLERİ'NE AİTTİR. İZINSİZ ÇOĞALTILMAMAK VE KOPYA EDİLMEMEK ŞARTI İLE İZİN VERİLMİŞTİR.	PVC ENİ : MDF MİKTARI : PLAKADAN ÇIKAN :	KSM ÖLÇÜCÜ :	KUTU İÇİ : KUTU İÇİ ADET :
ARGE SORUMLUSU DOĞUKAN DEMİR	THIS DRAWING PROFILE - SİLAS FOREST PRODUCTS WHAT TO DO. UNLOCKED AND COPY NOT ALLOWED WITH THE WRITTEN.	GENEL TOLERANS : PROFİL BOY TOLERANSI :	MATERİYAL MM MDF	TARİH / DATE 04.10.2018

18 mm Profiles

PROFİLSE - SİLAS ORMAN ÜRÜNLERİ

KAĞIT ÜZERİNDEN ÖLÇÜ ALMAYINIZ !!!
Don't measure on paper.

ÜRÜN KODU : 18*30

(Product Code)

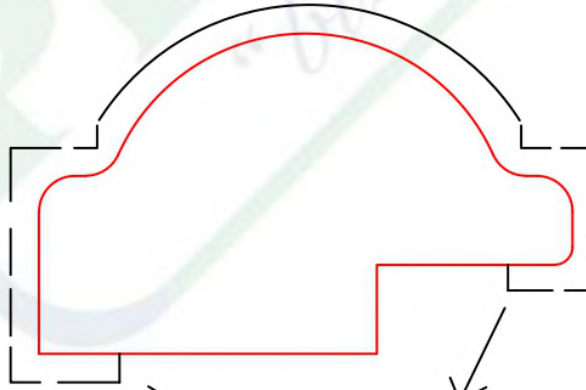
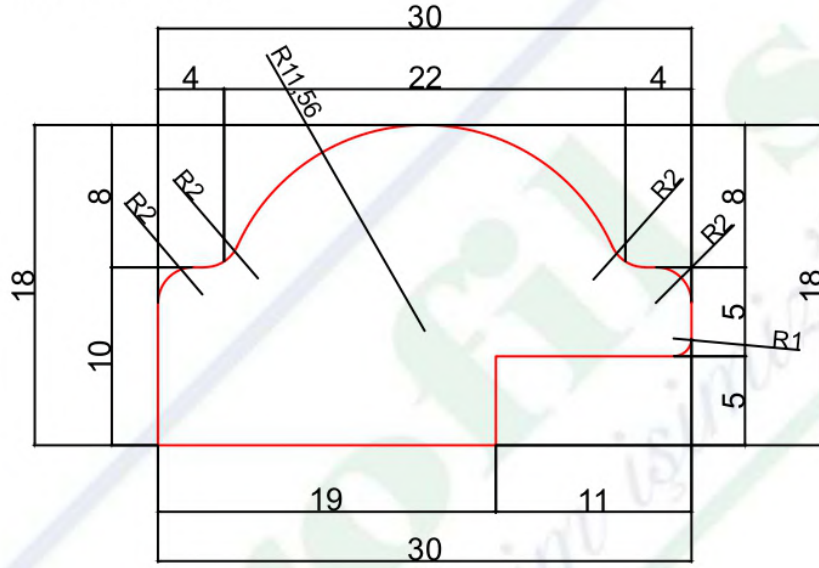

PVC BİTİŞ YERİ

(Pvc ending area)

BÖLÜM SORUMLUSU NEJDET ALTINTOPRAK	BU ÇİZİM PROFİLSE - SİLAS ORMAN ÜRÜNLERİ'NE AİTTİR. İZINSİZ ÇOĞALTILMAMAK VE KOPYA EDİLMEMEK ŞARTI İLE İZİN VERİLMİŞTİR.	PVC ENİ : MDF MİKTARI : PLAKADAN ÇIKAN :	KSM ÖLÇÜCÜ :	KUTU İÇİ : KUTU İÇİ ADET :
ARGE SORUMLUSU DOĞUKAN DEMİR	THIS DRAWING PROFILE - SİLAS FOREST PRODUCTS WHAT TO DO. UNLOCKED AND COPY NOT ALLOWED WITH THE WRITTEN.	GENEL TOLERANS : PROFİL BOY TOLERANSI :	MATERİYAL MM MDF	TARİH / DATE 18.01.2019

18 mm Profiles

PROFİLSE - SİLAS ORMAN ÜRÜNLERİ

KAĞIT ÜZERİNDEN ÖLÇÜ ALMAYINIZ !!!
Don't measurate on paper.

ÜRÜN KODU : 18*20-14

(Product Code)

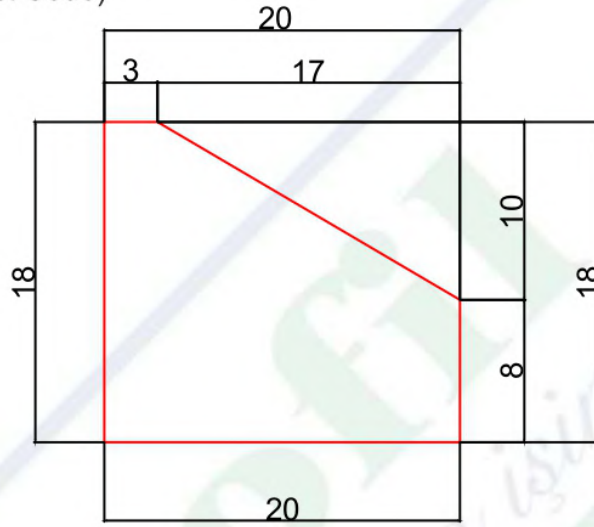

PVC BİTİŞ YERİ
(Pvc ending area)

BÖLÜM SORUMLUSU NEJDET ALTINTOPRAK	BU ÇİZİM PROFİLSE - SİLAS ORMAN ÜRÜNLERİ'NE AİTTİR. İZİNSİZ ÇOĞALTILMAMAK VE KOPYA EDİLMEMEK ŞARTI İLE İZİN VERİLMİŞTİR.	PVC ENİ : MDF MİKTARI : PLAKADAN ÇIKAN :	KSM ÖLÇÜCÜ :	KUTU İÇİ : KUTU İÇİ ADET :
ARGE SORUMLUSU DOĞUKAN DEMİR	THIS DRAWING PROFILE - SILAS FOREST PRODUCTS WHAT TO DO. UNLOCKED AND COPY NOT ALLOWED WITH THE WRITTEN.	GENEL TOLERANS : PROFİL BOY TOLERANSI :	MATERİYAL MM MDF	TARİH / DATE 18.01.2019

18 mm Profiles

PROFİLSE - SİLAS ORMAN ÜRÜNLERİ

KAĞIT ÜZERİNDEN ÖLÇÜ ALMAYINIZ !!!
Don't measure on paper.

ÜRÜN KODU : 18*80

(Product Code)

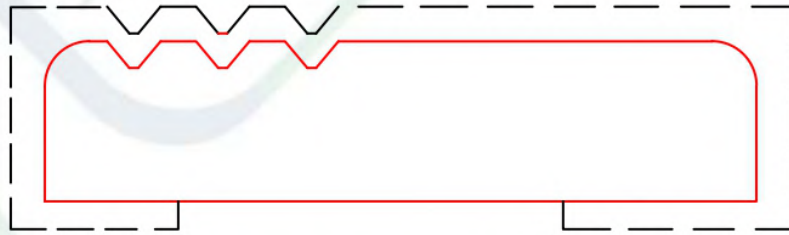
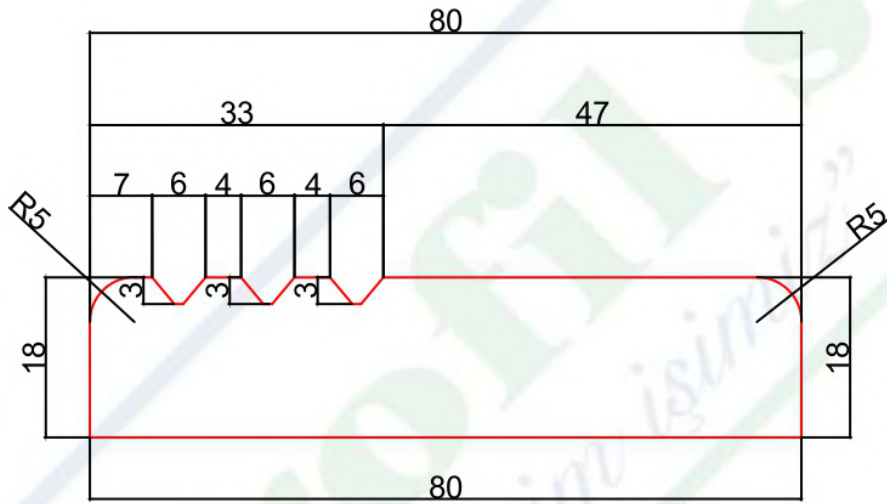

PVC BİTİŞ YERİ
(Pvc ending area)

BÖLÜM SORUMLUSU NEJDET ALTINTOPRAK	BU ÇİZİM PROFİLSE - SİLAS ORMAN ÜRÜNLERİ'NE AİTTİR. İZİNSİZ ÇOĞALTILMAMAK VE KOPYA EDİLMEMEK ŞARTI İLE İZİN VERİLMİŞTİR.	PVC ENİ : MDF MİKTARI : PLAKADAN ÇIKAN :	KSM ÖLÇÜCÜ :	KUTU İÇİ : KUTU İÇİ ADET :
ARGE SORUMLUSU DOĞUKAN DEMİR	THIS DRAWING PROFILE - SİLAS FOREST PRODUCTS WHAT TO DO. UNLOCKED AND COPY NOT ALLOWED WITH THE WRITTEN.	GENEL TOLERANS : PROFİL BOY TOLERANSI :	MATERİYAL MM MDF	TARİH / DATE 19.11.2018

18 mm Profiles

PROFİLSE - SİLAS ORMAN ÜRÜNLERİ

KAĞIT ÜZERİNDEN ÖLÇÜ ALMAYINIZ !!!

Don't measurate on paper.

ÜRÜN KODU : 18*47

(Product Code)

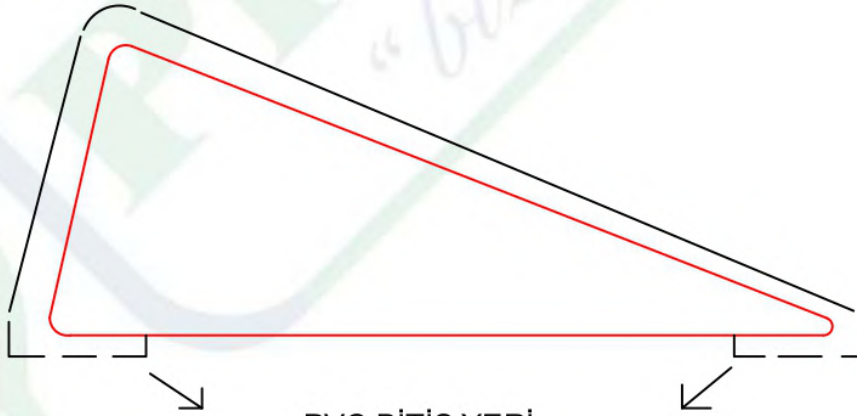
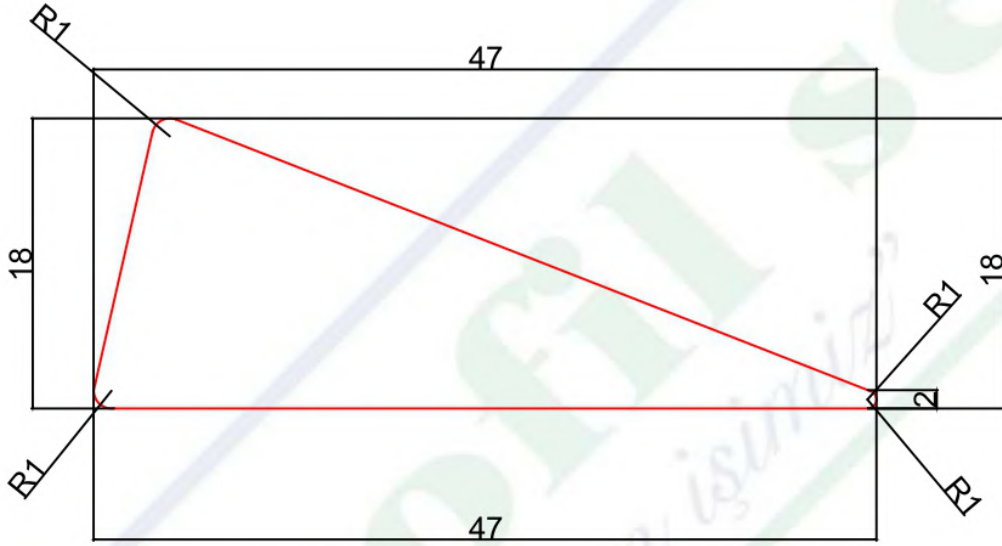

PVC BİTİŞ YERİ

(Pvc ending area)

BÖLÜM SORUMLUSU NEJDET ALTINTOPRAK	BU ÇİZİM PROFİLSE - SİLAS ORMAN ÜRÜNLERİ'NE AİTTİR. İZİNSİZ ÇOĞALTILMAMAK VE KOPYA EDİLMEMEK ŞARTI İLE İZİN VERİLMİŞTİR.	PVC ENİ : MDF MİKTARI : PLAKADAN ÇIKAN :	KSM ÖLÇÜCÜ :	KUTU İÇİ : KUTU İÇİ ADET :
ARGE SORUMLUSU DOĞUKAN DEMİR	THIS DRAWING PROFILE - SİLAS FOREST PRODUCTS WHAT TO DO. UNLOCKED AND COPY NOT ALLOWED WITH THE WRITTEN.	GENEL TOLERANS : PROFİL BOY TOLERANSI :	MATERIAL MM MDF	TARİH / DATE 19.11.2018

18 mm Profiles

PROFİLSE - SİLAS ORMAN ÜRÜNLERİ

KAĞIT ÜZERİNDEN ÖLÇÜ ALMAYINIZ !!!
Don't measure on paper.

ÜRÜN KODU : 18*80
(Product Code)

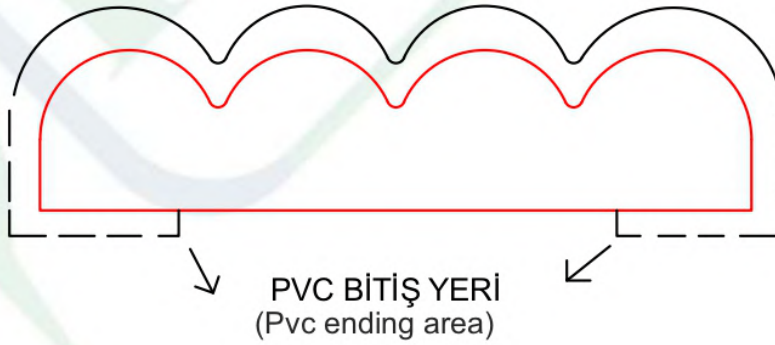
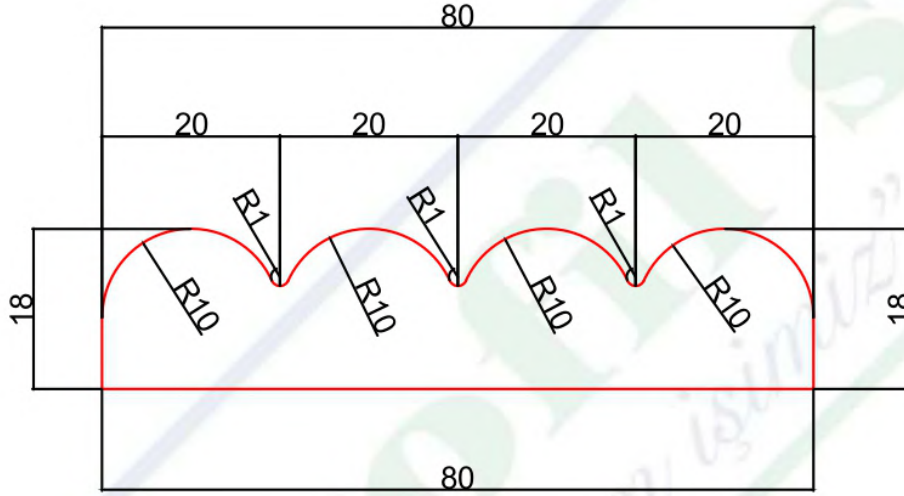

BÖLÜM SORUMLUSU NEJDET ALTINTOPRAK	BU ÇİZİM PROFİLSE - SİLAS ORMAN ÜRÜNLERİ'NE AİTTİR. İZİNSİZ ÇOĞALTILMAMAK VE KOPYA EDİLMEMEK ŞARTI İLE İZİN VERİLMİŞTİR.	PVC ENİ : MDF MİKTARI : PLAKADAN ÇIKAN :	KSM ÖLÇÜCÜ :	KUTU İÇİ : KUTU İÇİ ADET :
ARGE SORUMLUSU DOĞUKAN DEMİR	THIS DRAWING PROFILE - SİLAS FOREST PRODUCTS WHAT TO DO. UNLOCKED AND COPY NOT ALLOWED WITH THE WRITTEN.	GENEL TOLERANS : PROFİL BOY TOLERANSI :	MATERİYAL MM MDF	TARİH / DATE 19.11.2018

18 mm Profiles

PROFİLSE - SİLAS ORMAN ÜRÜNLERİ

KAĞIT ÜZERİNDEN ÖLÇÜ ALMAYINIZ !!!
Don't measure on paper.

ÜRÜN KODU : 18*40
(Product Code)

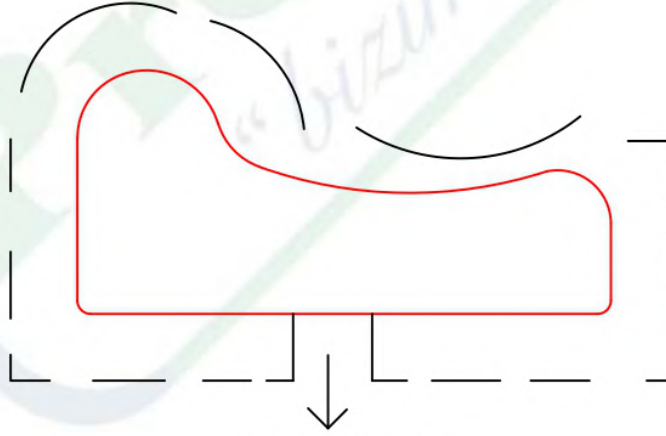
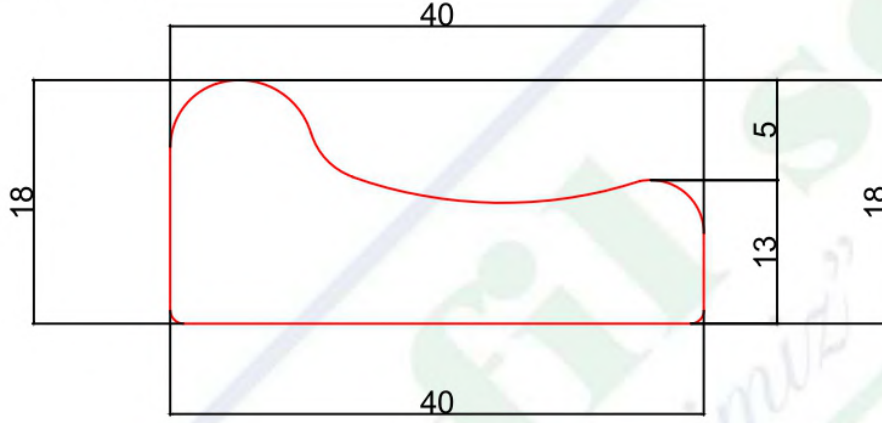

PVC BİTİŞ YERİ
(Pvc ending area)

BÖLÜM SORUMLUSU NEJDET ALTINTOPRAK	BU ÇİZİM PROFİLSE - SİLAS ORMAN ÜRÜNLERİ'NE AİTTİR. İZINSİZ ÇOĞALTILMAMAK VE KOPYA EDİLMEKEMEK ŞARTI İLE İZİN VERİLMİŞTİR.	PVC ENİ : MDF MİKTARI : PLAKADAN ÇIKAN :	KSM ÖLÇÜCÜ :	KUTU İÇİ : KUTU İÇİ ADET :
ARGE SORUMLUSU DOĞUKAN DEMİR	THIS DRAWING PROFILE - SİLAS FOREST PRODUCTS WHAT TO DO. UNLOCKED AND COPY NOT ALLOWED WITH THE WRITTEN.	GENEL TOLERANS : PROFL BOY TOLERANSI :	MATERIAL MM MDF	TARİH / DATE 04.10.2018

18 mm Profiles

PROFİLSE - SİLAS ORMAN ÜRÜNLERİ

KAĞIT ÜZERİNDEN ÖLÇÜ ALMAYINIZ !!!
Don't measure on paper.

ÜRÜN KODU : 18*70-01
(Product Code)

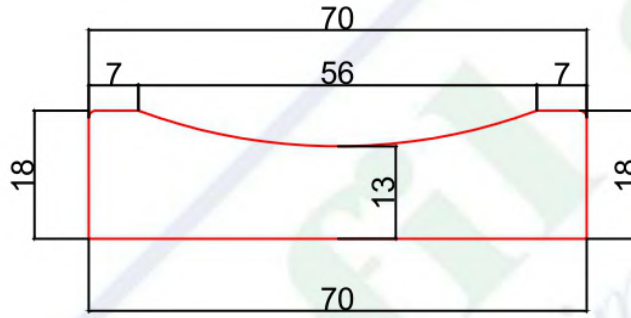

PVC BİTİŞ YERİ
(Pvc ending area)

BÖLÜM SORUMLUSU NEJDET ALTINTOPRAK	BU ÇİZİM PROFİLSE - SİLAS ORMAN ÜRÜNLERİ'NE AİTTİR. İZİNSİZ ÇOĞALTILMAMAK VE KOPYA EDİLMEMEK ŞARTI İLE İZİN VERİLMİŞTİR.	PVC ENİ : MDF MİKTARI : PLAKADAN ÇIKAN :	KSM ÖLÇÜCÜ :	KUTU İÇİ : KUTU İÇİ ADET :
ARGE SORUMLUSU DOĞUKAN DEMİR	THIS DRAWING PROFILE - SİLAS FOREST PRODUCTS WHAT TO DO. UNLOCKED AND COPY NOT ALLOWED WITH THE WRITTEN.	GENEL TOLERANS : PROFİL BOY TOLERANSI :	MATERİYAL MM MDF	TARİH / DATE 04.10.2018

18 mm Profiles

PROFİLSE - SİLAS ORMAN ÜRÜNLERİ

KAĞIT ÜZERİNDEN ÖLÇÜ ALMAYINIZ !!!
Don't measurate on paper.

ÜRÜN KODU : 18*18
(Product Code)

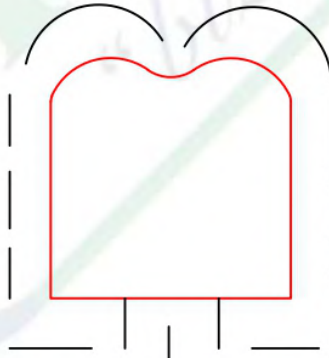
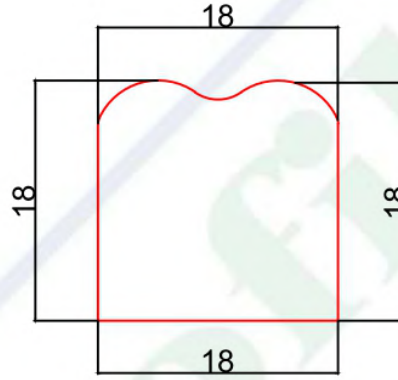

PVC BİTİŞ YERİ
(Pvc ending area)

BÖLÜM SORUMLUSU NEJDET ALTINTOPRAK	BU ÇİZİM PROFİLSE - SİLAS ORMAN ÜRÜNLERİ'NE AİTTİR. İZINSİZ ÇOĞALTILMAMAK VE KOPYA EDİLMEKEMEK ŞARTI İLE İZİN VERİLMİŞTİR.	PVC ENİ : MDF MİKTARI : PLAKADAN ÇIKAN :	KSM ÖLÇÜCÜ :	KUTU İÇİ : KUTU İÇİ ADET :
ARGE SORUMLUSU DOĞUKAN DEMİR	THIS DRAWING PROFILE - SİLAS FOREST PRODUCTS WHAT TO DO. UNLOCKED AND COPY NOT ALLOWED WITH THE WRITTEN.	GENEL TOLERANS : PROFİL BOY TOLERANSI :	MATERİYAL MM MDF	TARİH / DATE 04.10.2018

18 mm Profiles

PROFİLSE - SİLAS ORMAN ÜRÜNLERİ

KAĞIT ÜZERİNDEN ÖLÇÜ ALMAYINIZ !!!
Don't measure on paper.

ÜRÜN KODU : 18*18-01

(Product Code)

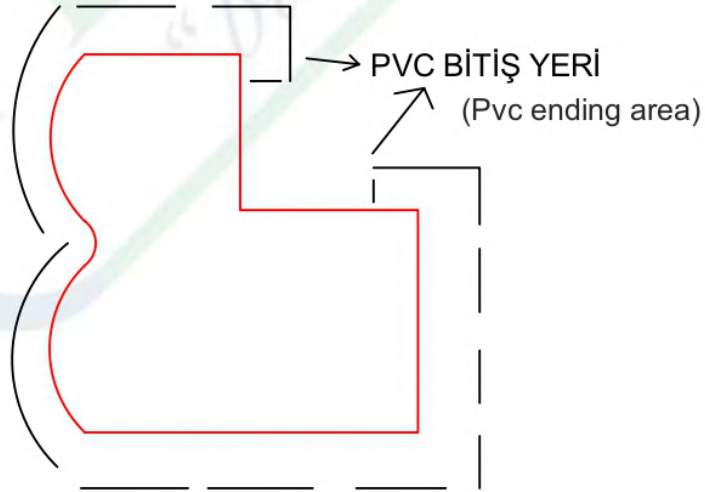
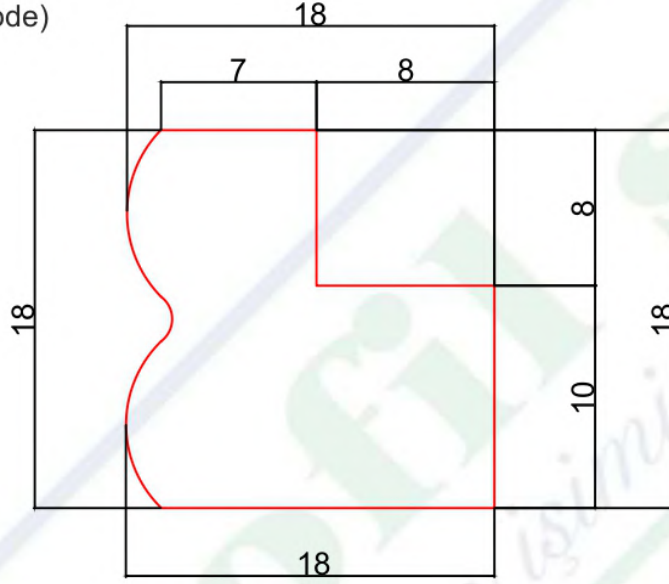

BÖLÜM SORUMLUSU NEJDET ALTINTOPRAK	BU ÇİZİM PROFİLSE - SİLAS ORMAN ÜRÜNLERİ'NE AİTTİR. İZİNSİZ ÇOĞALTILMAMAK VE KOPYA EDİLMEMEK ŞARTI İLE İZİN VERİLMİŞTİR.	PVC ENİ : MDF MİKTARI : PLAKADAN ÇIKAN :	KSM ÖLÇÜCÜ :	KUTU İÇİ : KUTU İÇİ ADET :
ARGE SORUMLUSU DOĞUKAN DEMİR	THIS DRAWING PROFILE - SİLAS FOREST PRODUCTS WHAT TO DO. UNLOCKED AND COPY NOT ALLOWED WITH THE WRITTEN.	GENEL TOLERANS : PROFİL BOY TOLERANSI :	MATERIAL MM MDF	TARİH / DATE 04.10.2018

18 mm Profiles

PROFİLSE - SİLAS ORMAN ÜRÜNLERİ

KAĞIT ÜZERİNDEN ÖLÇÜ ALMAYINIZ !!!
Don't measure on paper.

ÜRÜN KODU : 18*50
(Product Code)

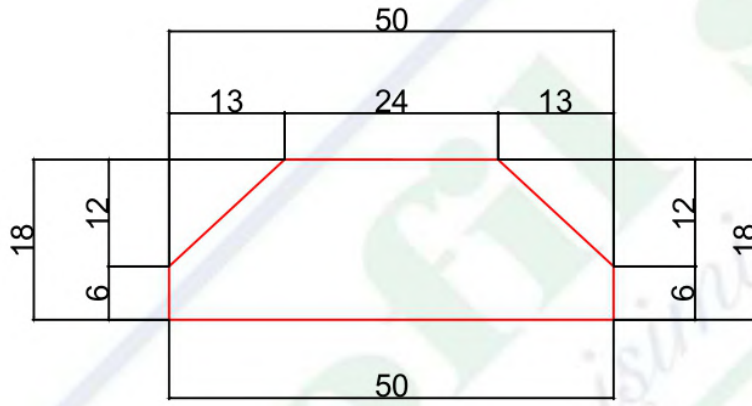

(Pvc ending area)
PVC BİTİŞ YERİ

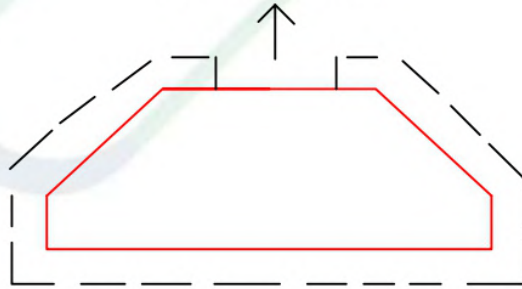

BÖLÜM SORUMLUSU NEJDET ALTINTOPRAK	BU ÇİZİM PROFİLSE - SİLAS ORMAN ÜRÜNLERİ'NE AİTTİR. İZINSİZ ÇOĞALTILMAMAK VE KOPYA EDİLMEK ŞARTI İLE İZİN VERİLMİŞTİR.	PVC ENİ : MDF MİKTARI : PLAKADAN ÇIKAN :	KSM ÖLÇÜCÜ :	KUTU İÇİ : KUTU İÇİ ADET :
ARGE SORUMLUSU DOĞUKAN DEMİR	THIS DRAWING PROFILE - SILAS FOREST PRODUCTS WHAT TO DO. UNLOCKED AND COPY NOT ALLOWED WITH THE WRITTEN.	GENEL TOLERANS : PROFİL BOY TOLERANSI :	MATERİYAL MM MDF	TARİH / DATE 04.10.2018

18 mm Profiles

PROFİLSE - SİLAS ORMAN ÜRÜNLERİ

KAĞIT ÜZERİNDEN ÖLÇÜ ALMAYINIZ !!!
Don't measure on paper.

ÜRÜN KODU : 18*50
(Product Code)

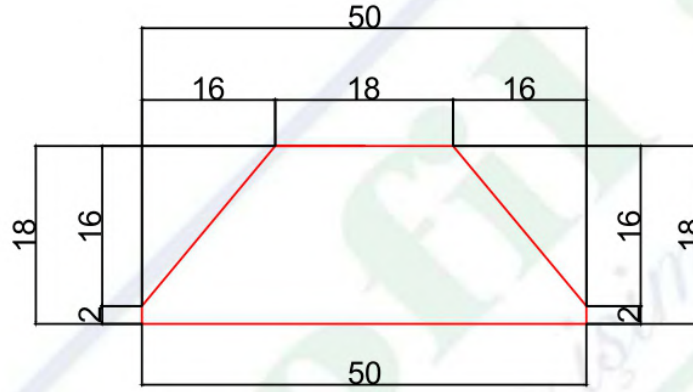

(Pvc ending area)
PVC BİTİŞ YERİ

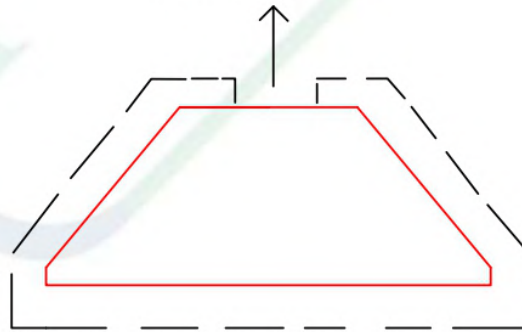

BÖLÜM SORUMLUSU NEJDET ALTINTOPRAK	BU ÇİZİM PROFİLSE - SİLAS ORMAN ÜRÜNLERİ'NE AİTTİR. İZİNSİZ ÇOĞALTILMAMAK VE KOPYA EDİLMEMEK ŞARTI İLE İZİN VERİLMİŞTİR.	PVC ENİ : MDF MİKTARI : PLAKADAN ÇIKAN :	KSM ÖLÇÜCÜ :	KUTU İÇİ : KUTU İÇİ ADET :
ARGE SORUMLUSU DOĞUKAN DEMİR	THIS DRAWING PROFILE - SİLAS FOREST PRODUCTS WHAT TO DO. UNLOCKED AND COPY NOT ALLOWED WITH THE WRITTEN.	GENEL TOLERANS : PROFİL BOY TOLERANSI :	MATERİYAL MM MDF	TARİH / DATE 04.10.2018

18 mm Profiles

PROFİLSE - SİLAS ORMAN ÜRÜNLERİ

KAĞIT ÜZERİNDEN ÖLÇÜ ALMAYINIZ !!!

Don't measurate on paper.

ÜRÜN KODU : 18*67

(Product Code)

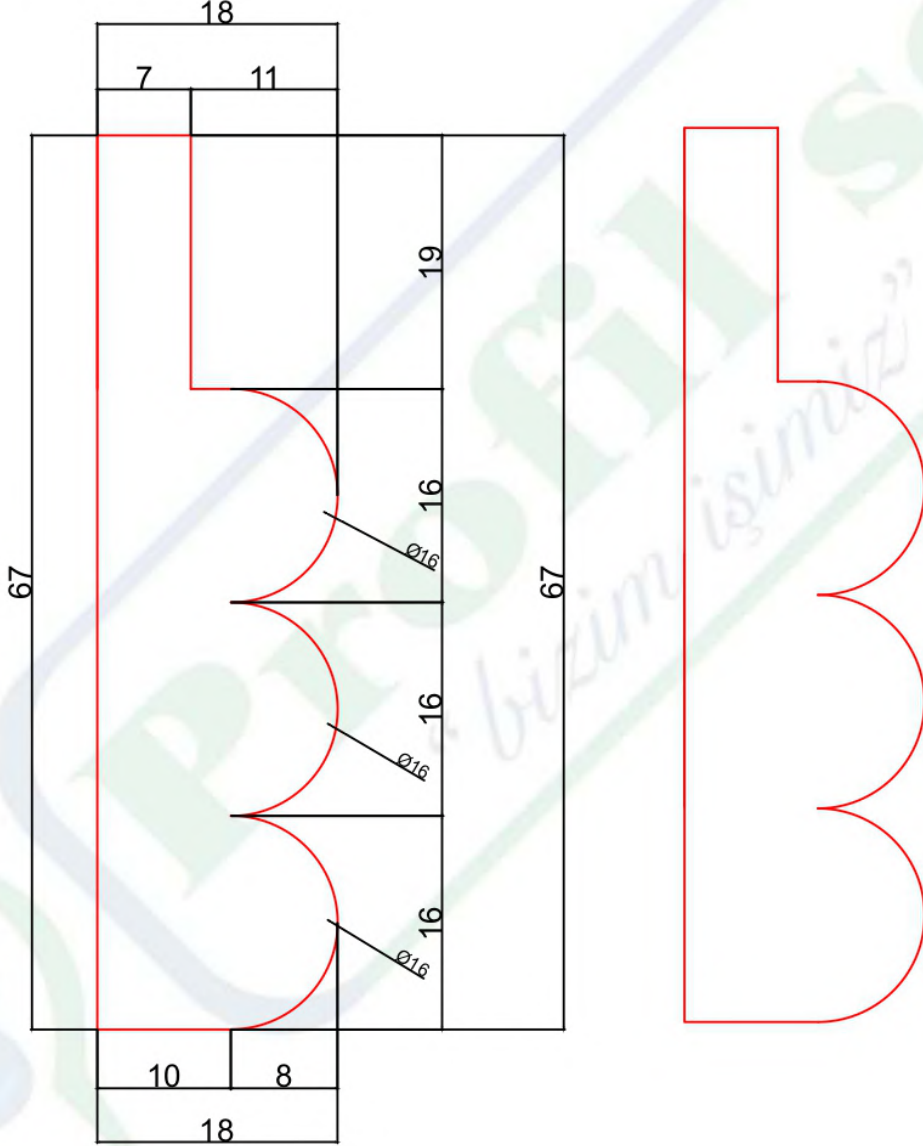

BÖLÜM SORUMLUSU NEJDET ALTINTOPRAK	BU ÇİZİM PROFİLSE - SİLAS ORMAN ÜRÜNLERİ'NE AİTTİR. İZINSİZ ÇOĞALTILMAMAK VE KOPYA EDİLMEKEMEK ŞARTI İLE İZİN VERİLMİŞTİR.	PVC ENİ : MDF MİKTARI : PLAKADAN ÇIKAN :	KSM ÖLÇÜCÜ :	KUTU İÇİ : KUTU İÇİ ADET :
ARGE SORUMLUSU DOĞUKAN DEMİR	THIS DRAWING PROFILE - SİLAS FOREST PRODUCTS WHAT TO DO. UNLOCKED AND COPY NOT ALLOWED WITH THE WRITTEN.	GENEL TOLERANS : PROFİL BOY TOLERANSI :	MATERİYAL MM MDF	TARİH / DATE 25.12.2018

18 mm Profiles

PROFİLSE - SİLAS ORMAN ÜRÜNLERİ

KAĞIT ÜZERİNDEN ÖLÇÜ ALMAYINIZ !!!
Don't measurate on paper.

ÜRÜN KODU : 18*32
(Product Code)

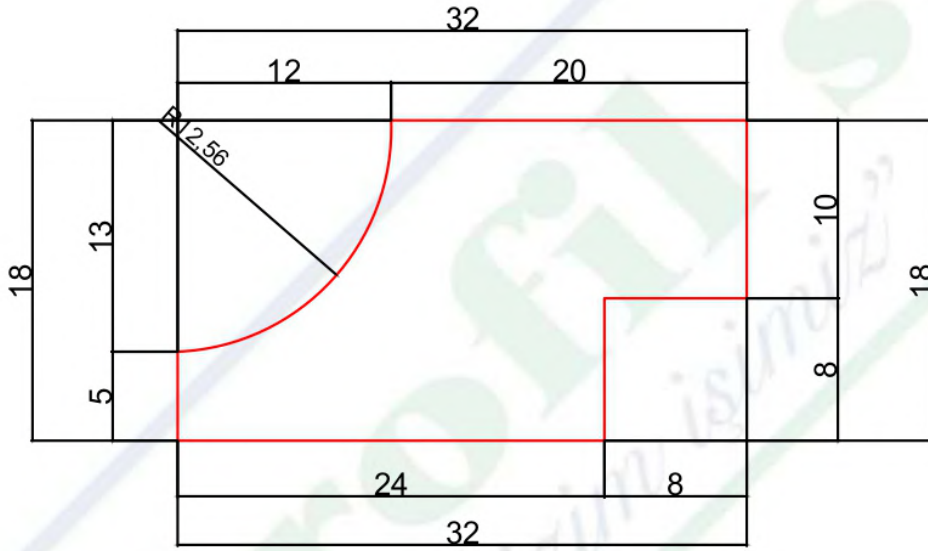

BÖLÜM SORUMLUSU NEJDET ALTINTOPRAK	BU ÇİZİM PROFİLSE - SİLAS ORMAN ÜRÜNLERİ'NE AİTTİR. İZINSİZ ÇOĞALTILMAMAK VE KOPYA EDİLMEYEMEK ŞARTI İLE İZİN VERİLMİŞTİR.	PVC ENİ : MDF MİKTARI : PLAKADAN ÇIKAN :	KSM ÖLÇÜCÜ :	KUTU İÇİ : KUTU İÇİ ADET :
ARGE SORUMLUSU DOĞUKAN DEMİR	THIS DRAWING PROFILE - SİLAS FOREST PRODUCTS WHAT TO DO. UNLOCKED AND COPY NOT ALLOWED WITH THE WRITTEN.	GENEL TOLERANS : PROFİL BOY TOLERANSI :	MATERİYAL MM MDF	TARİH / DATE 16.04.2019

18 mm Profiles

PROFİLSE - SİLAS ORMAN ÜRÜNLERİ

KAĞIT ÜZERİNDEN ÖLÇÜ ALMAYINIZ !!!
Don't measurate on paper.

ÜRÜN KODU : 18*32

(Product Code)

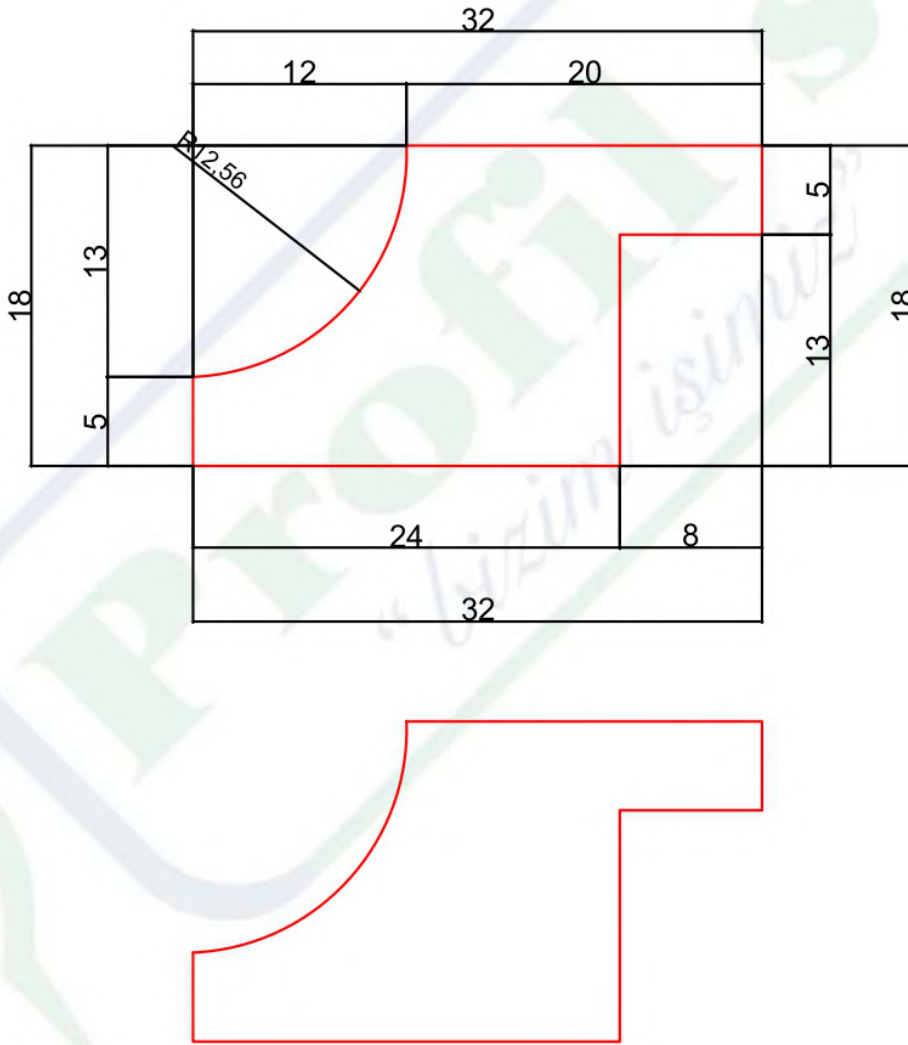

BÖLÜM SORUMLUSU NEJDET ALTINTOPRAK	BU ÇİZİM PROFİLSE - SİLAS ORMAN ÜRÜNLERİ'NE AITTİR. İZINSİZ ÇOĞALTILMAMAK VE KOPYA EDİLMEMEK ŞARTI İLE İZİN VERİLMİŞTİR.	PVC ENİ : MDF MİKTARI : PLAKADAN ÇIKAN :	KSM ÖLÇÜCÜ :	KUTU İÇİ : KUTU İÇİ ADET :
ARGE SORUMLUSU DOĞUKAN DEMİR	THIS DRAWING PROFILE - SİLAS FOREST PRODUCTS WHAT TO DO. UNLOCKED AND COPY NOT ALLOWED WITH THE WRITTEN.	GENEL TOLERANS : PROFİL BOY TOLERANSI :	MATERİYAL MM MDF	TARİH / DATE 16.04.2019

18 mm Profiles

PROFİLSE - SİLAS ORMAN ÜRÜNLERİ

KAĞIT ÜZERİNDEN ÖLÇÜ ALMAYINIZ !!!
Don't measure on paper.

ÜRÜN KODU : 18*68

(Product Code)

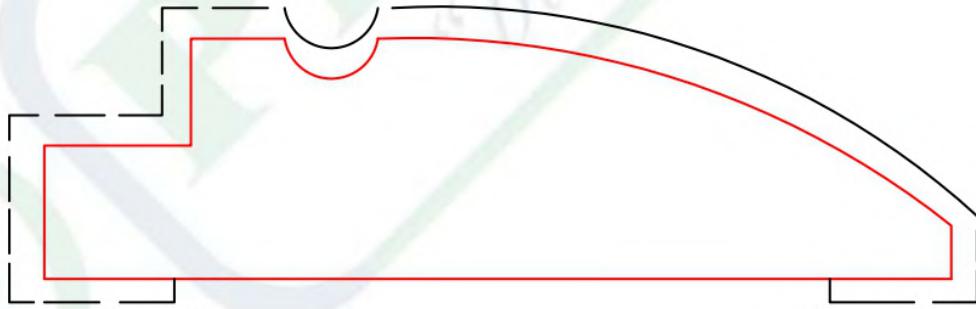
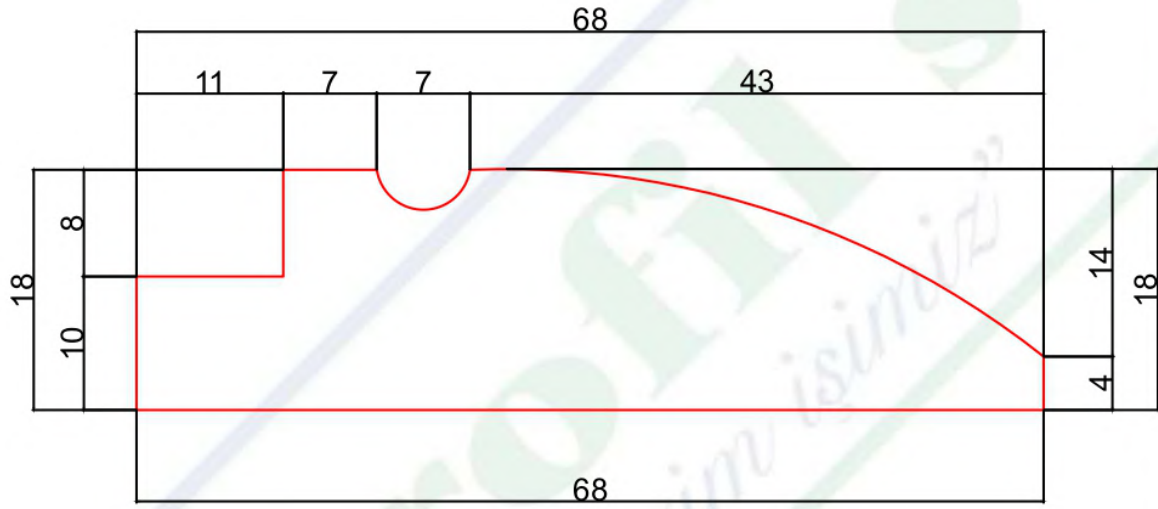

PVC BİTİŞ YERİ
(Pvc ending area)

BÖLÜM SORUMLUSU NEJDET ALTINTOPRAK	BU ÇİZİM PROFİLSE - SİLAS ORMAN ÜRÜNLERİ'NE AİTTİR. İZİNSİZ ÇOĞALTILMAMAK VE KOPYA EDİLMEKEMEK ŞARTI İLE İZİN VERİLMİŞTİR.	PVC ENİ : MDF MİKTARI : PLAKADAN ÇIKAN :	KSM ÖLÇÜCÜ :	KUTU İÇİ : KUTU İÇİ ADET :
ARGE SORUMLUSU DOĞUKAN DEMİR	THIS DRAWING PROFILE - SİLAS FOREST PRODUCTS WHAT TO DO. UNLOCKED AND COPY NOT ALLOWED WITH THE WRITTEN.	GENEL TOLERANS : PROFİL BOY TOLERANSI :	MATERIAL MM MDF	TARİH / DATE 11.04.2019

18 mm Profiles

PROFİLSE - SİLAS ORMAN ÜRÜNLERİ

KAĞIT ÜZERİNDEN ÖLÇÜ ALMAYINIZ !!!
Don't measurate on paper.

ÜRÜN KODU : 18*26

(Product Code)

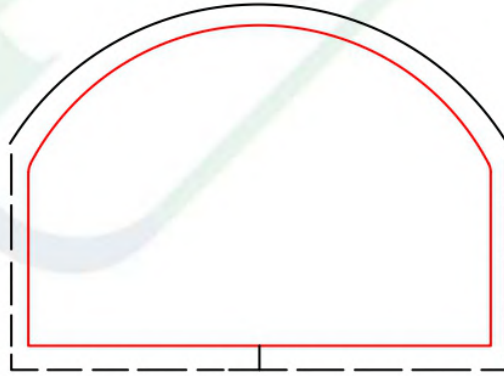
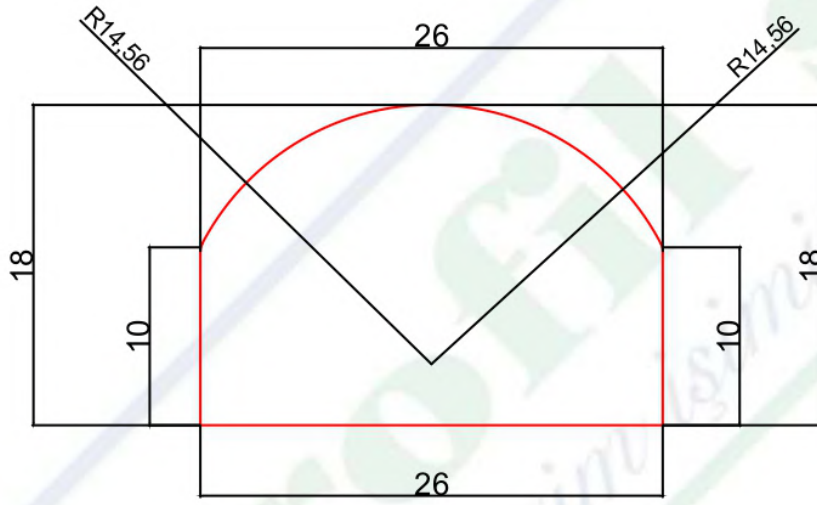

↓ Pvc Coated all of them
PVC BİTİŞ YERİ - TAM KAPLI

BÖLÜM SORUMLUSU NEJDET ALTINTOPRAK	BU ÇİZİM PROFİLSE - SİLAS ORMAN ÜRÜNLERİ'NE AİTTİR. İZINSİZ ÇOĞALTILMAMAK VE KOPYA EDİLMEMEK ŞARTI İLE İZİN VERİLMİŞTİR.	PVC ENİ : MDF MİKTARI : PLAKADAN ÇIKAN :	KSM ÖLÇÜCÜ :	KUTU İÇİ : KUTU İÇİ ADET :
ARGE SORUMLUSU DOĞUKAN DEMİR	THIS DRAWING PROFILE - SİLAS FOREST PRODUCTS WHAT TO DO. UNLOCKED AND COPY NOT ALLOWED WITH THE WRITTEN.	GENEL TOLERANS : PROFİL BOY TOLERANSI :	MATERIAL MM MDF	TARİH / DATE 16.04.2019

18 mm Profiles

PROFİLSE - SİLAS ORMAN ÜRÜNLERİ

KAĞIT ÜZERİNDEN ÖLÇÜ ALMAYINIZ !!!
Don't measure on paper.

ÜRÜN KODU : 18*100
(Product Code)

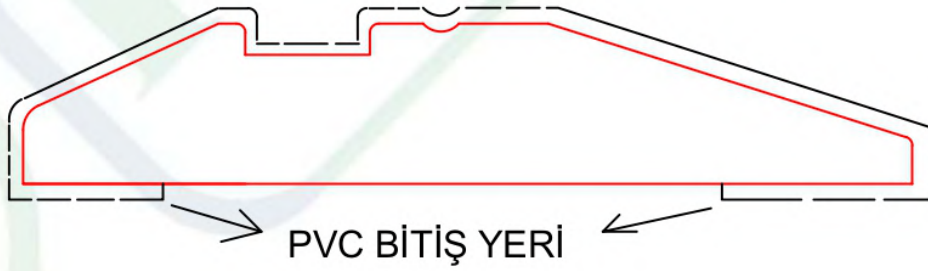
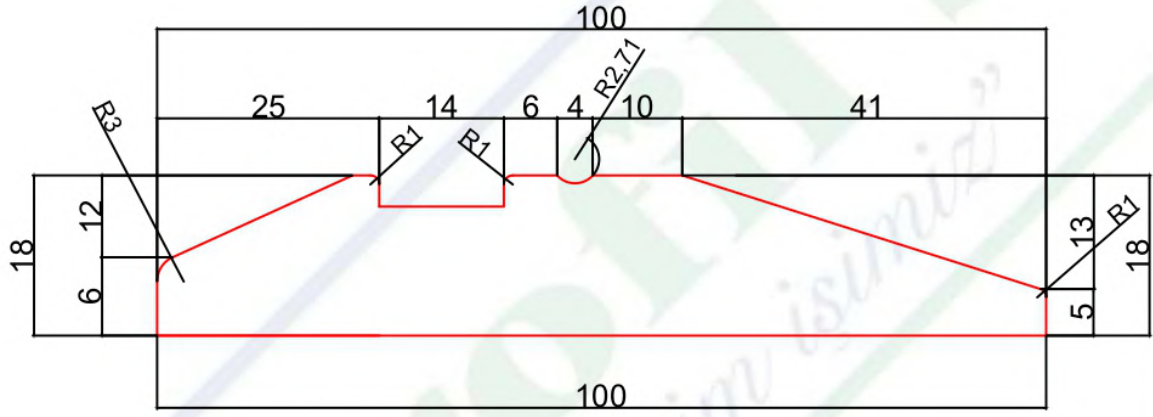

(Pvc ending area)

BÖLÜM SORUMLUSU NEJDET ALTINTOPRAK	BU ÇİZİM PROFİLSE - SİLAS ORMAN ÜRÜNLERİ'NE AİTTİR. İZİNSİZ ÇOĞALTILMAMAK VE KOPYA EDİLMEMEK ŞARTI İLE İZİN VERİLMİŞTİR.	PVC ENİ : MDF MİKTARI : PLAKADAN ÇIKAN :	KSM ÖLÇÜCÜ :	KUTU İÇİ : KUTU İÇİ ADET :
ARGE SORUMLUSU DOĞUKAN DEMİR	THIS DRAWING PROFILE - SİLAS FOREST PRODUCTS WHAT TO DO. UNLOCKED AND COPY NOT ALLOWED WITH THE WRITTEN.	GENEL TOLERANS : PROFL BOY TOLERANSI :	MATERİYAL MM MDF	TARİH / DATE 03.04.2019

18 mm Profiles

PROFİLSE - SİLAS ORMAN ÜRÜNLERİ

KAĞIT ÜZERİNDEN ÖLÇÜ ALMAYINIZ !!!
Don't measurate on paper.

ÜRÜN KODU : 18*25
(Product Code)

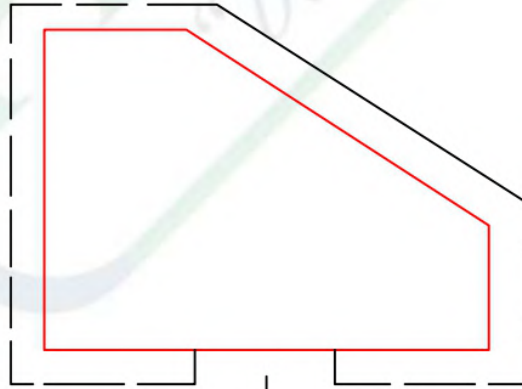
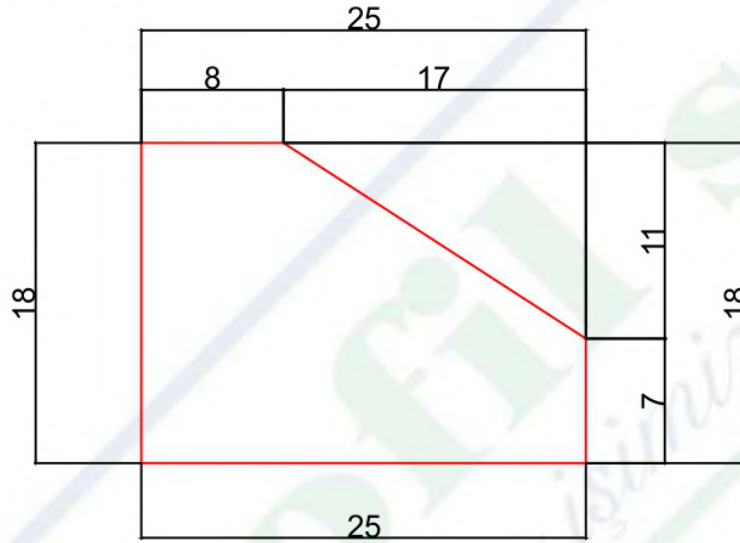

PVC BİTİŞ YERİ
(Pvc ending area)

BÖLÜM SORUMLUSU NEJDET ALTINTOPRAK	BU ÇİZİM PROFİLSE - SİLAS ORMAN ÜRÜNLERİ'NE AİTTİR. İZINSİZ ÇOĞALTILMAMAK VE KOPYA EDİLMEMEK ŞARTI İLE İZİN VERİLMİŞTİR.	PVC ENİ : MDF MİKTARI : PLAKADAN ÇIKAN :	KSM ÖLÇÜCÜ :	KUTU İÇİ : KUTU İÇİ ADET :
ARGE SORUMLUSU DOĞUKAN DEMİR	THIS DRAWING PROFILE - SILAS FOREST PRODUCTS WHAT TO DO. UNLOCKED AND COPY NOT ALLOWED WITH THE WRITTEN.	GENEL TOLERANS : PROFL BOY TOLERANSI :	MATERİAL MM MDF	TARİH / DATE 03.04.2019

18 mm Profiles

PROFİLSE - SİLAS ORMAN ÜRÜNLERİ

KAĞIT ÜZERİNDEN ÖLÇÜ ALMAYINIZ !!!

Don't measurate on paper.

ÜRÜN KODU : 18*27

(Product Code)

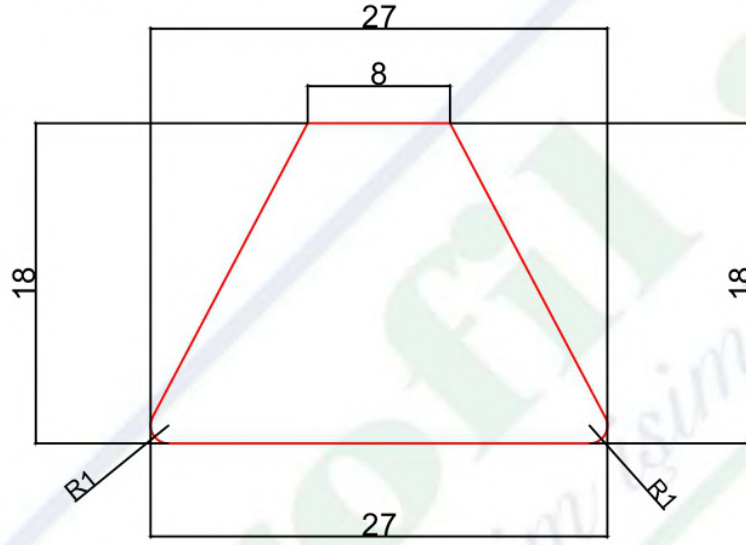

(Pvc ending area)

PVC BİTİŞ YERİ

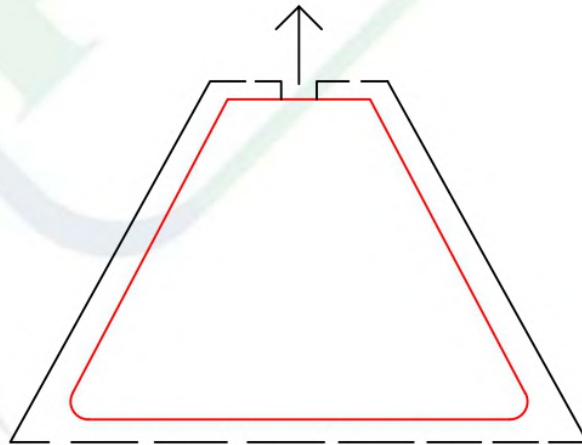

BÖLÜM SORUMLUSU NEJDET ALTINTOPRAK	BU ÇİZİM PROFİLSE - SİLAS ORMAN ÜRÜNLERİ'NE AİTTİR. İZİNSİZ ÇOĞALTILMAMAK VE KOPYA EDİLMEMEK ŞARTI İLE İZİN VERİLMİŞTİR.	PVC ENİ : MDF MİKTARI : PLAKADAN ÇIKAN :	KSM ÖLÇÜCÜ :	KUTU İÇİ : KUTU İÇİ ADET :
ARGE SORUMLUSU DOĞUKAN DEMİR	THIS DRAWING PROFILE - SİLAS FOREST PRODUCTS WHAT TO DO. UNLOCKED AND COPY NOT ALLOWED WITH THE WRITTEN.	GENEL TOLERANS : PROFİL BOY TOLERANSI :	MATERİYAL MM MDF	TARİH / DATE 04.04.2019

18 mm Profiles

PROFİLSE - SİLAS ORMAN ÜRÜNLERİ

KAĞIT ÜZERİNDEN ÖLÇÜ ALMAYINIZ !!!
Don't measurate on paper.

ÜRÜN KODU : 18*18

(Product Code)

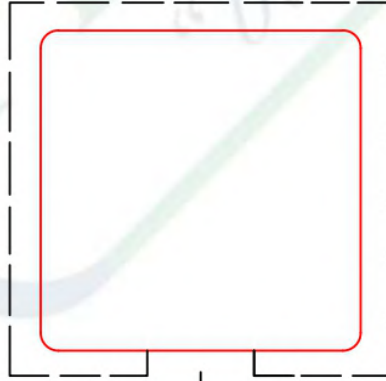
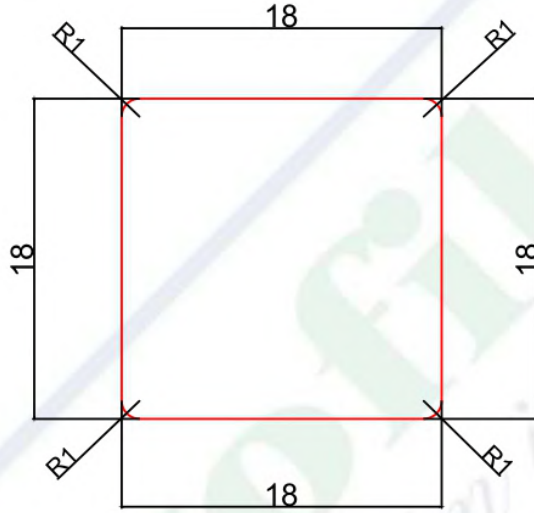

PVC BİTİŞ YERİ
(Pvc ending area)

BÖLÜM SORUMLUSU NEJDET ALTINTOPRAK	BU ÇİZİM PROFİLSE - SİLAS ORMAN ÜRÜNLERİ'NE AİTTİR. İZINSİZ ÇOĞALTILMAMAK VE KOPYA EDİLMEK ŞARTI İLE İZİN VERİLMİŞTİR.	PVC ENİ : MDF MİKTARI : PLAKADAN ÇIKAN :	KSM ÖLÇÜCÜ :	KUTU İÇİ : KUTU İÇİ ADET :
ARGE SORUMLUSU DOĞUKAN DEMİR	THIS DRAWING PROFILE - SİLAS FOREST PRODUCTS WHAT TO DO. UNLOCKED AND COPY NOT ALLOWED WITH THE WRITTEN.	GENEL TOLERANS : PROFL BOY TOLERANSI :	MATERİAL MM MDF	TARİH / DATE 04.04.2019

18 mm Profiles

PROFİLSE - SİLAS ORMAN ÜRÜNLERİ

KAĞIT ÜZERİNDEN ÖLÇÜ ALMAYINIZ !!!

Don't measurate on paper.

ÜRÜN KODU : 18*18

(Product Code)

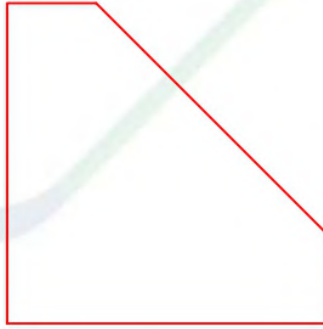
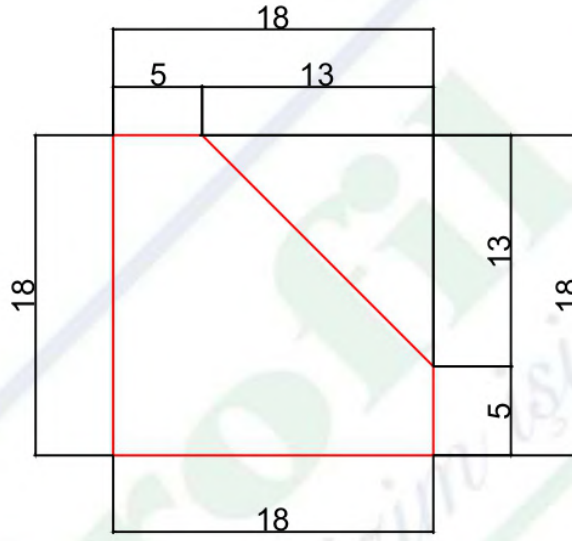

BÖLÜM SORUMLUSU NEJDET ALTINTOPRAK	BU ÇİZİM PROFİLSE - SİLAS ORMAN ÜRÜNLERİ'NE AİTTİR. İZINSİZ ÇOĞALTILMAMAK VE KOPYA EDİLMEK ŞARTI İLE İZİN VERİLMİŞTİR.	PVC ENİ : MDF MİKTARI : PLAKADAN ÇIKAN :	KSM ÖLÇÜCÜ :	KUTU İÇİ : KUTU İÇİ ADET :
ARGE SORUMLUSU DOĞUKAN DEMİR	THIS DRAWING PROFILE - SILAS FOREST PRODUCTS WHAT TO DO. UNLOCKED AND COPY NOT ALLOWED WITH THE WRITTEN.	GENEL TOLERANS : PROFİL BOY TOLERANSI :	MATERİYAL MM MDF	TARİH / DATE 28.03.2019

18 mm Profiles

PROFİLSE - SİLAS ORMAN ÜRÜNLERİ

KAĞIT ÜZERİNDEN ÖLÇÜ ALMAYINIZ !!!

Don't measurate on paper.

ÜRÜN KODU : 18*36

(Product Code)

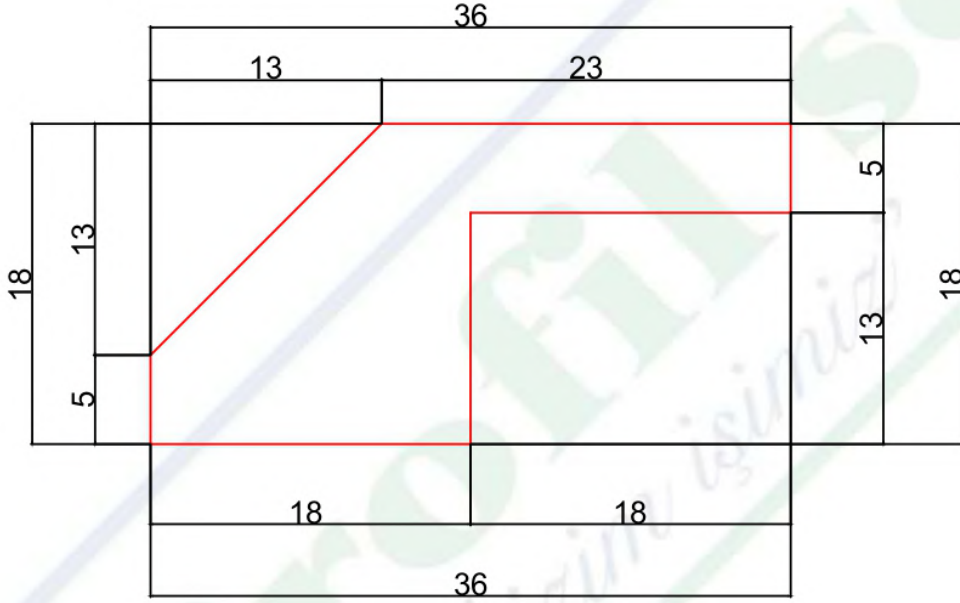

BÖLÜM SORUMLUSU NEJDET ALTINTOPRAK	BU ÇİZİM PROFİLSE - SİLAS ORMAN ÜRÜNLERİ'NE AİTTİR. İZINSİZ ÇOĞALTILMAMAK VE KOPYA EDİLMEMEK ŞARTI İLE İZİN VERİLMİŞTİR.	PVC ENİ : MDF MİKTARI : PLAKADAN ÇIKAN :	KSM ÖLÇÜCÜ :	KUTU İÇİ : KUTU İÇİ ADET :
ARGE SORUMLUSU DOĞUKAN DEMİR	THIS DRAWING PROFILE - SİLAS FOREST PRODUCTS WHAT TO DO. UNLOCKED AND COPY NOT ALLOWED WITH THE WRITTEN.	GENEL TOLERANS : PROFİL BOY TOLERANSI :	MATERİYAL MM MDF	TARİH / DATE 28.03.2019

18 mm Profiles

PROFİLSE - SİLAS ORMAN ÜRÜNLERİ

KAĞIT ÜZERİNDEN ÖLÇÜ ALMAYINIZ !!!
Don't measure on paper.

ÜRÜN KODU : 18*70
(Product Code)

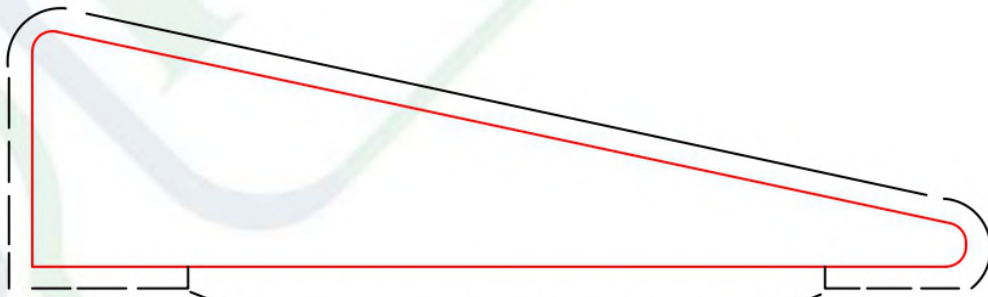
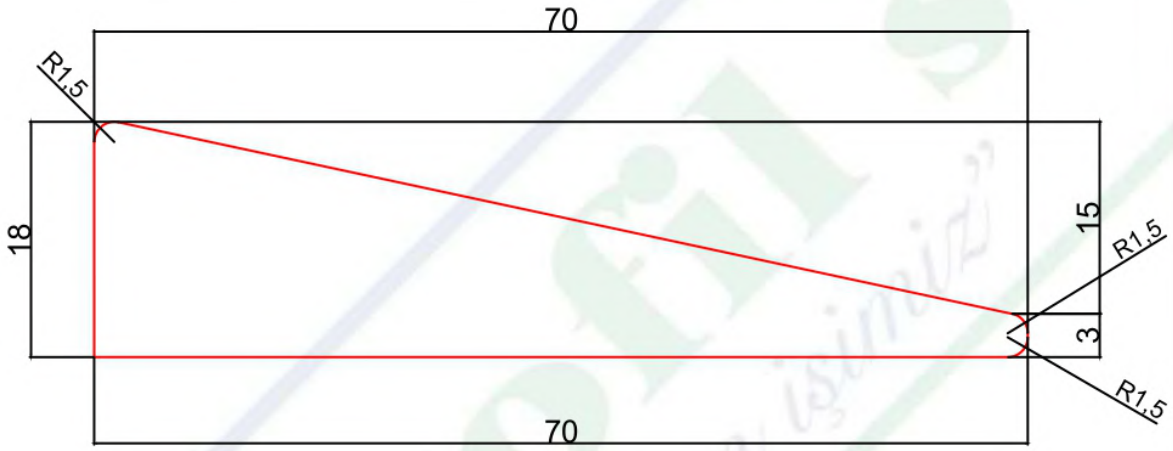

PVC BİTİŞ YERİ

(Pvc ending area)

BÖLÜM SORUMLUSU NEJDET ALTINTOPRAK	BU ÇİZİM PROFİLSE - SİLAS ORMAN ÜRÜNLERİ'NE AİTTİR. İZINSİZ ÇOĞALTILMAMAK VE KOPYA EDİLMEMEK ŞARTI İLE İZİN VERİLMİŞTİR.	PVC ENİ : MDF MİKTARI : PLAKADAN ÇIKAN :	KSM ÖLÇÜCÜ :	KUTU İÇİ : KUTU İÇİ ADET :
ARGE SORUMLUSU DOĞUKAN DEMİR	THIS DRAWING PROFILE - SİLAS FOREST PRODUCTS WHAT TO DO. UNLOCKED AND COPY NOT ALLOWED WITH THE WRITTEN.	GENEL TOLERANS : PROFİL BOY TOLERANSI :	MATERİYAL MM MDF	TARİH / DATE 08.03.2019

18 mm Profiles

PROFİLSE - SİLAS ORMAN ÜRÜNLERİ

KAĞIT ÜZERİNDEN ÖLÇÜ ALMAYINIZ !!!

Don't measurate on paper.

ÜRÜN KODU : 18*30

(Product Code)

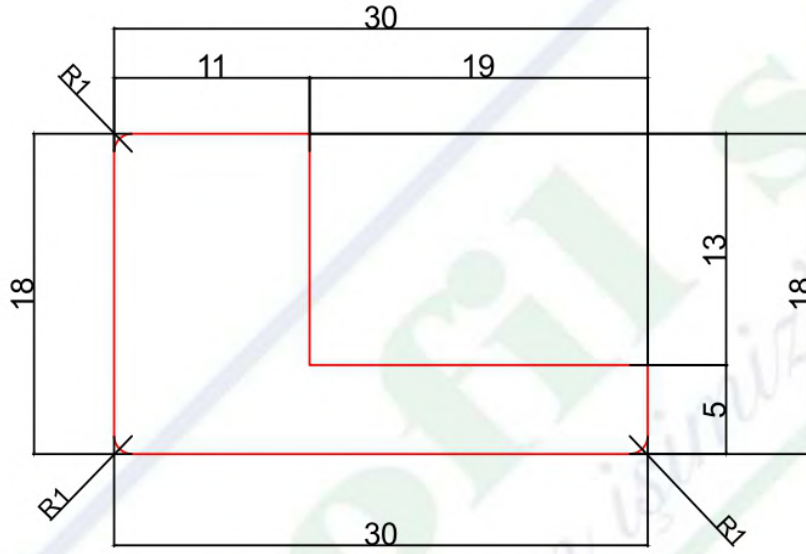

PVC
BİTİŞ
YERİ (Pvc ending area)

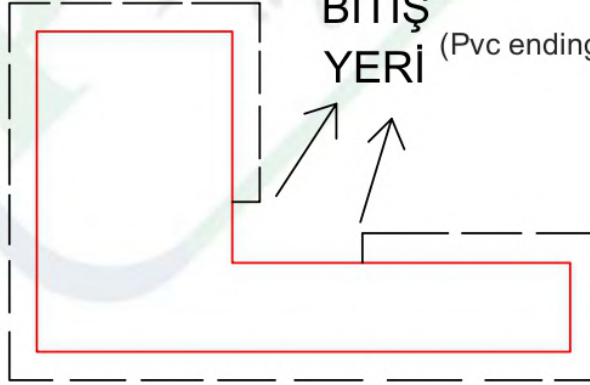

BÖLÜM SORUMLUSU NEJDET ALTINTOPRAK	BU ÇİZİM PROFİLSE - SİLAS ORMAN ÜRÜNLERİ'NE AİTTİR. İZINSİZ ÇOĞALTILMAMAK VE KOPYA EDİLMEKEMEK ŞARTI İLE İZİN VERİLMİŞTİR.	PVC ENİ : MDF MİKTARI : PLAKADAN ÇIKAN :	KSM ÖLÇÜCÜ :	KUTU İÇİ : KUTU İÇİ ADET :
ARGE SORUMLUSU DOĞUKAN DEMİR	THIS DRAWING PROFILE - SİLAS FOREST PRODUCTS WHAT TO DO. UNLOCKED AND COPY NOT ALLOWED WITH THE WRITTEN.	GENEL TOLERANS : PROFL BOY TOLERANSI :	MATERIAL MM MDF	TARİH / DATE 01.03.2019

18 mm Profiles

PROFİLSE - SİLAS ORMAN ÜRÜNLERİ

KAĞIT ÜZERİNDEN ÖLÇÜ ALMAYINIZ !!!

Don't measurate on paper.

ÜRÜN KODU : 18*25
(Product Code)

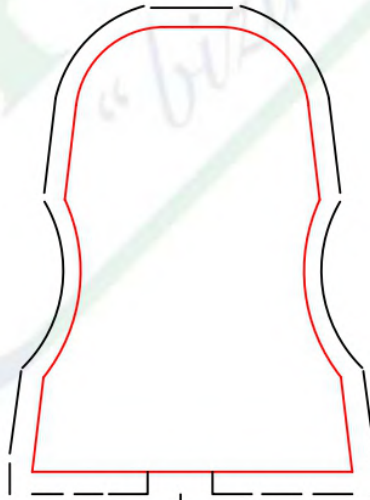
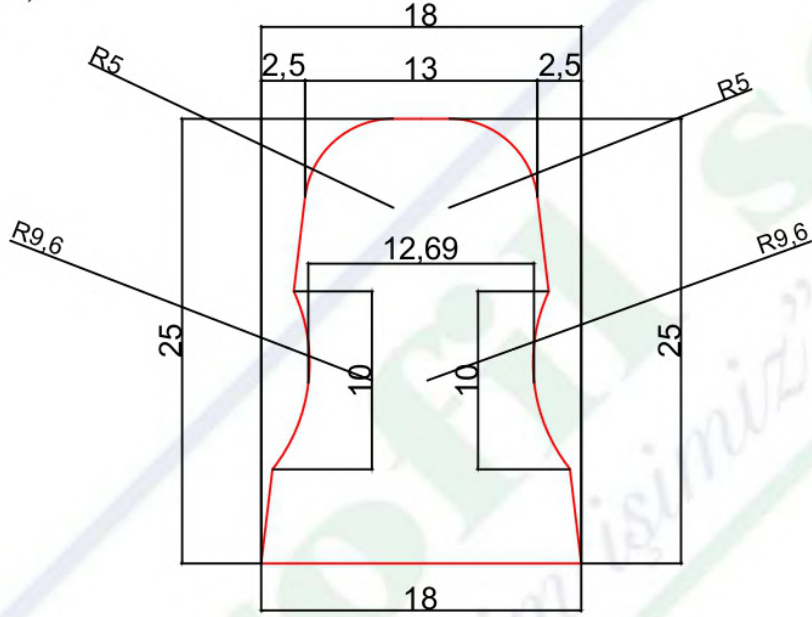

PVC BİTİŞ YERİ
(Pvc ending area)

BÖLÜM SORUMLUSU NEJDET ALTINTOPRAK	BU ÇİZİM PROFİLSE - SİLAS ORMAN ÜRÜNLERİ'NE AİTTİR. İZINSİZ ÇOĞALTILMAMAK VE KOPYA EDİLMEMEK ŞARTI İLE İZİN VERİLMİŞTİR.	PVC ENİ : MDF MİKTARI : PLAKADAN ÇIKAN :	KSM ÖLÇÜCÜ :	KUTU İÇİ : KUTU İÇİ ADET :
ARGE SORUMLUSU DOĞUKAN DEMİR	THIS DRAWING PROFILE - SİLAS FOREST PRODUCTS WHAT TO DO. UNLOCKED AND COPY NOT ALLOWED WITH THE WRITTEN.	GENEL TOLERANS : PROFİL BOY TOLERANSI :	MATERIAL MM MDF	TARİH / DATE 25.01.2019

18 mm Profiles

PROFİLSE - SİLAS ORMAN ÜRÜNLERİ

(Product Code)
ÜRÜN KODU : 18*20-02
BANTLI

KAĞIT ÜZERİNDEN ÖLÇÜ ALMAYINIZ !!!
Don't measurate on paper.

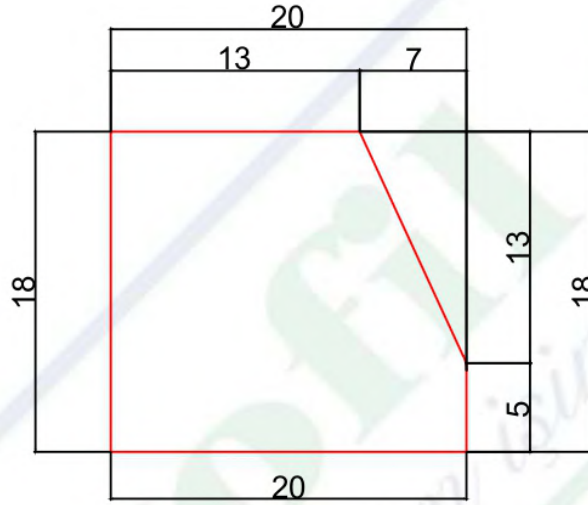

PVC
BİTİŞ
YERİ
(Pvc ending area)

BÖLÜM SORUMLUSU NEJDET ALTINTOPRAK	BU ÇİZİM PROFİLSE - SİLAS ORMAN ÜRÜNLERİ'NE AİTTİR. İZİNSİZ ÇOĞALTILMAMAK VE KOPYA EDİLMEMEK ŞARTI İLE İZİN VERİLMİŞTİR.	PVC ENİ : MDF MİKTARI : PLAKADAN ÇIKAN :	KSM ÖLÇÜCÜ :	KUTU İÇİ : KUTU İÇİ ADET :
ARGE SORUMLUSU DOĞUKAN DEMİR	THIS DRAWING PROFILE - SİLAS FOREST PRODUCTS WHAT TO DO. UNLOCKED AND COPY NOT ALLOWED WITH THE WRITTEN.	GENEL TOLERANS : PROFİL BOY TOLERANSI :	MATERIAL MM MDF	TARİH / DATE 20.06.2019

18 mm Profiles

PROFİLSE - SİLAS ORMAN ÜRÜNLERİ

KAĞIT ÜZERİNDEN ÖLÇÜ ALMAYINIZ !!!

Don't measurate on paper.

ÜRÜN KODU : 18*20-01
BANTSIZ
(Product Code)

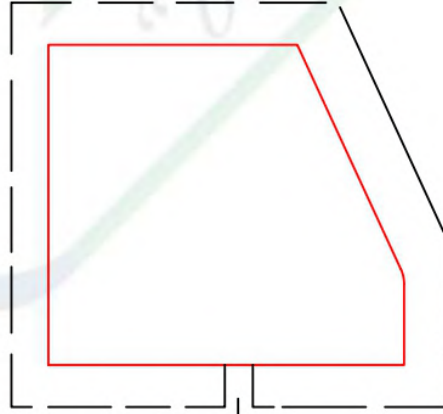
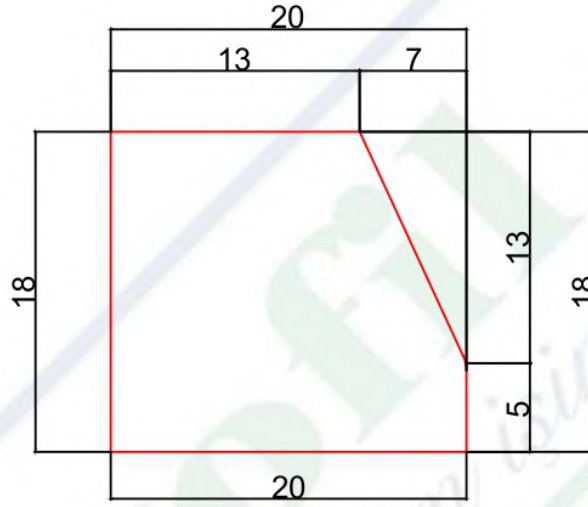

PVC BİTİŞ YERİ
(Pvc ending area)

BÖLÜM SORUMLUSU NEJDET ALTINTOPRAK	BU ÇİZİM PROFİLSE - SİLAS ORMAN ÜRÜNLERİ'NE AİTTİR. İZINSİZ ÇOĞALTILMAMAK VE KOPYA EDİLMEMEK ŞARTI İLE İZİN VERİLMİŞTİR.	PVC ENİ : MDF MİKTARI : PLAKADAN ÇIKAN :	KSM ÖLÇÜCÜ :	KUTU İÇİ : KUTU İÇİ ADET :
ARGE SORUMLUSU DOĞUKAN DEMİR	THIS DRAWING PROFILE - SİLAS FOREST PRODUCTS WHAT TO DO. UNLOCKED AND COPY NOT ALLOWED WITH THE WRITTEN.	GENEL TOLERANS : PROFİL BOY TOLERANSI :	MATERİYAL MM MDF	TARİH / DATE 20.06.2019

18 mm Profiles

PROFİLSE - SİLAS ORMAN ÜRÜNLERİ

KAĞIT ÜZERİNDEN ÖLÇÜ ALMAYINIZ !!!
Don't measure on paper.

ÜRÜN KODU :18*46
(Product Code)

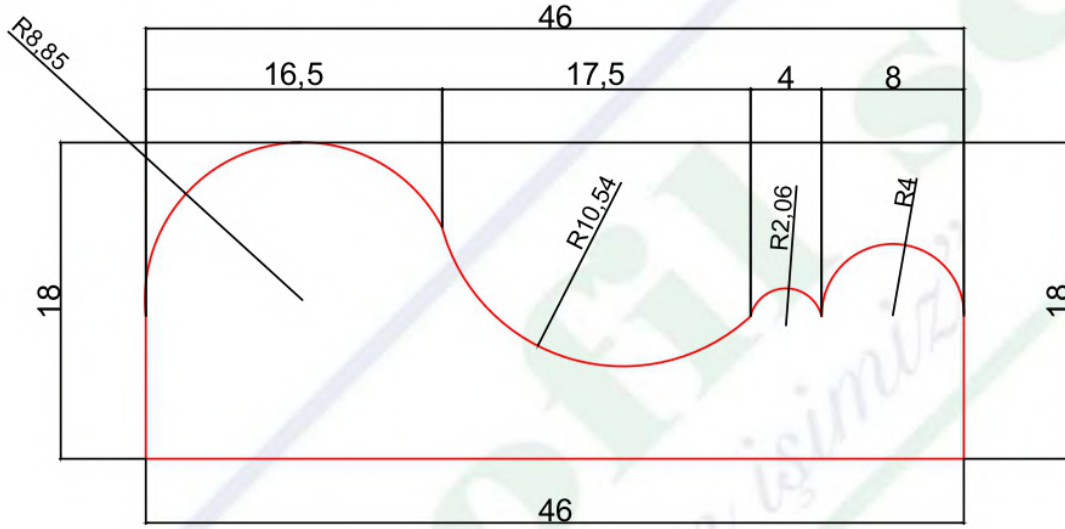

PVC BİTİŞ YERİ
(Pvc ending area)

BÖLÜM SORUMLUSU NEJDET ALTINTOPRAK	BU ÇİZİM PROFİLSE - SİLAS ORMAN ÜRÜNLERİ'NE AİTTİR. İZİNSİZ ÇOĞALTILMAMAK VE KOPYA EDİLMEKEMEK ŞARTI İLE İZİN VERİLMİŞTİR.	PVC ENİ : MDF MİKTARI : PLAKADAN ÇIKAN :	KSM ÖLÇÜCÜ :	KUTU İÇİ : KUTU İÇİ ADET :
ARGE SORUMLUSU DOĞUKAN DEMİR	THIS DRAWING PROFILE - SİLAS FOREST PRODUCTS WHAT TO DO. UNLOCKED AND COPY NOT ALLOWED WITH THE WRITTEN.	GENEL TOLERANS : PROFL BOY TOLERANSI :	MATERİYAL MM MDF	TARİH / DATE 20.02.2019

18 mm Profiles

PROFİLSE - SİLAS ORMAN ÜRÜNLERİ

KAĞIT ÜZERİNDEN ÖLÇÜ ALMAYINIZ !!!
Don't measure on paper.

ÜRÜN KODU : 18*25
(Product Code)

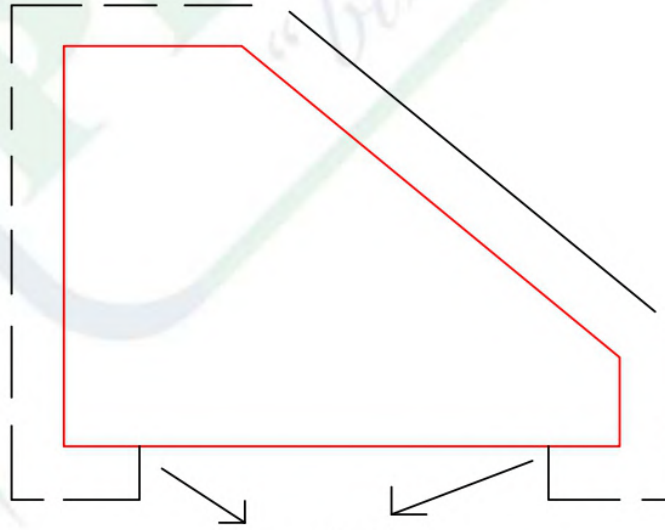
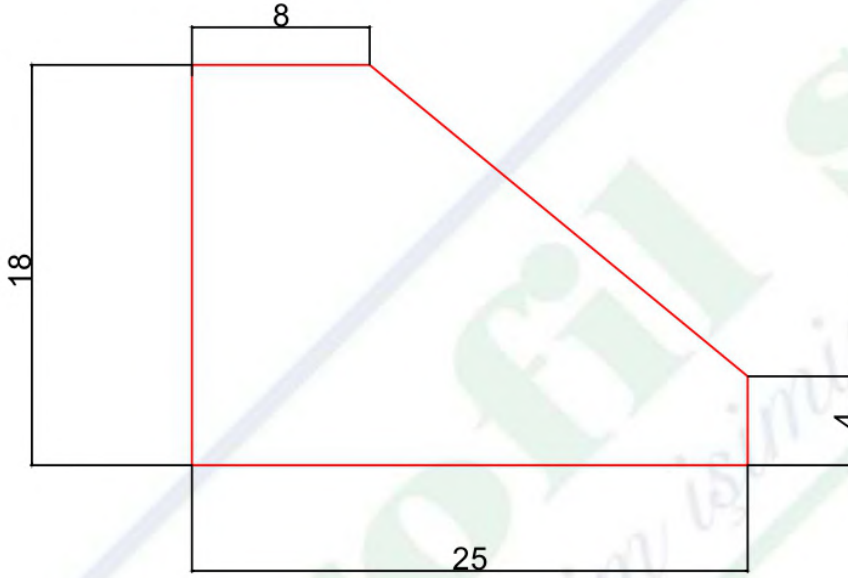

PVC BİTİŞ YERİ
(Pvc ending area)

BÖLÜM SORUMLUSU NEJDET ALTINTOPRAK	BU ÇİZİM PROFİLSE - SİLAS ORMAN ÜRÜNLERİ'NE AITTİR. İZINSİZ ÇOĞALTILMAMAK VE KOPYA EDİLMEMEK ŞARTI İLE İZİN VERİLMİŞTİR.	PVC ENİ : MDF MİKTARI : PLAKADAN ÇIKAN :	KSM ÖLÇÜCÜ :	KUTU İÇİ : KUTU İÇİ ADET :
ARGE SORUMLUSU DOĞUKAN DEMİR	THIS DRAWING PROFILE - SİLAS FOREST PRODUCTS WHAT TO DO. UNLOCKED AND COPY NOT ALLOWED WITH THE WRITTEN.	GENEL TOLERANS : PROFİL BOY TOLERANSI :	MATERİYAL MM MDF	TARİH / DATE 04.10.2018

18 mm Profiles

PROFİLSE - SİLAS ORMAN ÜRÜNLERİ

KAĞIT ÜZERİNDEN ÖLÇÜ ALMAYINIZ !!!

Don't measurate on paper.

ÜRÜN KODU : 18*40-01

(Product Code)

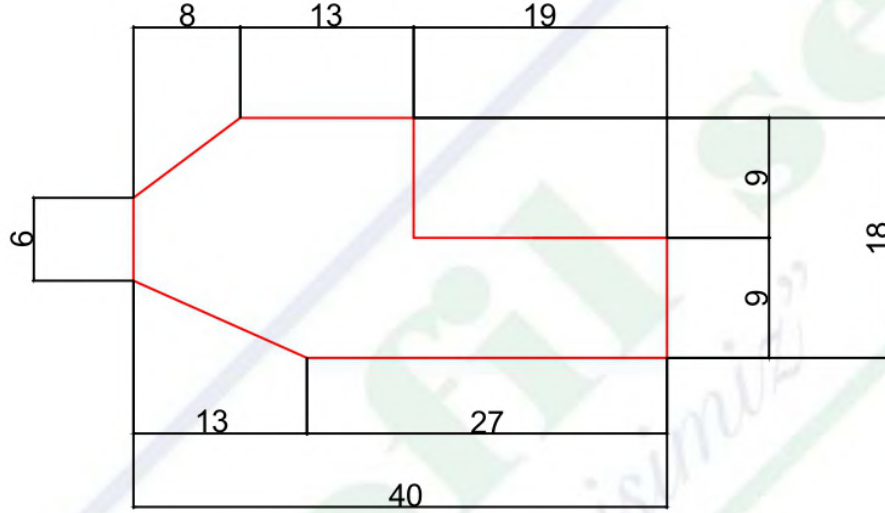

(Pvc ending area)

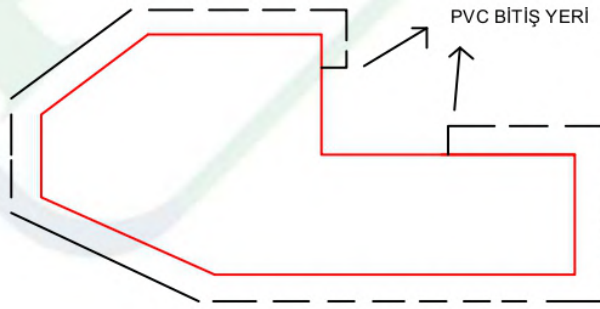

BÖLÜM SORUMLUSU NEJDET ALTINTOPRAK	BU ÇİZİM PROFİLSE - SİLAS ORMAN ÜRÜNLERİ'NE AİTTİR. İZINSİZ ÇOĞALTILMAMAK VE KOPYA EDİLMEMEK ŞARTI İLE İZİN VERİLMİŞTİR.	PVC ENİ : MDF MİKTARI : PLAKADAN ÇIKAN :	KSM ÖLÇÜCÜ :	KUTU İÇİ : KUTU İÇİ ADET :
ARGE SORUMLUSU DOĞUKAN DEMİR	THIS DRAWING PROFILE - SİLAS FOREST PRODUCTS WHAT TO DO. UNLOCKED AND COPY NOT ALLOWED WITH THE WRITTEN.	GENEL TOLERANS : PROFİL BOY TOLERANSI :	MATERİYAL MM MDF	TARİH / DATE 04.10.2018

18 mm Profiles

PROFİLSE - SİLAS ORMAN ÜRÜNLERİ

KAĞIT ÜZERİNDEN ÖLÇÜ ALMAYINIZ !!!

Don't measurate on paper.

ÜRÜN KODU : 18*35

(Product Code)

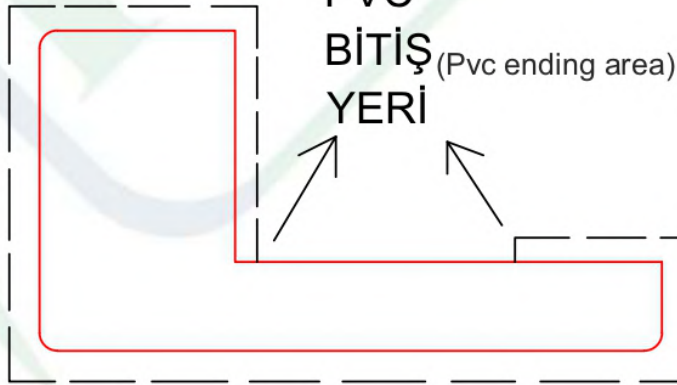
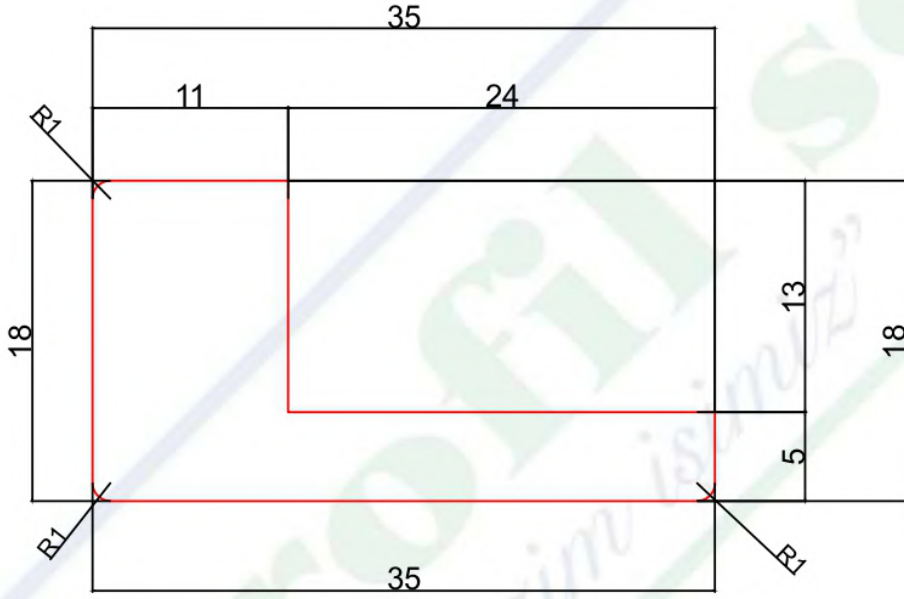

BÖLÜM SORUMLUSU NEJDET ALTINTOPRAK	BU ÇİZİM PROFİLSE - SİLAS ORMAN ÜRÜNLERİ'NE AİTTİR. İZINSİZ ÇOĞALTILMAMAK VE KOPYA EDİLMEYEMEK ŞARTI İLE İZİN VERİLMİŞTİR.	PVC ENİ : MDF MİKTARI : PLAKADAN ÇIKAN :	KSM ÖLÇÜCÜ :	KUTU İÇİ : KUTU İÇİ ADET :
ARGE SORUMLUSU DOĞUKAN DEMİR	THIS DRAWING PROFILE - SİLAS FOREST PRODUCTS WHAT TO DO. UNLOCKED AND COPY NOT ALLOWED WITH THE WRITTEN.	GENEL TOLERANS : PROFİL BOY TOLERANSI :	MATERİYAL MM MDF	TARİH / DATE 01.03.2019

18 mm Profiles

PROFİLSE - SİLAS ORMAN ÜRÜNLERİ

KAĞIT ÜZERİNDEN ÖLÇÜ ALMAYINIZ !!!

Don't measurate on paper.

ÜRÜN KODU : 19*38

(Product Code)

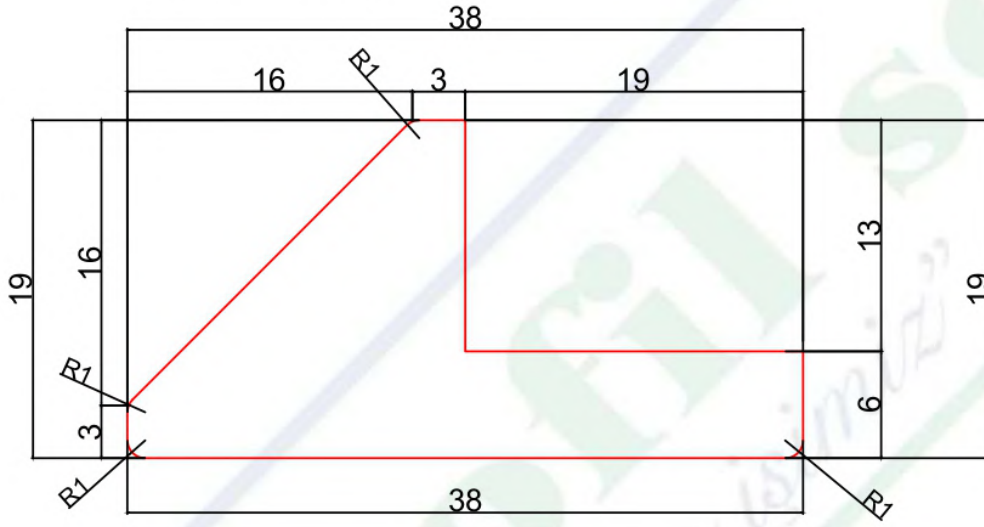

PVC
BİTİŞ (Pvc ending area)
YERİ



BÖLÜM SORUMLUSU NEJDET ALTINTOPRAK	BU ÇİZİM PROFİLSE - SİLAS ORMAN ÜRÜNLERİ'NE AİTTİR. İZINSİZ ÇOĞALTILMAMAK VE KOPYA EDİLMEMEK ŞARTI İLE İZİN VERİLMİŞTİR.	PVC ENİ : MDF MİKTARI : PLAKADAN ÇIKAN :	KSM ÖLÇÜCÜ :	KUTU İÇİ : KUTU İÇİ ADET :
ARGE SORUMLUSU DOĞUKAN DEMİR	THIS DRAWING PROFILE - SİLAS FOREST PRODUCTS WHAT TO DO. UNLOCKED AND COPY NOT ALLOWED WITH THE WRITTEN.	GENEL TOLERANS : PROFL BOY TOLERANSI :	MATERİAL MM MDF	TARİH / DATE 01.03.2019

18 mm Profiles

PROFİLSE - SİLAS ORMAN ÜRÜNLERİ

KAĞIT ÜZERİNDEN ÖLÇÜ ALMAYINIZ !!!

Don't measurate on paper.

ÜRÜN KODU : 18*37
(Product Code)

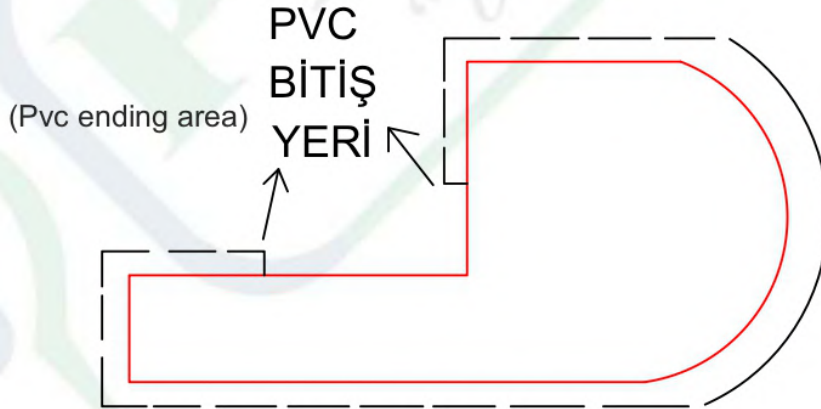
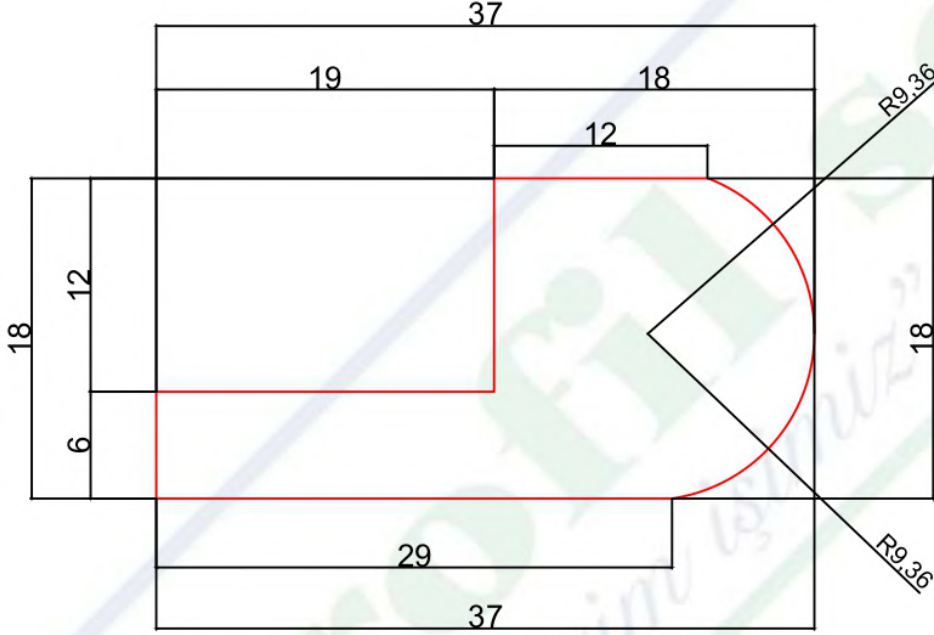

BÖLÜM SORUMLUSU NEJDET ALTINTOPRAK	BU ÇİZİM PROFİLSE - SİLAS ORMAN ÜRÜNLERİ'NE AİTTİR. İZINSİZ ÇOĞALTILMAMAK VE KOPYA EDİLMEKEMEK ŞARTI İLE İZİN VERİLMİŞTİR.	PVC ENİ : MDF MİKTARI : PLAKADAN ÇIKAN :	KSM ÖLÇÜCÜ :	KUTU İÇİ : KUTU İÇİ ADET :
ARGE SORUMLUSU DOĞUKAN DEMİR	THIS DRAWING PROFILE - SİLAS FOREST PRODUCTS WHAT TO DO. UNLOCKED AND COPY NOT ALLOWED WITH THE WRITTEN.	GENEL TOLERANS : PROFİL BOY TOLERANSI :	MATERIAL MM MDF	TARİH / DATE 01.03.2019

18 mm Profiles

PROFİLSE - SİLAS ORMAN ÜRÜNLERİ

KAĞIT ÜZERİNDEN ÖLÇÜ ALMAYINIZ !!!

Don't measurate on paper.

ÜRÜN KODU : 18*37

(Product Code)

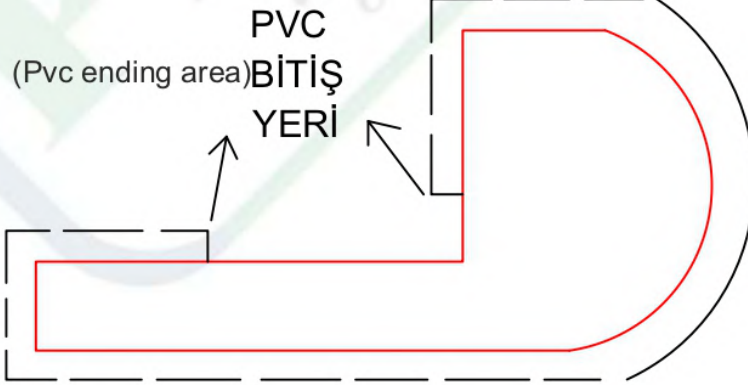
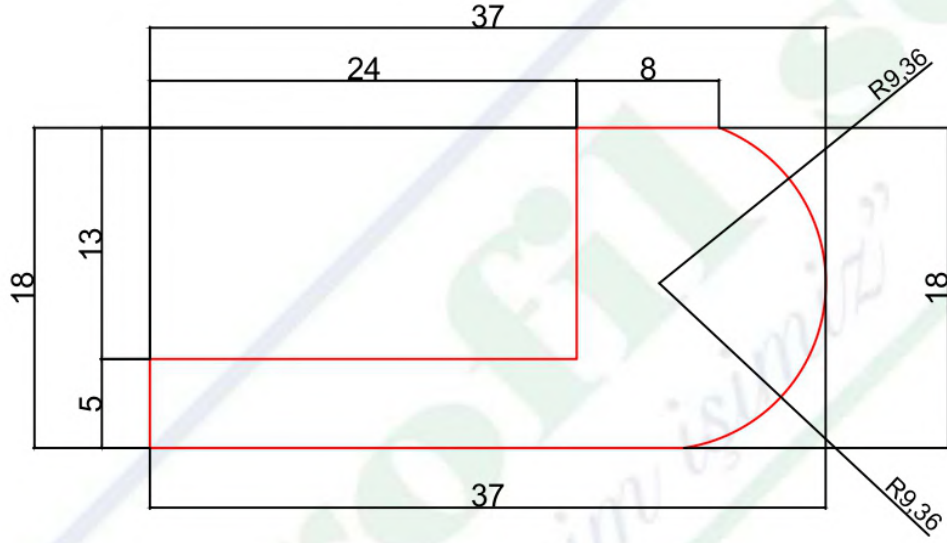

BÖLÜM SORUMLUSU NEJDET ALTINTOPRAK	BU ÇİZİM PROFİLSE - SİLAS ORMAN ÜRÜNLERİ'NE AİTTİR. İZINSİZ ÇOĞALTILMAMAK VE KOPYA EDİLMEMEK ŞARTI İLE İZİN VERİLMİŞTİR.	PVC ENİ : MDF MİKTARI : PLAKADAN ÇIKAN :	KSM ÖLÇÜCÜ :	KUTU İÇİ : KUTU İÇİ ADET :
ARGE SORUMLUSU DOĞUKAN DEMİR	THIS DRAWING PROFILE - SİLAS FOREST PRODUCTS WHAT TO DO. UNLOCKED AND COPY NOT ALLOWED WITH THE WRITTEN.	GENEL TOLERANS : PROFİL BOY TOLERANSI :	MATERİYAL MM MDF	TARİH / DATE 01.03.2019

18 mm Profiles

PROFİLSE - SİLAS ORMAN ÜRÜNLERİ

KAĞIT ÜZERİNDEN ÖLÇÜ ALMAYINIZ !!!

Don't measurate on paper.

ÜRÜN KODU : 18*40

(Product Code)

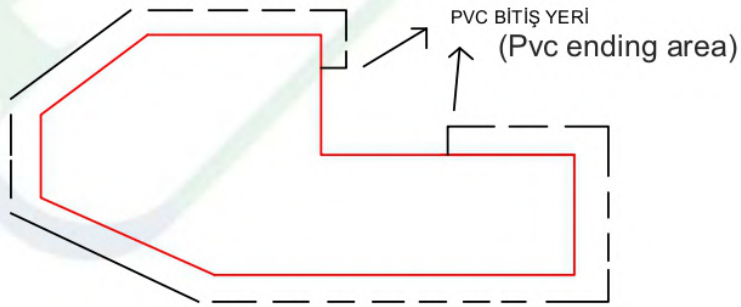
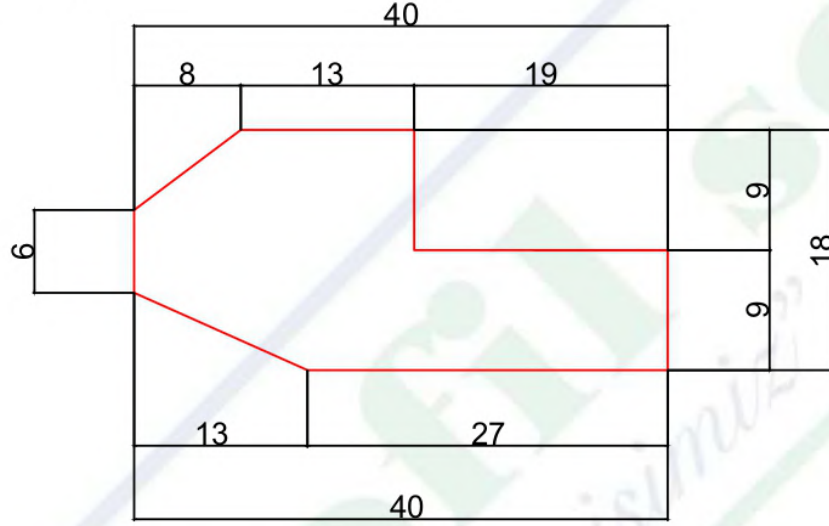

BÖLÜM SORUMLUSU NEJDET ALTINTOPRAK	BU ÇİZİM PROFİLSE - SİLAS ORMAN ÜRÜNLERİ'NE AİTTİR. İZİNSİZ ÇOĞALTILMAMAK VE KOPYA EDİLMEK ŞARTI İLE İZİN VERİLMİŞTİR.	PVC ENİ : MDF MİKTARI : PLAKADAN ÇIKAN :	KSM ÖLÇÜCÜ :	KUTU İÇİ : KUTU İÇİ ADET :
ARGE SORUMLUSU DOĞUKAN DEMİR	THIS DRAWING PROFILE - SİLAS FOREST PRODUCTS WHAT TO DO. UNLOCKED AND COPY NOT ALLOWED WITH THE WRITTEN.	GENEL TOLERANS : PROFİL BOY TOLERANSI :	MATERİYAL MM MDF	TARİH / DATE 05.10.2018

18 mm Profiles

PROFİLSE - SİLAS ORMAN ÜRÜNLERİ

ÜRÜN KODU : 18*60
(Product Code)

Don't measurate on paper.

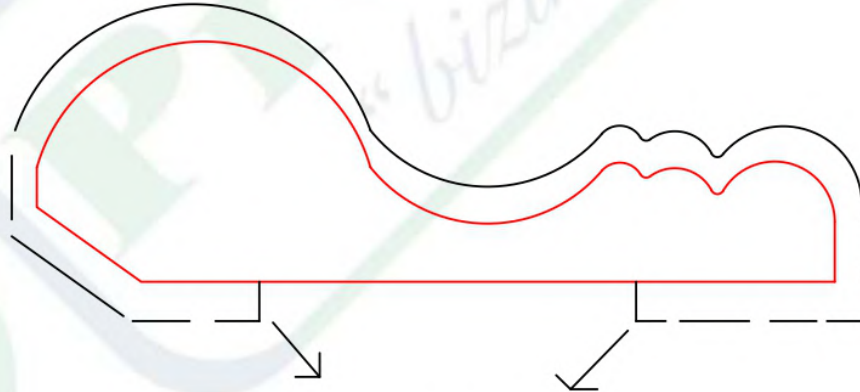
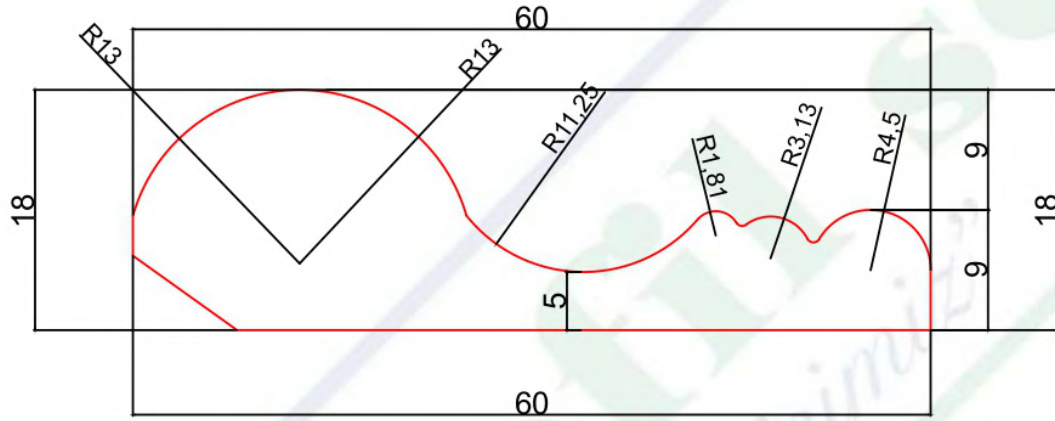

PVC BİTİŞ YERİ

(Pvc ending area)

BÖLÜM SORUMLUSU NEJDET ALTINTOPRAK	BU ÇİZİM PROFİLSE - SİLAS ORMAN ÜRÜNLERİ'NE AİTTİR. İZİNSİZ ÇOĞALTILMAMAK VE KOPYA EDİLMEMEK ŞARTI İLE İZİN VERİLMİŞTİR.	PVC ENİ : MDF MİKTARI : PLAKADAN ÇIKAN :	KSM ÖLÇÜCÜ :	KUTU İÇİ : KUTU İÇİ ADET :
ARGE SORUMLUSU DOĞUKAN DEMİR	THIS DRAWING PROFILE - SİLAS FOREST PRODUCTS WHAT TO DO. UNLOCKED AND COPY NOT ALLOWED WITH THE WRITTEN.	GENEL TOLERANS : PROFİL BOY TOLERANSI :	MATERİYAL : MM MDF	TARİH / DATE 04.10.2018

18 mm Profiles

PROFİLSE - SİLAS ORMAN ÜRÜNLERİ

KAĞIT ÜZERİNDEN ÖLÇÜ ALMAYINIZ !!!

ÜRÜN KODU : 18*80
(Product Code)

Don't measurate on paper.

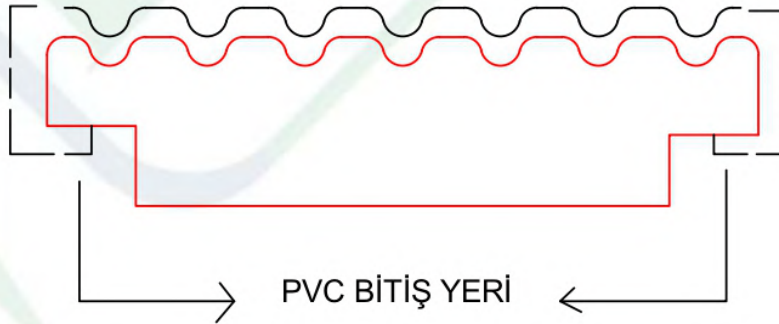
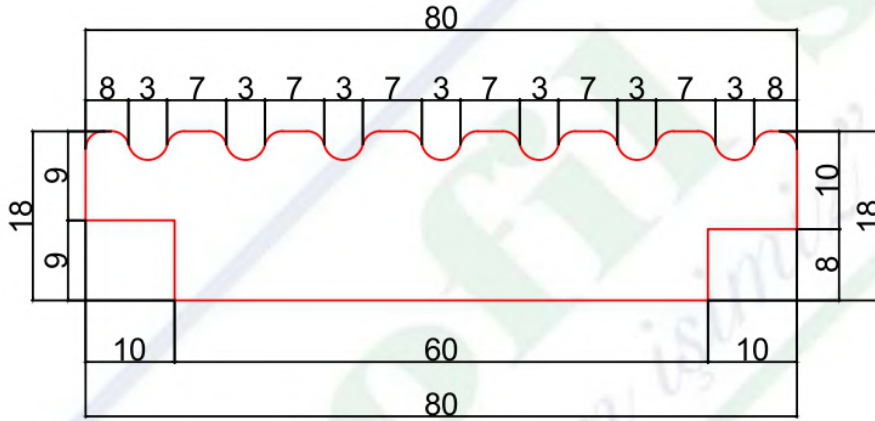

BÖLÜM SORUMLUSU NEJDET ALTINTOPRAK	BU ÇİZİM PROFİLSE - SİLAS ORMAN ÜRÜNLERİ'NE AİTTİR. İZİNSİZ ÇOĞALTILMAMAK VE KOPYA EDİLMEMEK ŞARTI İLE İZİN VERİLMİŞTİR.	PVC ENİ : MDF MİKTARI : PLAKADAN ÇIKAN :	KSM ÖLÇÜCÜ :	KUTU İÇİ : KUTU İÇİ ADET :
ARGE SORUMLUSU DOĞUKAN DEMİR	THIS DRAWING PROFILE - SİLAS FOREST PRODUCTS WHAT TO DO. UNLOCKED AND COPY NOT ALLOWED WITH THE WRITTEN.	GENEL TOLERANS : PROFİL BOY TOLERANSI :	MATERİYAL MM MDF	TARİH / DATE 10.10.2018

18 mm Profiles

PROFİLSE - SİLAS ORMAN ÜRÜNLERİ

KAĞIT ÜZERİNDEN ÖLÇÜ ALMAYINIZ !!!

Don't measurate on paper.

ÜRÜN KODU : 18*25

(Product Code)

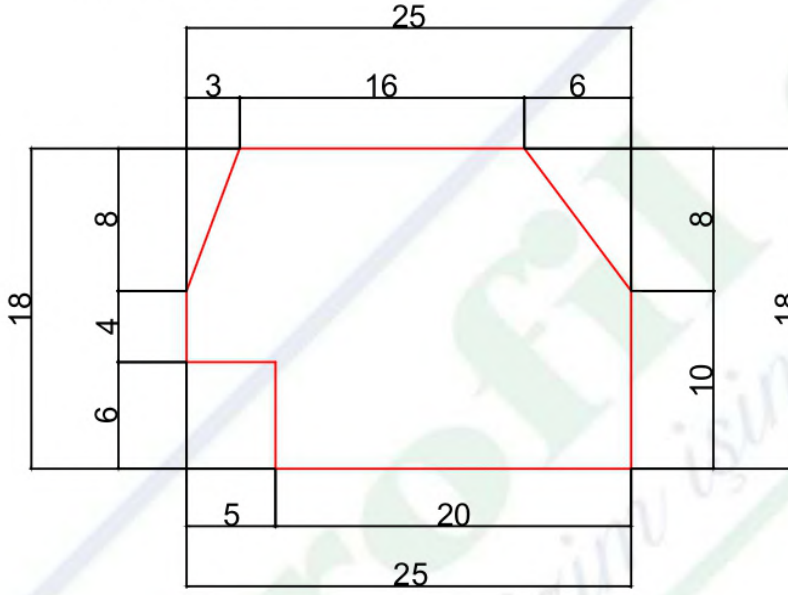

PVC BİTİŞ YERİ
(Pvc ending area)

BÖLÜM SORUMLUSU NEJDET ALTINTOPRAK	BU ÇİZİM PROFİLSE - SİLAS ORMAN ÜRÜNLERİ'NE AİTTİR. İZİNSİZ ÇOĞALTILMAMAK VE KOPYA EDİLMEMEK ŞARTI İLE İZİN VERİLMİŞTİR.	PVC ENİ : MDF MİKTARI : PLAKADAN ÇIKAN :	KSM ÖLÇÜCÜ :	KUTU İÇİ : KUTU İÇİ ADET :
ARGE SORUMLUSU DOĞUKAN DEMİR	THIS DRAWING PROFILE - SİLAS FOREST PRODUCTS WHAT TO DO. UNLOCKED AND COPY NOT ALLOWED WITH THE WRITTEN.	GENEL TOLERANS : PROFİL BOY TOLERANSI :	MATERİYAL MM MDF	TARİH / DATE 10.10.2018

18 mm Profiles

PROFİLSE - SİLAS ORMAN ÜRÜNLERİ

KAĞIT ÜZERİNDEN ÖLÇÜ ALMAYINIZ !!!

ÜRÜN KODU : 18*60-02

Don't measurate on paper.

(Product Code)

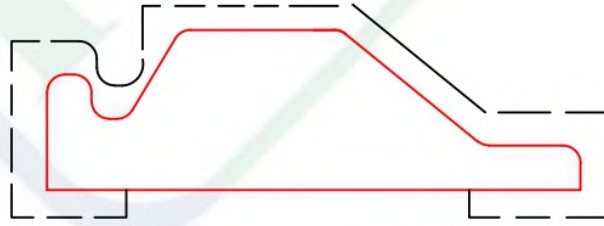
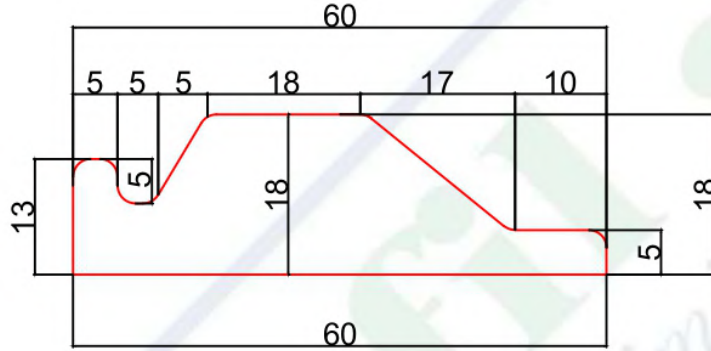

PVC BİTİŞ YERİ
(Pvc ending area)

BÖLÜM SORUMLUSU NEJDET ALTINTOPRAK	BU ÇİZİM PROFİLSE - SİLAS ORMAN ÜRÜNLERİ'NE AİTTİR. İZİNSİZ ÇOĞALTILMAMAK VE KOPYA EDİLMEMEK ŞARTI İLE İZİN VERİLMİŞTİR.	PVC ENİ : MDF MİKTARI : PLAKADAN ÇIKAN :	KSM ÖLÇÜCÜ :	KUTU İÇİ : KUTU İÇİ ADET :
ARGE SORUMLUSU DOĞUKAN DEMİR	THIS DRAWING PROFILE - SILAS FOREST PRODUCTS WHAT TO DO. UNLOCKED AND COPY NOT ALLOWED WITH THE WRITTEN.	GENEL TOLERANS : PROFİL BOY TOLERANSI :	MATERİYAL MM MDF	TARİH / DATE 10.10.2018

18 mm Profiles

PROFİLSE - SİLAS ORMAN ÜRÜNLERİ

KAĞIT ÜZERİNDEN ÖLÇÜ ALMAYINIZ !!!

Don't measurate on paper.

ÜRÜN KODU : 18*43

(Product Code)

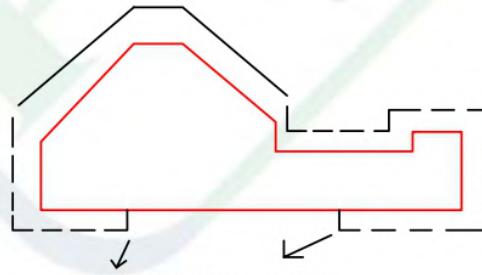
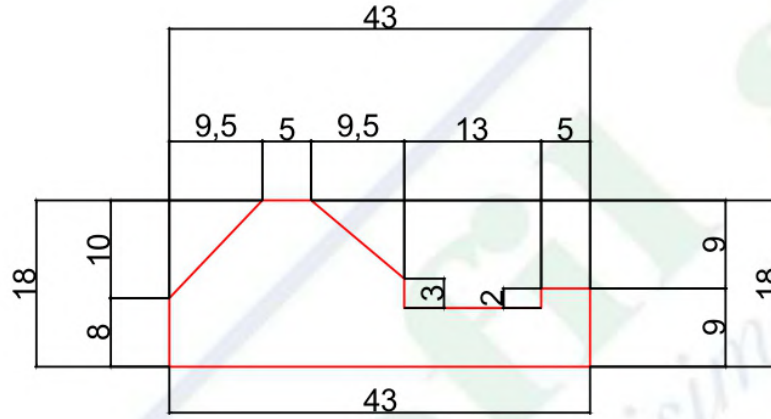

PVC BİTİŞ YERİ

(Pvc ending area)

BÖLÜM SORUMLUSU NEJDET ALTINTOPRAK	BU ÇİZİM PROFİLSE - SİLAS ORMAN ÜRÜNLERİ'NE AİTTİR. İZINSİZ ÇOĞALTILMAMAK VE KOPYA EDİLMEKEMEK ŞARTI İLE İZİN VERİLMİŞTİR.	PVC ENİ : MDF MİKTARI : PLAKADAN ÇIKAN :	KSM ÖLÇÜCÜ :	KUTU İÇİ : KUTU İÇİ ADET :
ARGE SORUMLUSU DOĞUKAN DEMİR	THIS DRAWING PROFILE - SİLAS FOREST PRODUCTS WHAT TO DO. UNLOCKED AND COPY NOT ALLOWED WITH THE WRITTEN.	GENEL TOLERANS : PROFİL BOY TOLERANSI :	MATERIAL MM MDF	TARİH / DATE 22.11.2018

18 mm Profiles

PROFİLSE - SİLAS ORMAN ÜRÜNLERİ

KAĞIT ÜZERİNDEN ÖLÇÜ ALMAYINIZ !!!
Don't measurate on paper.

ÜRÜN KODU : 18*45
(Product Code)

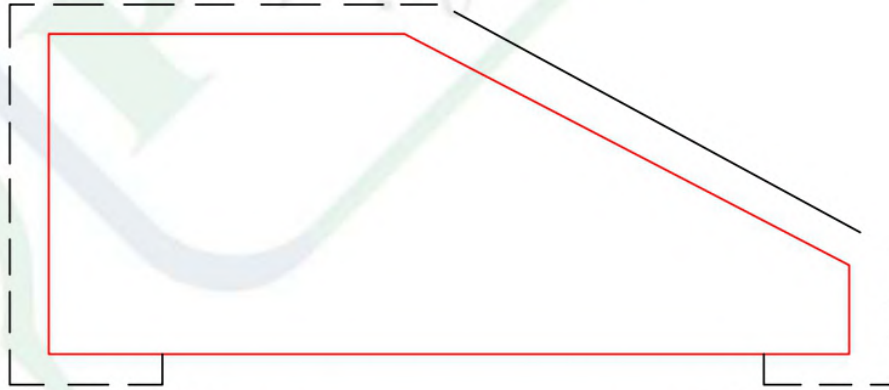

PVC BİTİŞ YERİ
(Pvc ending area)

BÖLÜM SORUMLUSU NEJDET ALTINTOPRAK	BU ÇİZİM PROFİLSE - SİLAS ORMAN ÜRÜNLERİ'NE AİTTİR. İZINSİZ ÇOĞALTILMAMAK VE KOPYA EDİLMEMEK ŞARTI İLE İZİN VERİLMİŞTİR.	PVC ENİ : MDF MİKTARI : PLAKADAN ÇIKAN :	KSM ÖLÇÜCÜ :	KUTU İÇİ : KUTU İÇİ ADET :
ARGE SORUMLUSU DOĞUKAN DEMİR	THIS DRAWING PROFILE - SİLAS FOREST PRODUCTS WHAT TO DO. UNLOCKED AND COPY NOT ALLOWED WITH THE WRITTEN.	GENEL TOLERANS : PROFL BOY TOLERANSI :	MATERİYAL MM MDF	TARİH / DATE 12.11.2018

18 mm Profiles

PROFİLSE - SİLAS ORMAN ÜRÜNLERİ

KAĞIT ÜZERİNDEN ÖLÇÜ ALMAYINIZ !!!

Don't measurate on paper.

ÜRÜN KODU : 18*40
(Product Code)

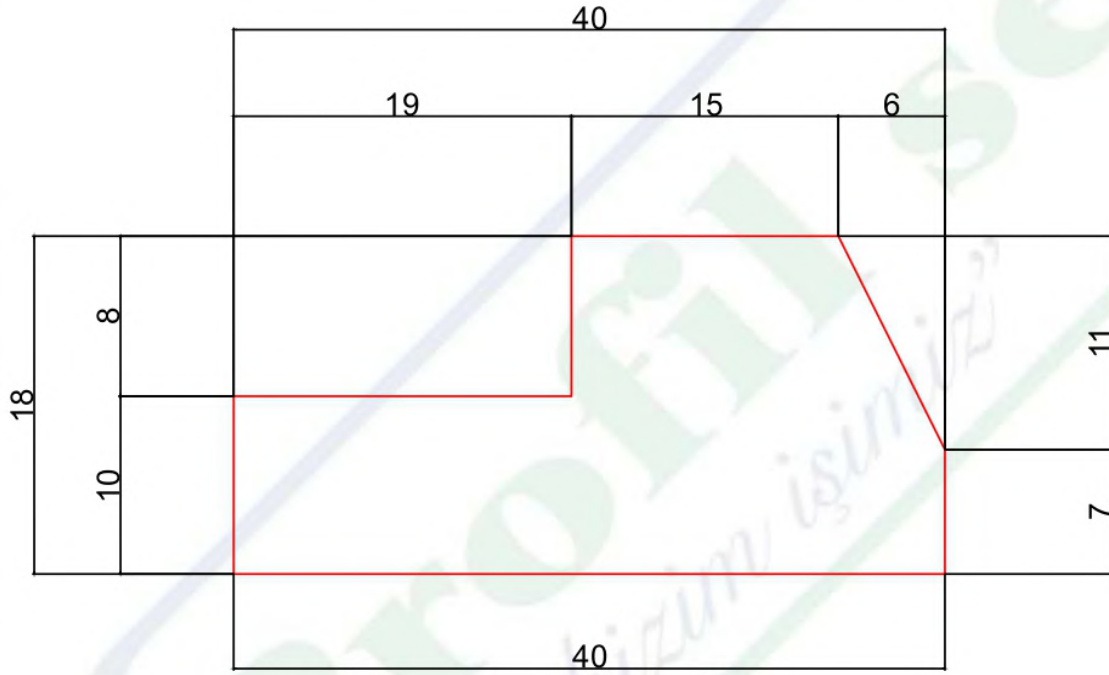

(Pvc ending area)

PVC BİTİŞ YERİ

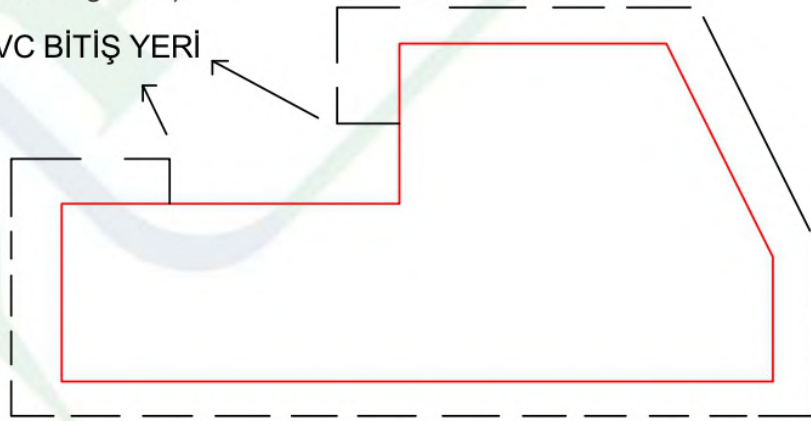

BÖLÜM SORUMLUSU NEJDET ALTINTOPRAK	BU ÇİZİM PROFİLSE - SİLAS ORMAN ÜRÜNLERİ'NE AİTTİR. İZINSİZ ÇOĞALTILMAMAK VE KOPYA EDİLMEMEK ŞARTI İLE İZİN VERİLMİŞTİR.	PVC ENİ : MDF MİKTARI : PLAKADAN ÇIKAN :	KSM ÖLÇÜCÜ :	KUTU İÇİ : KUTU İÇİ ADET :
ARGE SORUMLUSU DOĞUKAN DEMİR	THIS DRAWING PROFILE - SİLAS FOREST PRODUCTS WHAT TO DO. UNLOCKED AND COPY NOT ALLOWED WITH THE WRITTEN.	GENEL TOLERANS : PROFİL BOY TOLERANSI :	MATERİYAL MM MDF	TARİH / DATE 12.11.2018

18 mm Profiles

PROFİLSE - SİLAS ORMAN ÜRÜNLERİ

KAĞIT ÜZERİNDEN ÖLÇÜ ALMAYINIZ !!!

Don't measurate on paper.

ÜRÜN KODU : 18*90

(Product Code)

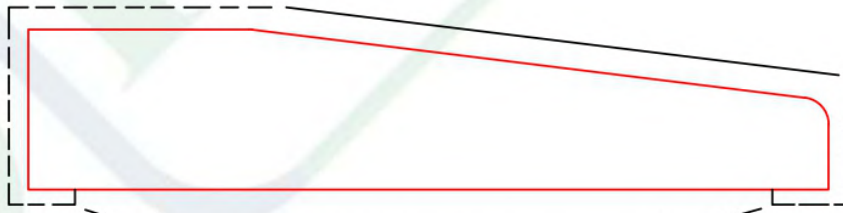
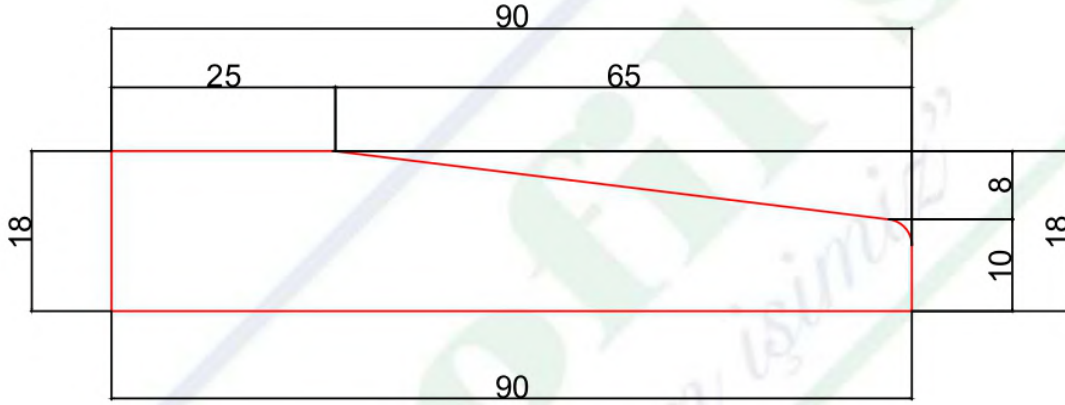

PVC BİTİŞ YERİ
(Pvc ending area)

BÖLÜM SORUMLUSU NEJDET ALTINTOPRAK	BU ÇİZİM PROFİLSE - SİLAS ORMAN ÜRÜNLERİ'NE AİTTİR. İZINSİZ ÇOĞALTILMAMAK VE KOPYA EDİLMEMEK ŞARTI İLE İZİN VERİLMİŞTİR.	PVC ENİ : MDF MİKTARI : PLAKADAN ÇIKAN :	KSM ÖLÇÜCÜ :	KUTU İÇİ : KUTU İÇİ ADET :
ARGE SORUMLUSU DOĞUKAN DEMİR	THIS DRAWING PROFILE - SİLAS FOREST PRODUCTS WHAT TO DO. UNLOCKED AND COPY NOT ALLOWED WITH THE WRITTEN.	GENEL TOLERANS : PROFİL BOY TOLERANSI :	MATERİYAL MM MDF	TARİH / DATE 04.12.2018

18 mm Profiles

PROFİLSE - SİLAS ORMAN ÜRÜNLERİ

KAĞIT ÜZERİNDEN ÖLÇÜ ALMAYINIZ !!!
Don't measure on paper.

ÜRÜN KODU : 18*60
(Product Code)

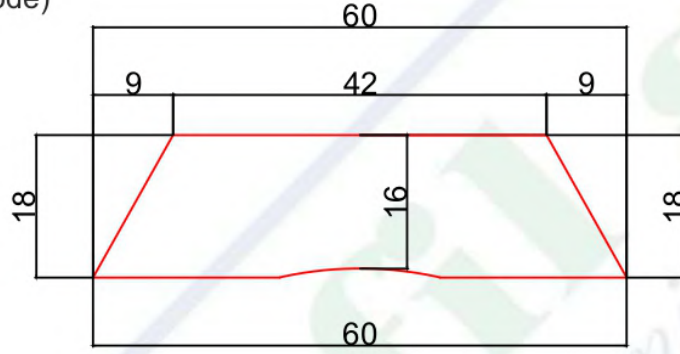

BÖLÜM SORUMLUSU NEJDET ALTINTOPRAK	BU ÇİZİM PROFİLSE - SİLAS ORMAN ÜRÜNLERİ'NE AİTTİR. İZINSİZ ÇOĞALTILMAMAK VE KOPYA EDİLMEMEK ŞARTI İLE İZİN VERİLMİŞTİR.	PVC ENİ : MDF MİKTARI : PLAKADAN ÇIKAN :	KSM ÖLÇÜCÜ :	KUTU İÇİ : KUTU İÇİ ADET :
ARGE SORUMLUSU DOĞUKAN DEMİR	THIS DRAWING PROFILE - SİLAS FOREST PRODUCTS WHAT TO DO. UNLOCKED AND COPY NOT ALLOWED WITH THE WRITTEN.	GENEL TOLERANS : PROFİL BOY TOLERANSI :	MATERİYAL MM MDF	TARİH / DATE 04.10.2018

18 mm Profiles

PROFİLSE - SİLAS ORMAN ÜRÜNLERİ

ÜRÜN KODU : 18*35
(Product Code)

KAĞIT ÜZERİNDEN ÖLÇÜ ALMAYINIZ !!!
Don't measurate on paper.

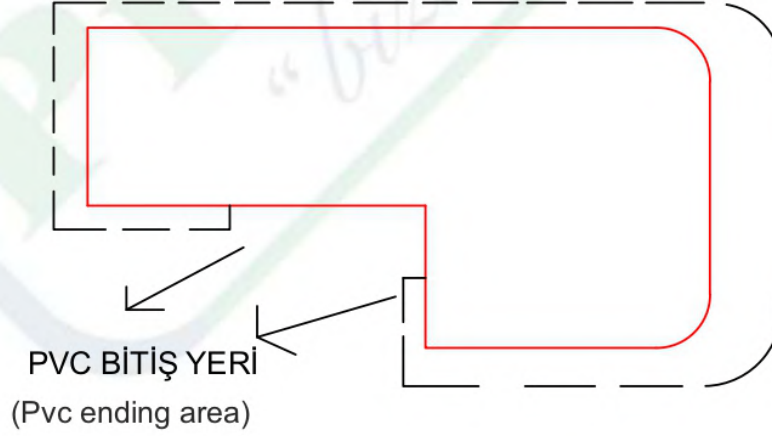
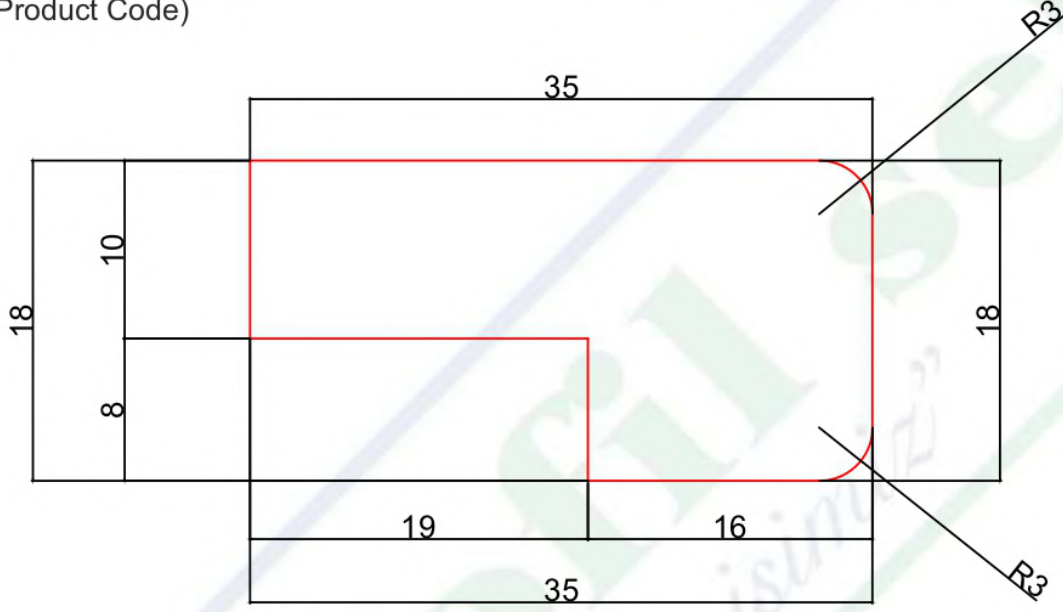

BÖLÜM SORUMLUSU NEJDET ALTINTOPRAK	BU ÇİZİM PROFİLSE - SİLAS ORMAN ÜRÜNLERİ'NE AİTTİR. İZİNSİZ ÇOĞALTILMAMAK VE KOPYA EDİLMEMEK ŞARTI İLE İZİN VERİLMİŞTİR.	PVC ENİ : MDF MİKTARI : PLAKADAN ÇIKAN :	KSM ÖLÇÜCÜ :	KUTU İÇİ : KUTU İÇİ ADET :
ARGE SORUMLUSU DOĞUKAN DEMİR	THIS DRAWING PROFILE - SİLAS FOREST PRODUCTS WHAT TO DO. UNLOCKED AND COPY NOT ALLOWED WITH THE WRITTEN.	GENEL TOLERANS : PROFİL BOY TOLERANSI :	MATERİYAL MM MDF	TARİH / DATE 04.10.2018

18 mm Profiles

PROFİLSE - SİLAS ORMAN ÜRÜNLERİ

ÜRÜN KODU : 18*37
(Product Code)

KAĞIT ÜZERİNDEN ÖLÇÜ ALMAYINIZ !!!
Don't measure on paper.

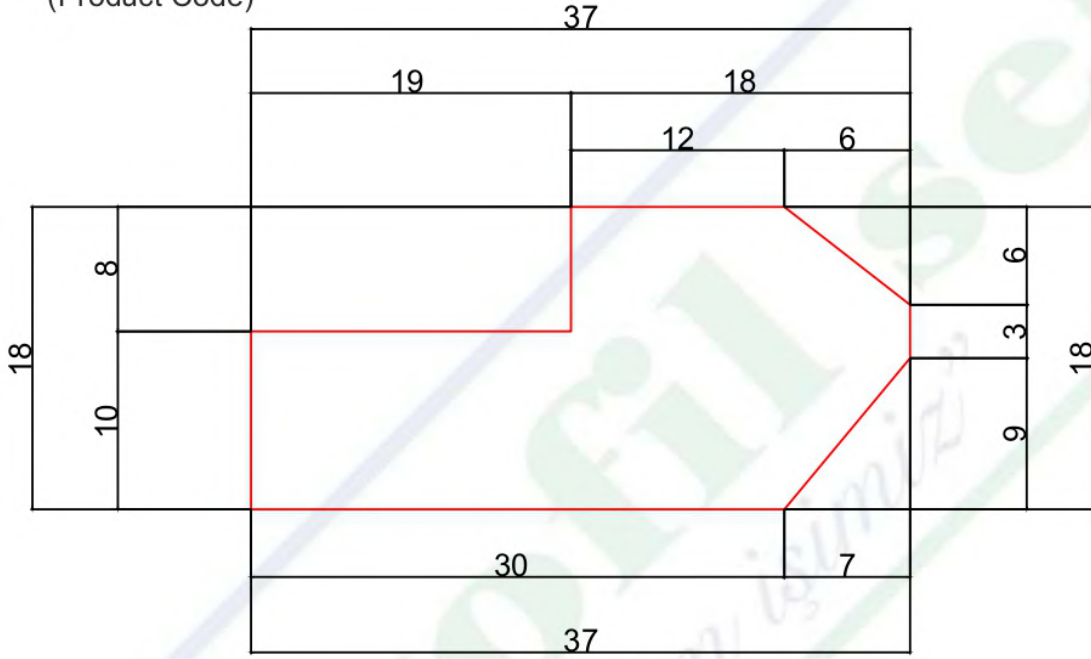

(Pvc ending area)

PVC BİTİŞ YERİ

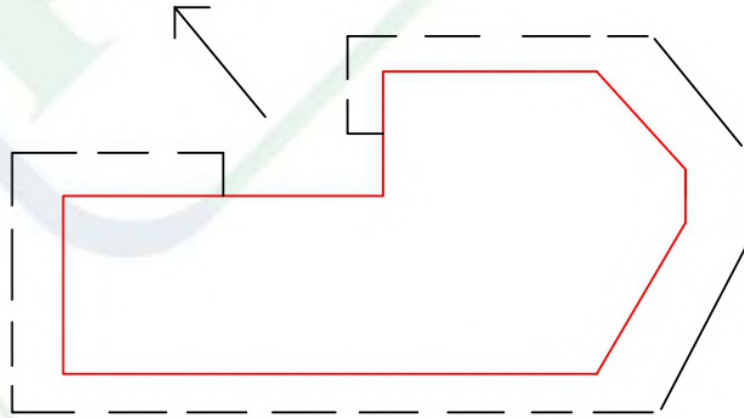

BÖLÜM SORUMLUSU NEJDET ALTINTOPRAK	BU ÇİZİM PROFİLSE - SİLAS ORMAN ÜRÜNLERİ'NE AİTTİR. İZINSİZ ÇOĞALTILMAMAK VE KOPYA EDİLMEK ŞARTI İLE İZİN VERİLMİŞTİR.	PVC ENİ : MDF MİKTARI : PLAKADAN ÇIKAN :	KSM ÖLÇÜCÜ :	KUTU İÇİ : KUTU İÇİ ADET :
ARGE SORUMLUSU DOĞUKAN DEMİR	THIS DRAWING PROFILE - SILAS FOREST PRODUCTS WHAT TO DO. UNLOCKED AND COPY NOT ALLOWED WITH THE WRITTEN.	GENEL TOLERANS : PROFİL BOY TOLERANSI :	MATERİYAL MM MDF	TARİH / DATE 04.10.2018

22 mm Profiles

PROFİLSE - SİLAS ORMAN ÜRÜNLERİ

KAĞIT ÜZERİNDEN ÖLÇÜ ALMAYINIZ !!!
Don't measurate on paper.

ÜRÜN KODU : 22*60

(Product Code)

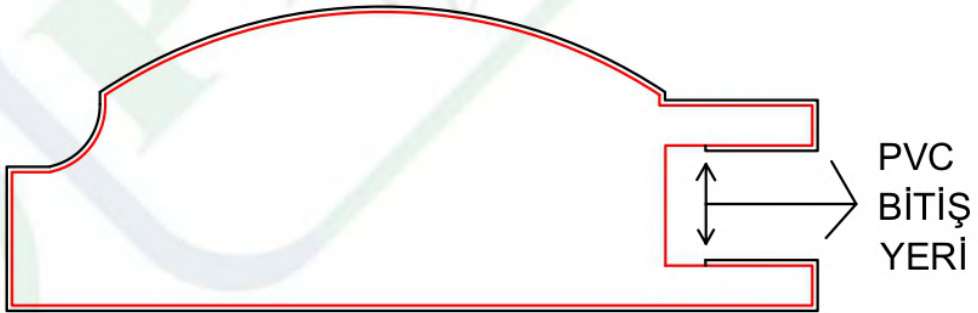
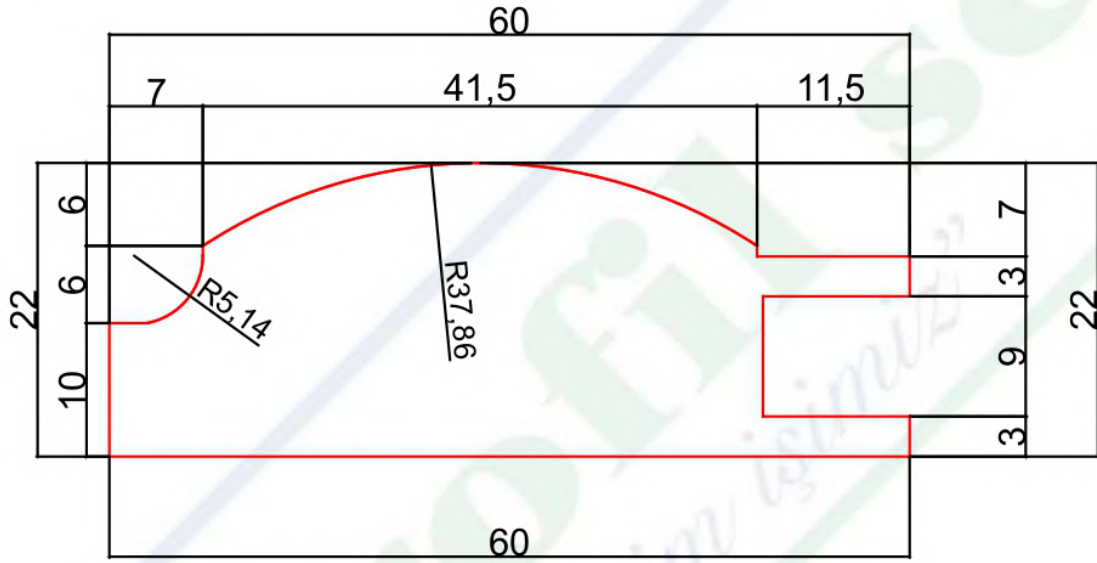

BÖLÜM SORUMLUSU NEJDET ALTINTOPRAK	BU ÇİZİM PROFİLSE - SİLAS ORMAN ÜRÜNLERİ'NE AİTTİR. İZİNSİZ ÇOĞALTILMAMAK VE KOPYA EDİLMEK ŞARTI İLE İZİN VERİLMİŞTİR.	PVC ENİ : MDF MİKTARI : PLAKADAN ÇIKAN :	KSM ÖLÇÜCÜ :	KUTU İÇİ : KUTU İÇİ ADET :
ARGE SORUMLUSU DOĞUKAN DEMİR	THIS DRAWING PROFILE - SİLAS FOREST PRODUCTS WHAT TO DO. UNLOCKED AND COPY NOT ALLOWED WITH THE WRITTEN.	GENEL TOLERANS : PROFİL BOY TOLERANSI :	MATERİYAL MM MDF	TARİH / DATE 17.01.2019

22 mm Profiles

PROFİLSE - SİLAS ORMAN ÜRÜNLERİ

KAĞIT ÜZERİNDEN ÖLÇÜ ALMAYINIZ !!!

Don't measurate on paper.

ÜRÜN KODU : 22*37-14
(Product Code)

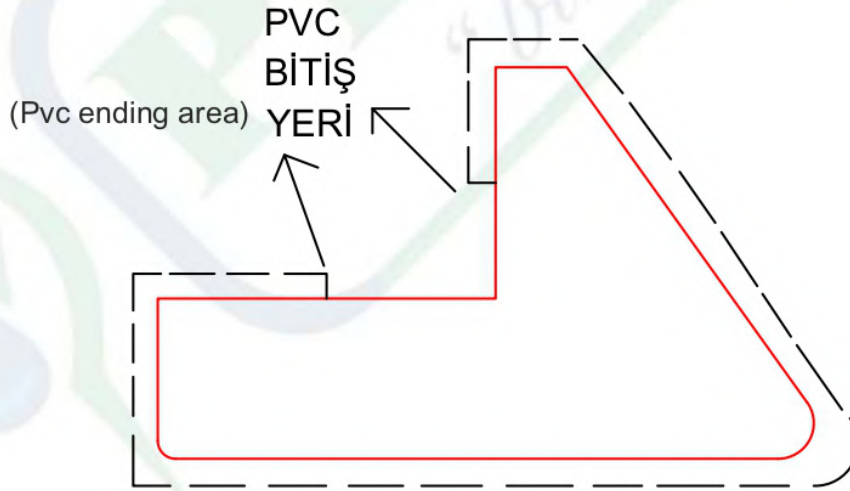
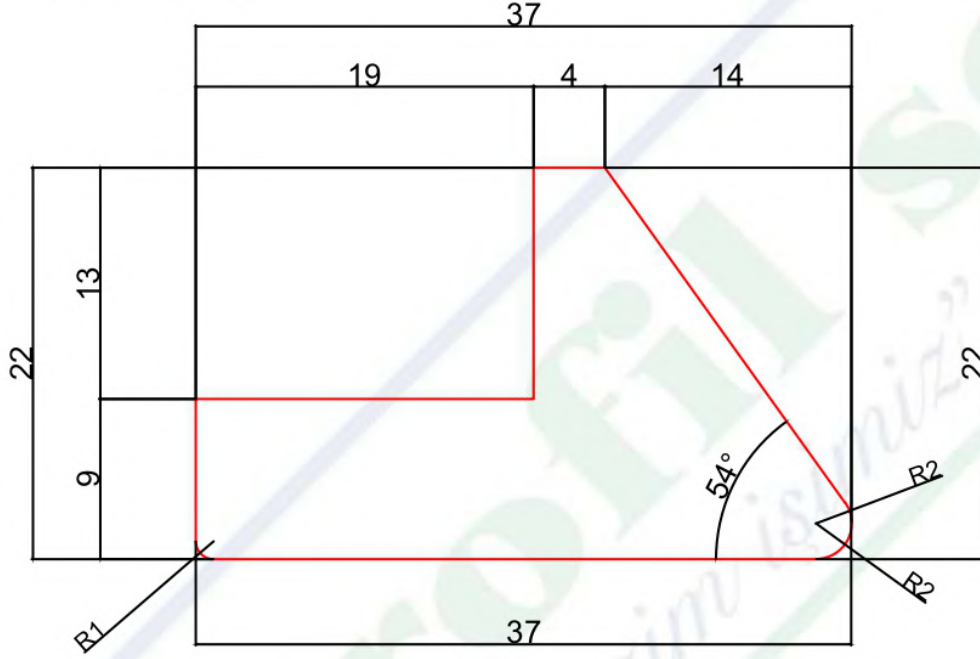

BÖLÜM SORUMLUSU NEJDET ALTINTOPRAK	BU ÇİZİM PROFİLSE - SİLAS ORMAN ÜRÜNLERİ'NE AİTTİR. İZINSİZ ÇOĞALTILMAMAK VE KOPYA EDİLMEKEMEK ŞARTI İLE İZİN VERİLMİŞTİR.	PVC ENİ : MDF MİKTARI : PLAKADAN ÇIKAN :	KSM ÖLÇÜCÜ :	KUTU İÇİ : KUTU İÇİ ADET :
ARGE SORUMLUSU DOĞUKAN DEMİR	THIS DRAWING PROFILE - SİLAS FOREST PRODUCTS WHAT TO DO. UNLOCKED AND COPY NOT ALLOWED WITH THE WRITTEN.	GENEL TOLERANS : PROFİL BOY TOLERANSI :	MATERİYAL : MM MDF	TARİH / DATE 18.01.2019

22 mm Profiles

PROFİLSE - SİLAS ORMAN ÜRÜNLERİ

KAĞIT ÜZERİNDEN ÖLÇÜ ALMAYINIZ !!!
Don't measure on paper.

ÜRÜN KODU : 22*50
(Product Code)

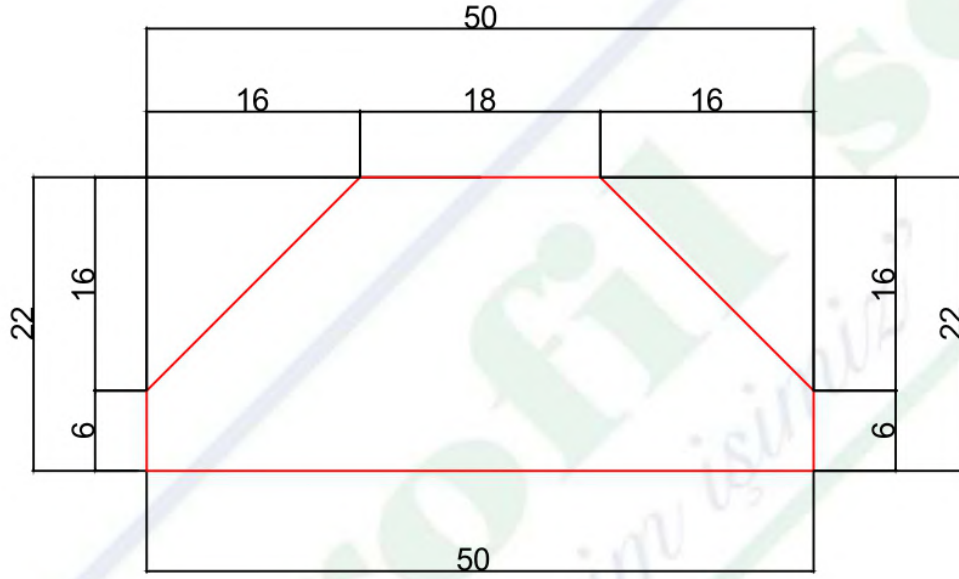

PVC BİTİŞ YERİ
(Pvc ending area)

BÖLÜM SORUMLUSU NEJDET ALTINTOPRAK	BU ÇİZİM PROFİLSE - SİLAS ORMAN ÜRÜNLERİ'NE AİTTİR. İZINSİZ ÇOĞALTILMAMAK VE KOPYA EDİLMEMEK ŞARTI İLE İZİN VERİLMİŞTİR.	PVC ENİ : MDF MİKTARI : PLAKADAN ÇIKAN :	KSM ÖLÇÜCÜ :	KUTU İÇİ : KUTU İÇİ ADET :
ARGE SORUMLUSU DOĞUKAN DEMİR	THIS DRAWING PROFILE - SILAS FOREST PRODUCTS WHAT TO DO. UNLOCKED AND COPY NOT ALLOWED WITH THE WRITTEN.	GENEL TOLERANS : PROFİL BOY TOLERANSI :	MATERIAL MM MDF	TARİH / DATE 04.10.2018

22 mm Profiles

PROFİLSE - SİLAS ORMAN ÜRÜNLERİ

ÜRÜN KODU : 22*65
(Product Code)

Don't measurate on paper.

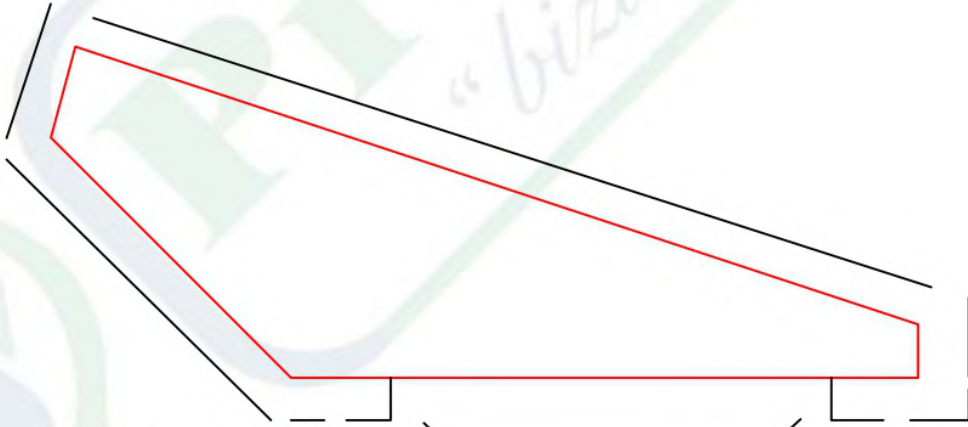
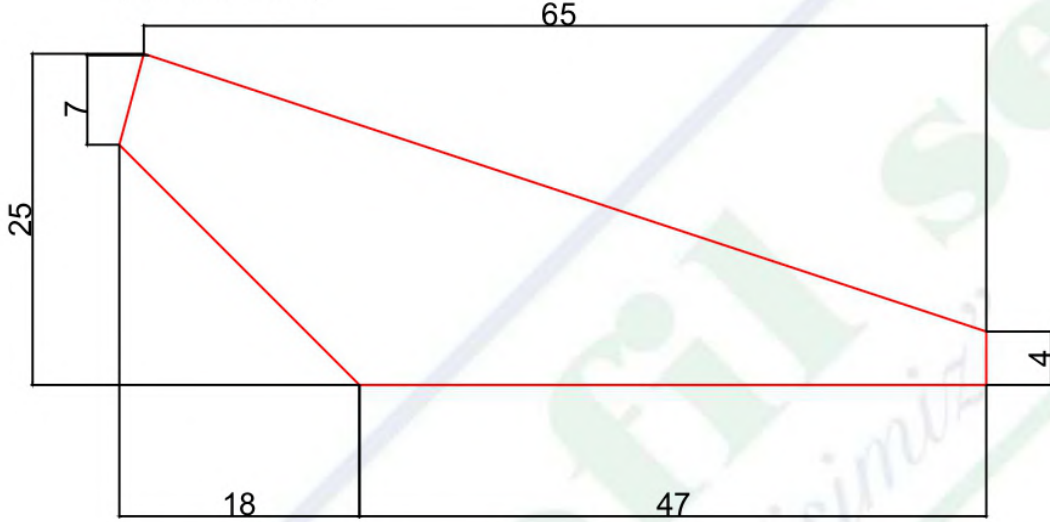

PVC BİTİŞ YERİ
(Pvc ending area)

BÖLÜM SORUMLUSU NEJDET ALTINTOPRAK	BU ÇİZİM PROFİLSE - SİLAS ORMAN ÜRÜNLERİ'NE AİTTİR. İZİNSİZ ÇOĞALTILMAMAK VE KOPYA EDİLMEMEK ŞARTI İLE İZİN VERİLMİŞTİR.	PVC ENİ : MDF MİKTARI : PLAKADAN ÇIKAN :	KSM ÖLÇÜCÜ :	KUTU İÇİ : KUTU İÇİ ADET :
ARGE SORUMLUSU DOĞUKAN DEMİR	THIS DRAWING PROFILE - SİLAS FOREST PRODUCTS WHAT TO DO. UNLOCKED AND COPY NOT ALLOWED WITH THE WRITTEN.	GENEL TOLERANS : PROFİL BOY TOLERANSI :	MATERİYAL MM MDF	TARİH / DATE 04.10.2018

22 mm Profiles

PROFİLSE - SİLAS ORMAN ÜRÜNLERİ

KAĞIT ÜZERİNDEN ÖLÇÜ ALMAYINIZ !!!
Don't measure on paper.

ÜRÜN KODU : 22*80
(Product Code)

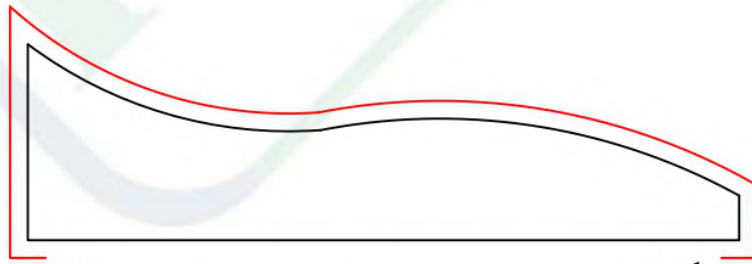
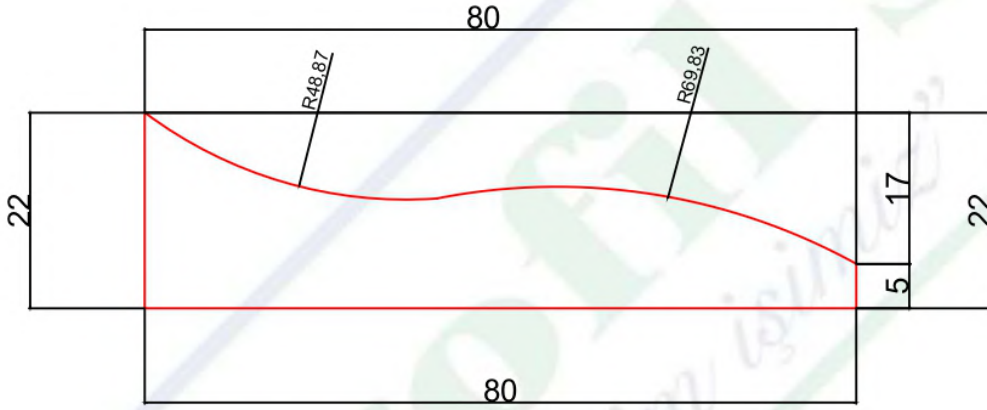

PVC BİTİŞ YERİ
(Pvc ending area)

BÖLÜM SORUMLUSU NEJDET ALTINTOPRAK	BU ÇİZİM PROFİLSE - SİLAS ORMAN ÜRÜNLERİ'NE AİTTİR. İZINSİZ ÇOĞALTILMAMAK VE KOPYA EDİLMEMEK ŞARTI İLE İZİN VERİLMİŞTİR.	PVC ENİ : MDF MİKTARI : PLAKADAN ÇIKAN :	KSM ÖLÇÜCÜ :	KUTU İÇİ : KUTU İÇİ ADET :
ARGE SORUMLUSU DOĞUKAN DEMİR	THIS DRAWING PROFILE - SİLAS FOREST PRODUCTS WHAT TO DO. UNLOCKED AND COPY NOT ALLOWED WITH THE WRITTEN.	GENEL TOLERANS : PROFİL BOY TOLERANSI :	MATERİYAL MM MDF	TARİH / DATE 19.02.2019

22 mm Profiles

PROFİLSE - SİLAS ORMAN ÜRÜNLERİ

KAĞIT ÜZERİNDEN ÖLÇÜ ALMAYINIZ !!!
Don't measurate on paper.

ÜRÜN KODU : 22*20
(Product Code)

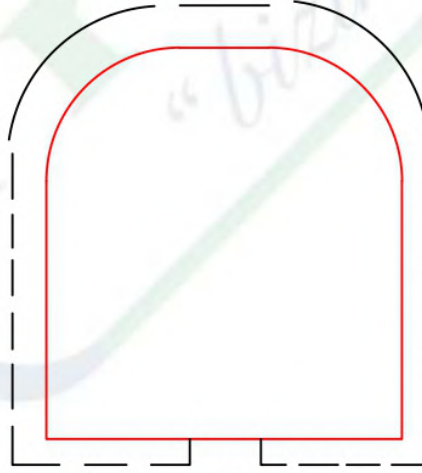
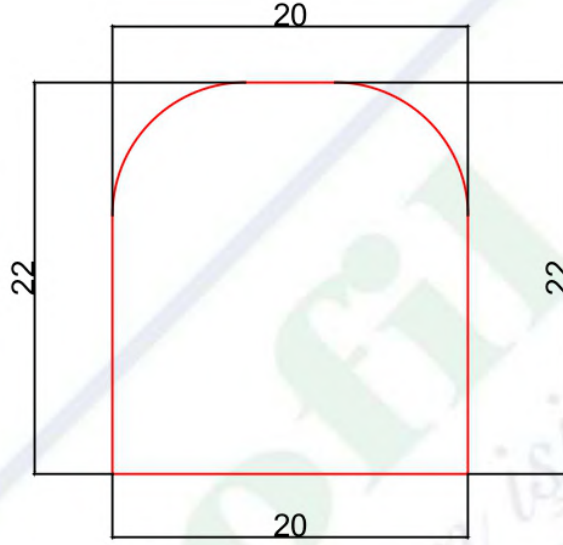

PVC BİTİŞ YERİ
(Pvc ending area)

BÖLÜM SORUMLUSU NEJDET ALTINTOPRAK	BU ÇİZİM PROFİLSE - SİLAS ORMAN ÜRÜNLERİ'NE AİTTİR. İZINSİZ ÇOĞALTILMAMAK VE KOPYA EDİLMEKEMEK ŞARTI İLE İZİN VERİLMİŞTİR.	PVC ENİ : MDF MİKTARI : PLAKADAN ÇIKAN :	KSM ÖLÇÜCÜ :	KUTU İÇİ : KUTU İÇİ ADET :
ARGE SORUMLUSU DOĞUKAN DEMİR	THIS DRAWING PROFILE - SİLAS FOREST PRODUCTS WHAT TO DO. UNLOCKED AND COPY NOT ALLOWED WITH THE WRITTEN.	GENEL TOLERANS : PROFİL BOY TOLERANSI :	MATERİYAL MM MDF	TARİH / DATE 04.10.2018

22 mm Profiles

PROFİLSE - SİLAS ORMAN ÜRÜNLERİ

ÜRÜN KODU : 22*36
(Product Code)

KAĞIT ÜZERİNDEN ÖLÇÜ ALMAYINIZ !!!
Don't measure on paper.

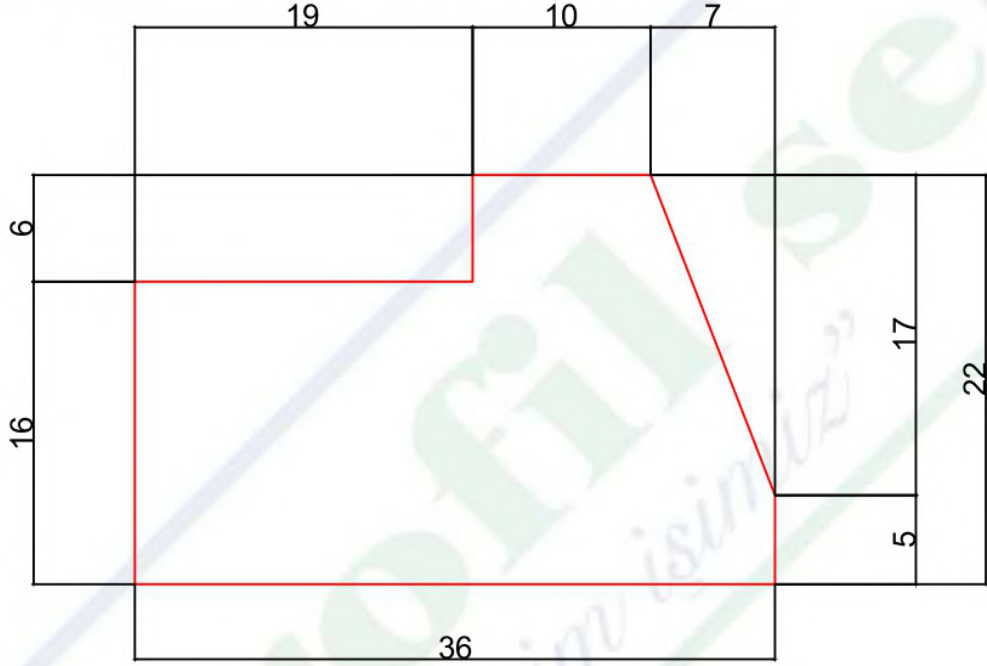

PVC BİTİŞ YERİ
(Pvc ending area)

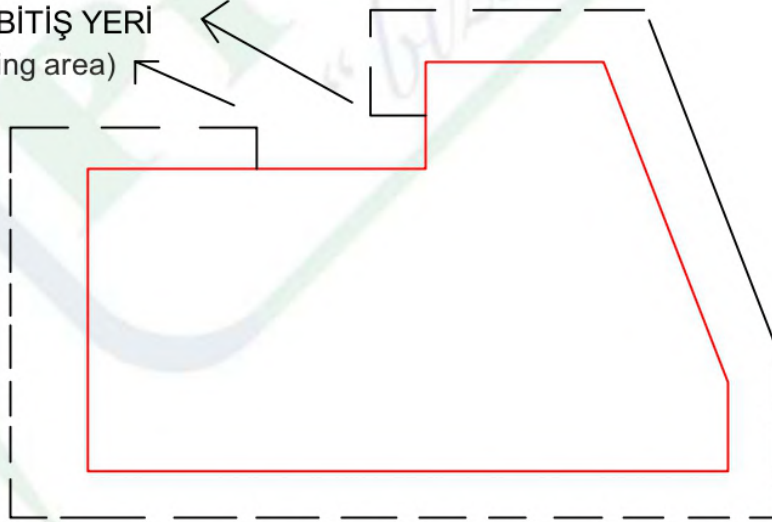

BÖLÜM SORUMLUSU NEJDET ALTINTOPRAK	BU ÇİZİM PROFİLSE - SİLAS ORMAN ÜRÜNLERİ'NE AİTTİR. İZINSİZ ÇOĞALTILMAMAK VE KOPYA EDİLMEMEK ŞARTI İLE İZİN VERİLMİŞTİR.	PVC ENİ : MDF MİKTARI : PLAKADAN ÇIKAN :	KSM ÖLÇÜCÜ :	KUTU İÇİ : KUTU İÇİ ADET :
ARGE SORUMLUSU DOĞUKAN DEMİR	THIS DRAWING PROFILE - SİLAS FOREST PRODUCTS WHAT TO DO. UNLOCKED AND COPY NOT ALLOWED WITH THE WRITTEN.	GENEL TOLERANS : PROFİL BOY TOLERANSI :	MATERİYAL MM MDF	TARİH / DATE 12.11.2018

22 mm Profiles

PROFİLSE - SİLAS ORMAN ÜRÜNLERİ

KAĞIT ÜZERİNDEN ÖLÇÜ ALMAYINIZ !!!
Don't measure on paper.

ÜRÜN KODU : 22*30-01

(Product Code)

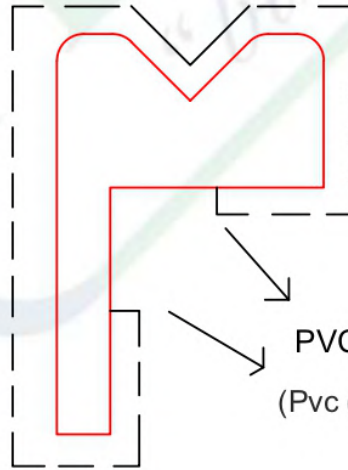
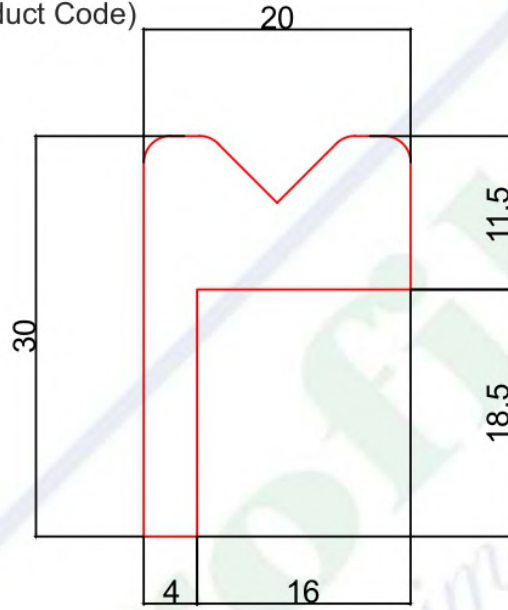

PVC BİTİŞ YERİ
(Pvc ending area)

BÖLÜM SORUMLUSU NEJDET ALTINTOPRAK	BU ÇİZİM PROFİLSE - SİLAS ORMAN ÜRÜNLERİ'NE AİTTİR. İZİNSİZ ÇOĞALTILMAMAK VE KOPYA EDİLMEMEK ŞARTI İLE İZİN VERİLMİŞTİR.	PVC ENİ : MDF MİKTARI : PLAKADAN ÇIKAN :	KSM ÖLÇÜCÜ :	KUTU İÇİ : KUTU İÇİ ADET :
ARGE SORUMLUSU DOĞUKAN DEMİR	THIS DRAWING PROFILE - SİLAS FOREST PRODUCTS WHAT TO DO. UNLOCKED AND COPY NOT ALLOWED WITH THE WRITTEN.	GENEL TOLERANS : PROFİL BOY TOLERANSI :	MATERİYAL MM MDF	TARİH / DATE 19.11.2018

22 mm Profiles

PROFİLSE - SİLAS ORMAN ÜRÜNLERİ

KAĞIT ÜZERİNDEN ÖLÇÜ ALMAYINIZ !!!

ÜRÜN KODU : 22*38
(Product Code)

Don't measurate on paper.

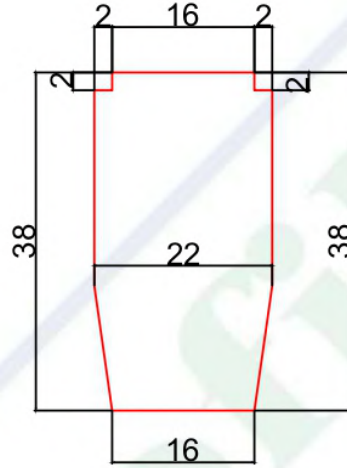

(Pvc ending area)

PVC BİTİŞ YERİ

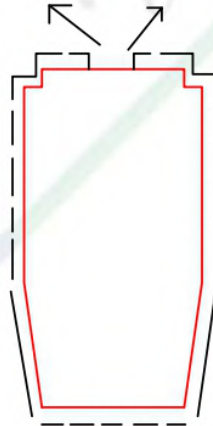

BÖLÜM SORUMLUSU NEJDET ALTINTOPRAK	BU ÇİZİM PROFİLSE - SİLAS ORMAN ÜRÜNLERİ'NE AİTTİR. İZINSİZ ÇOĞALTILMAMAK VE KOPYA EDİLMEKEMEK ŞARTI İLE İZİN VERİLMİŞTİR.	PVC ENİ : MDF MİKTARI : PLAKADAN ÇIKAN :	KSM ÖLÇÜCÜ :	KUTU İÇİ : KUTU İÇİ ADET :
ARGE SORUMLUSU DOĞUKAN DEMİR	THIS DRAWING PROFILE - SİLAS FOREST PRODUCTS WHAT TO DO. UNLOCKED AND COPY NOT ALLOWED WITH THE WRITTEN.	GENEL TOLERANS : PROFİL BOY TOLERANSI :	MATERIAL MM MDF	TARİH / DATE 10.10.2018

22 mm Profiles

PROFİLSE - SİLAS ORMAN ÜRÜNLERİ

KAGIT ÜZERİNDEN ÖLÇÜ ALMAYINIZ !!!

ÜRÜN KODU : 22*50
(Product Code)

Don't measurate on paper.

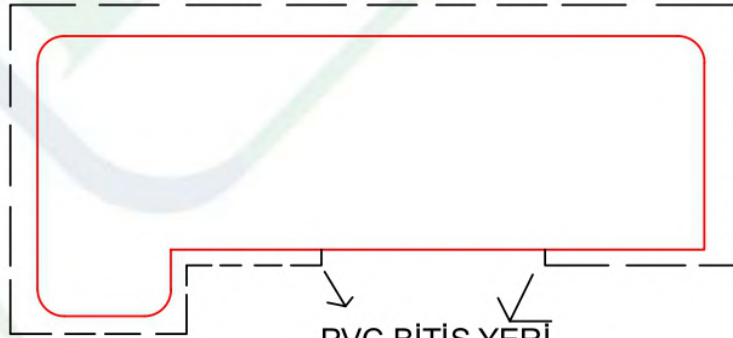
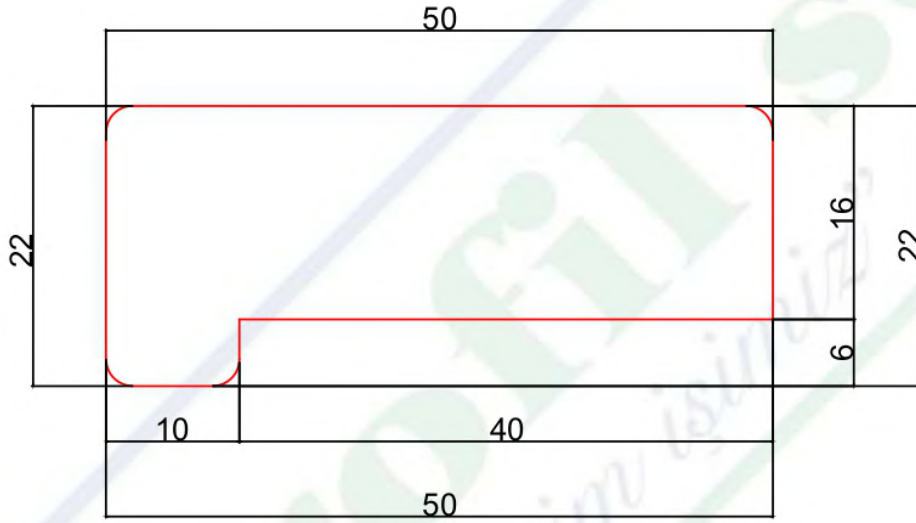

(Pvc ending area)

BÖLÜM SORUMLUSU NEJDET ALTINTOPRAK	BU ÇİZİM PROFİLSE - SİLAS ORMAN ÜRÜNLERİ'NE AİTTİR. İZINSİZ ÇOĞALTILMAMAK VE KOPYA EDİLMEK ŞARTI İLE İZİN VERİLMİŞTİR.	PVC ENİ : MDF MİKTARI : PLAKADAN ÇIKAN :	KSM ÖLÇÜCÜ :	KUTU İÇİ : KUTU İÇİ ADET :
ARGE SORUMLUSU DOĞUKAN DEMİR	THIS DRAWING PROFILE - SILAS FOREST PRODUCTS WHAT TO DO. UNLOCKED AND COPY NOT ALLOWED WITH THE WRITTEN.	GENEL TOLERANS : PROFİL BOY TOLERANSI :	MATERİYAL MM MDF	TARİH / DATE 12.10.2018

22 mm Profiles

PROFİLSE - SİLAS ORMAN ÜRÜNLERİ

KAĞIT ÜZERİNDEN ÖLÇÜ ALMAYINIZ !!!
Don't measure on paper.

ÜRÜN KODU : 22*30

(Product Code)

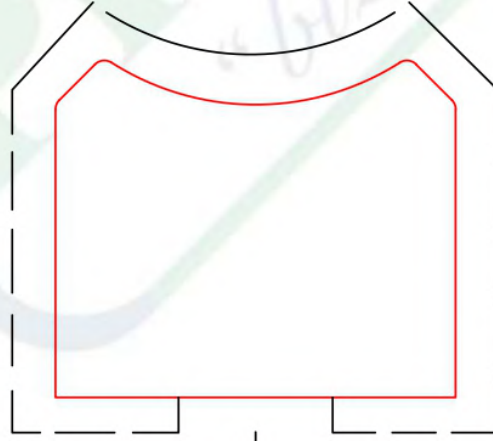
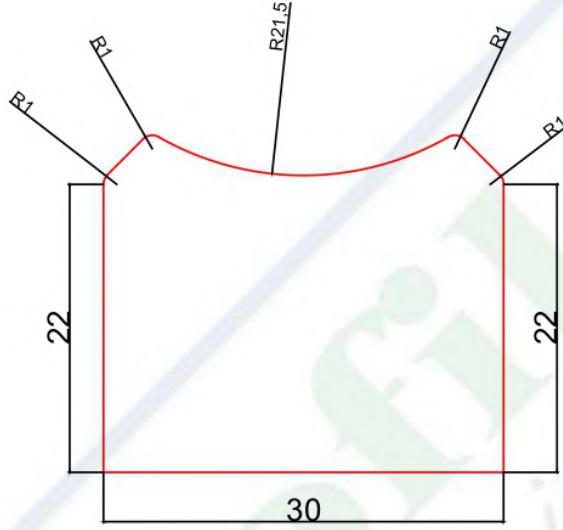

PVC BİTİŞ YERİ
(Pvc ending area)

BÖLÜM SORUMLUSU NEJDET ALTINTOPRAK	BU ÇİZİM PROFİLSE - SİLAS ORMAN ÜRÜNLERİ'NE AİTTİR. İZINSİZ ÇOĞALTILMAMAK VE KOPYA EDİLMEMEK ŞARTI İLE İZİN VERİLMİŞTİR.	PVC ENİ : MDF MIKTARI : PLAKADAN ÇIKAN :	KSM ÖLÇÜCÜ :	KUTU İÇİ : KUTU İÇİ ADET :
ARGE SORUMLUSU DOĞUKAN DEMİR	THIS DRAWING PROFILE - SİLAS FOREST PRODUCTS WHAT TO DO. UNLOCKED AND COPY NOT ALLOWED WITH THE WRITTEN.	GENEL TOLERANS : PROFİL BOY TOLERANSI :	MATERİAL MM MDF	TARİH / DATE 19.12.2018

22 mm Profiles

PROFİLSE - SİLAS ORMAN ÜRÜNLERİ

KAĞIT ÜZERİNDEN ÖLÇÜ ALMAYINIZ !!!

Don't measurate on paper.

ÜRÜN KODU : 22*50

(Product Code)

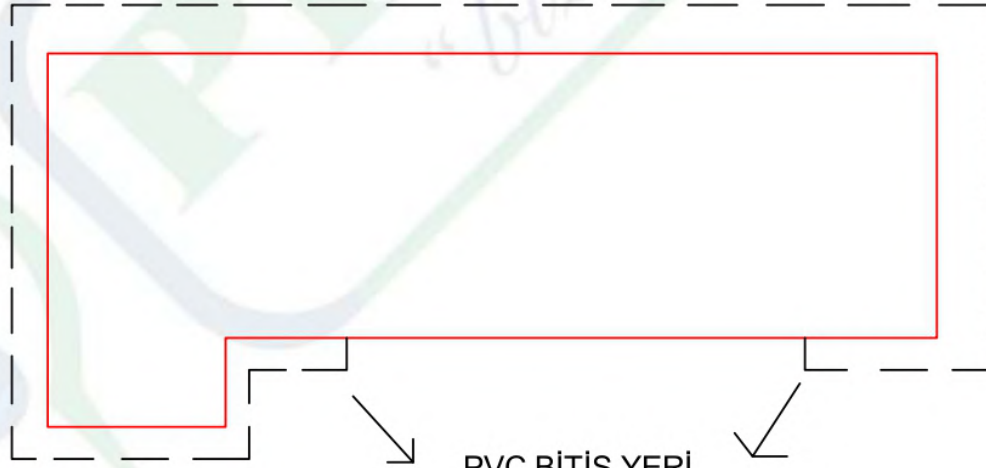

(Pvc ending area)

BÖLÜM SORUMLUSU NEJDET ALTINTOPRAK	BU ÇİZİM PROFİLSE - SİLAS ORMAN ÜRÜNLERİ'NE AİTTİR. İZİNSİZ ÇOĞALTILMAMAK VE KOPYA EDİLMEK ŞARTI İLE İZİN VERİLMİŞTİR.	PVC ENİ : MDF MİKTARI : PLAKADAN ÇIKAN :	KSM ÖLÇÜCÜ :	KUTU İÇİ : KUTU İÇİ ADET :
ARGE SORUMLUSU DOĞUKAN DEMİR	THIS DRAWING PROFILE - SİLAS FOREST PRODUCTS WHAT TO DO. UNLOCKED AND COPY NOT ALLOWED WITH THE WRITTEN.	GENEL TOLERANS : PROFL BOY TOLERANSI :	MATERİYAL MM MDF	TARİH / DATE 20.11.2018

22 mm Profiles

PROFİLSE - SİLAS ORMAN ÜRÜNLERİ

KAĞIT ÜZERİNDEN ÖLÇÜ ALMAYINIZ !!!

Don't measurate on paper.

ÜRÜN KODU : 22*36

(Product Code)

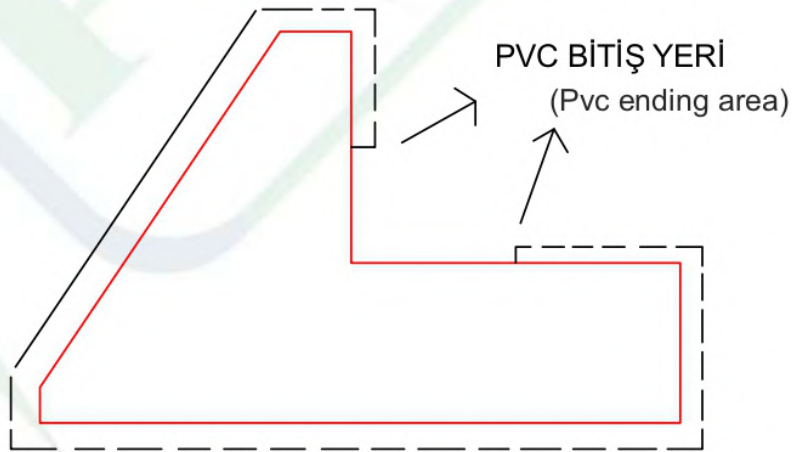
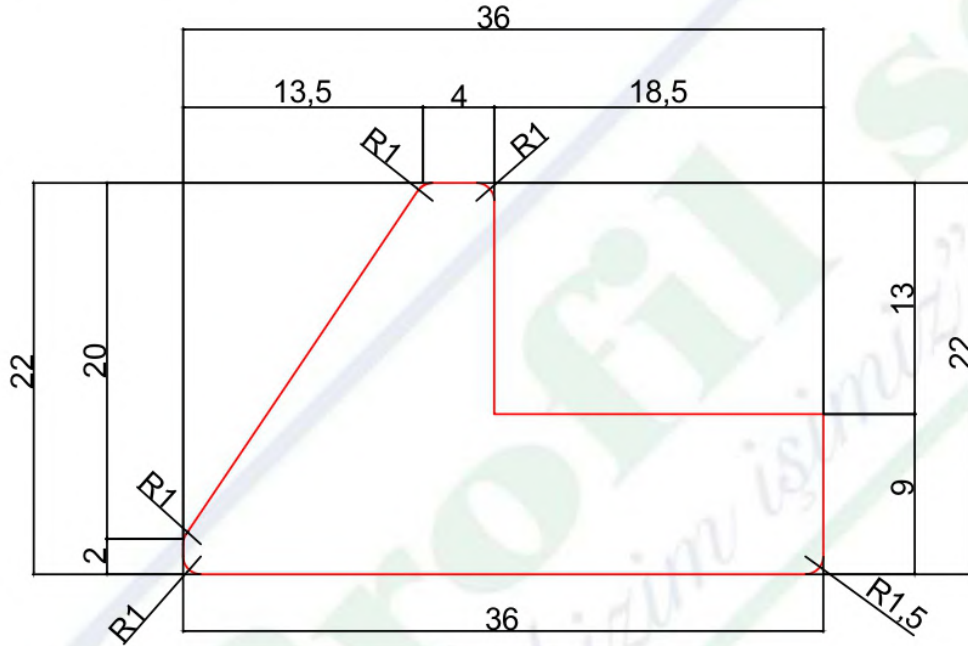

BÖLÜM SORUMLUSU NEJDET ALTINTOPRAK	BU ÇİZİM PROFİLSE - SİLAS ORMAN ÜRÜNLERİ'NE AİTTİR. İZINSİZ ÇOĞALTILMAMAK VE KOPYA EDİLMEMEK ŞARTI İLE İZİN VERİLMİŞTİR.	PVC ENİ : MDF MİKTARI : PLAKADAN ÇIKAN :	KSM ÖLÇÜCÜ :	KUTU İÇİ : KUTU İÇİ ADET :
ARGE SORUMLUSU DOĞUKAN DEMİR	THIS DRAWING PROFILE - SİLAS FOREST PRODUCTS WHAT TO DO. UNLOCKED AND COPY NOT ALLOWED WITH THE WRITTEN.	GENEL TOLERANS : PROFİL BOY TOLERANSI :	MATERİYAL : MM MDF	TARİH / DATE 04.12.2018

22 mm Profiles

PROFİLSE - SİLAS ORMAN ÜRÜNLERİ

(Product Code)

ÜRÜN KODU : 22*50

KAĞIT ÜZERİNDEN ÖLÇÜ ALMAYINIZ !!!

Don't measurate on paper.

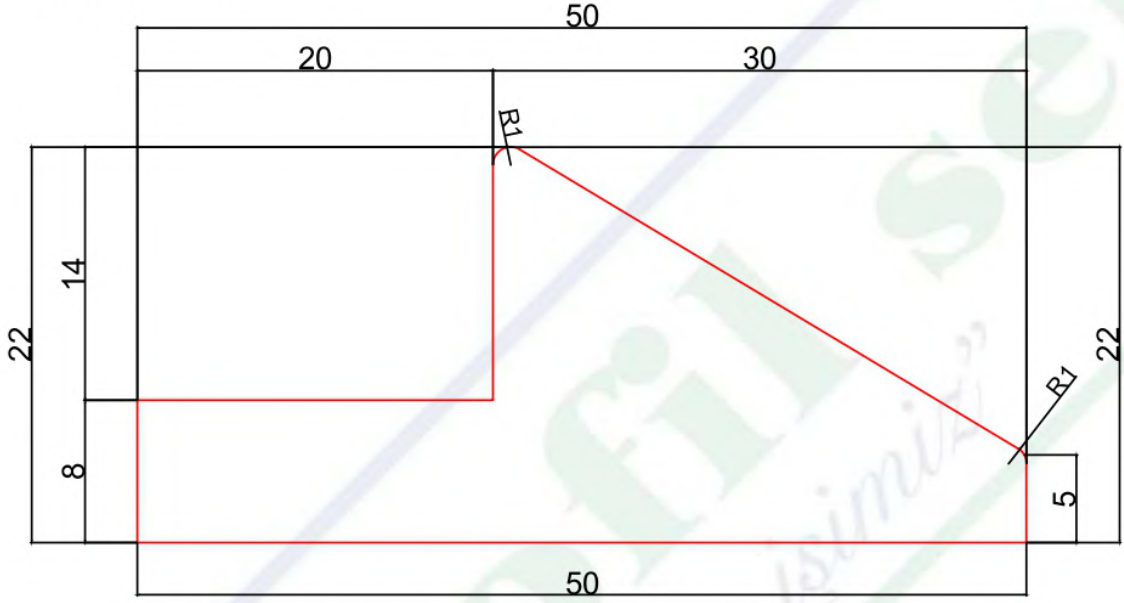

(Pvc ending area)

PVC
BİTİŞ
YERİ

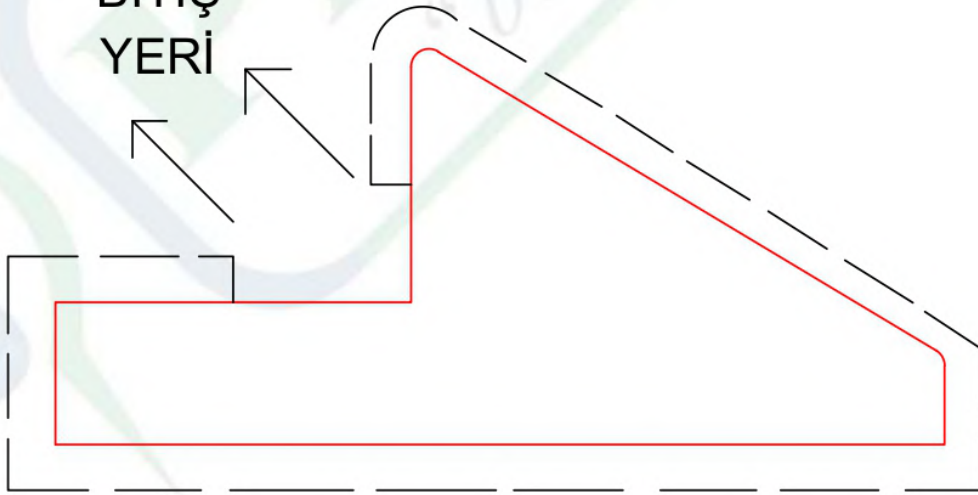

BÖLÜM SORUMLUSU NEJDET ALTINTOPRAK	BU ÇİZİM PROFİLSE - SİLAS ORMAN ÜRÜNLERİ'NE AİTTİR. İZINSİZ ÇOĞALTILMAMAK VE KOPYA EDİLMEMEK ŞARTI İLE İZİN VERİLMİŞTİR.	PVC ENİ : MDF MİKTARI : PLAKADAN ÇIKAN :	KSM ÖLÇÜCÜ :	KUTU İÇİ : KUTU İÇİ ADET :
ARGE SORUMLUSU DOĞUKAN DEMİR	THIS DRAWING PROFILE - SİLAS FOREST PRODUCTS WHAT TO DO. UNLOCKED AND COPY NOT ALLOWED WITH THE WRITTEN.	GENEL TOLERANS : PROFİL BOY TOLERANSI :	MATERIAL MM MDF	TARİH / DATE 07.02.2019

22 mm Profiles

PROFİLSE - SİLAS ORMAN ÜRÜNLERİ

KAĞIT ÜZERİNDEN ÖLÇÜ ALMAYINIZ !!!

Don't measurate on paper.

ÜRÜN KODU : 22*80

(Product Code)

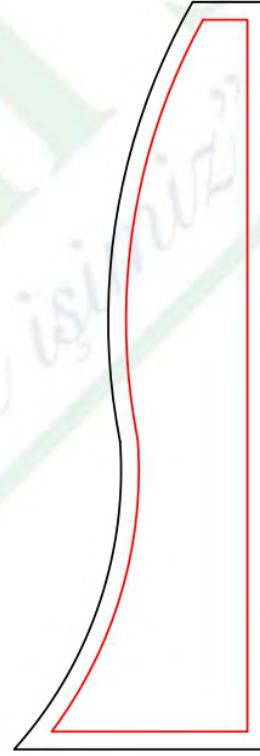
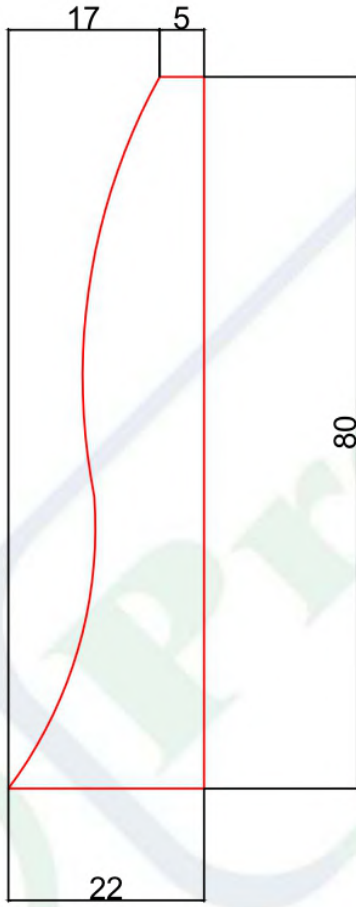

BÖLÜM SORUMLUSU NEJDET ALTINTOPRAK	BU ÇİZİM PROFİLSE - SİLAS ORMAN ÜRÜNLERİ'NE AITTİR. İZINSİZ ÇOĞALTILMAMAK VE KOPYA EDİLMEMEK ŞARTI İLE İZİN VERİLMİŞTİR.	PVC ENİ : MDF MİKTARI : PLAKADAN ÇIKAN :	KSM ÖLÇÜCÜ :	KUTU İÇİ : KUTU İÇİ ADET :
ARGE SORUMLUSU DOĞUKAN DEMİR	THIS DRAWING PROFILE - SİLAS FOREST PRODUCTS WHAT TO DO. UNLOCKED AND COPY NOT ALLOWED WITH THE WRITTEN.	GENEL TOLERANS : PROFL BOY TOLERANSI :	MATERİAL MM MDF	TARİH / DATE 09.11.2018

25 mm Profiles

PROFİLSE - SİLAS ORMAN ÜRÜNLERİ

KAĞIT ÜZERİNDEN ÖLÇÜ ALMAYINIZ !!!
Don't measurate on paper.

ÜRÜN KODU : 25*44
(Product Code)

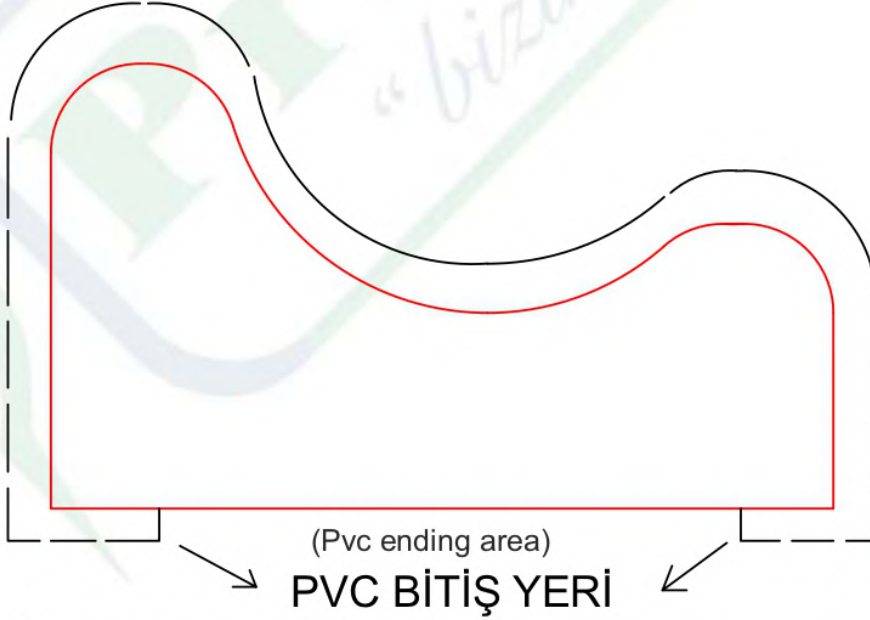
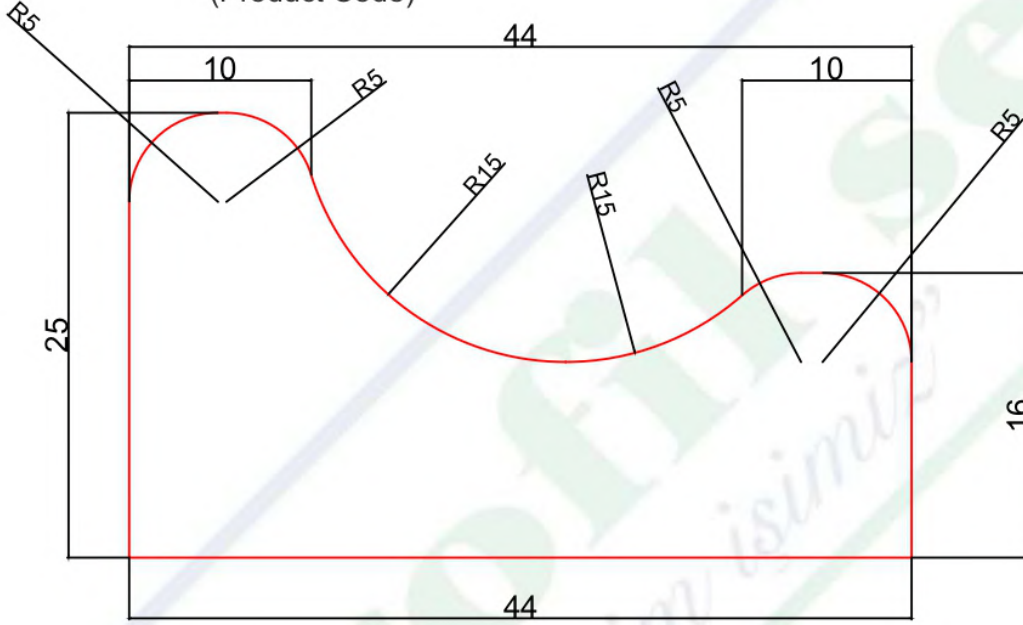

BÖLÜM SORUMLUSU NEJDET ALTINTOPRAK	BU ÇİZİM PROFİLSE - SİLAS ORMAN ÜRÜNLERİ'NE AİTTİR. İZINSİZ ÇOĞALTILMAMAK VE KOPYA EDİLMEMEK ŞARTI İLE İZİN VERİLMİŞTİR.	PVC ENİ : MDF MİKTARI : PLAKADAN ÇIKAN :	KSM ÖLÇÜCÜ :	KUTU İÇİ : KUTU İÇİ ADET :
ARGE SORUMLUSU DOĞUKAN DEMİR	THIS DRAWING PROFILE - SİLAS FOREST PRODUCTS WHAT TO DO. UNLOCKED AND COPY NOT ALLOWED WITH THE WRITTEN.	GENEL TOLERANS : PROFİL BOY TOLERANSI :	MATERİYAL : MM MDF	TARİH / DATE 01.03.2019

25 mm Profiles

PROFİLSE - SİLAS ORMAN ÜRÜNLERİ

ÜRÜN KODU : 25*50
(Product Code)

KAĞIT ÜZERİNDEN ÖLÇÜ ALMAYINIZ !!!
Don't measure on paper.

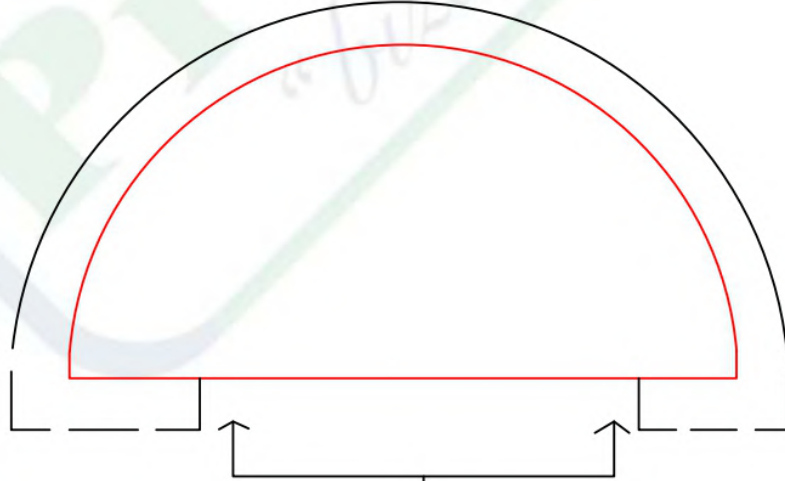
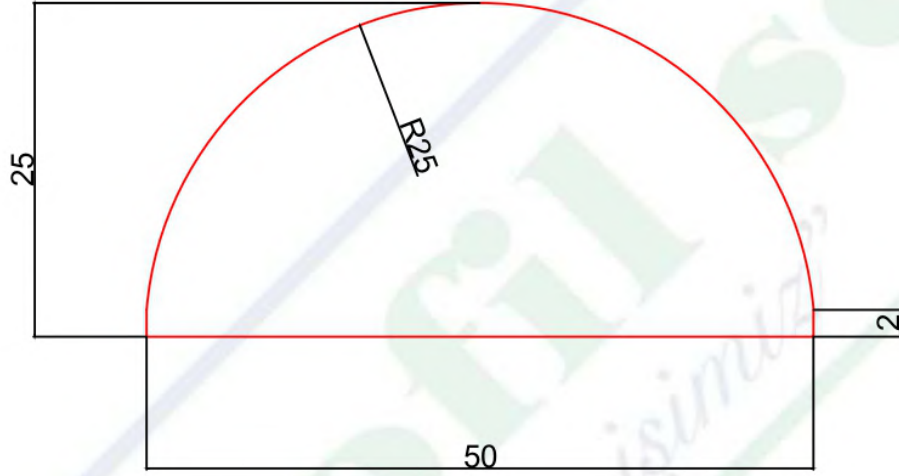

PVC BİTİŞ YERİ
(Pvc ending area)

BÖLÜM SORUMLUSU NEJDET ALTINTOPRAK	BU ÇİZİM PROFİLSE - SİLAS ORMAN ÜRÜNLERİ'NE AİTTİR. İZINSİZ ÇOĞALTILMAMAK VE KOPYA EDİLMEMEK ŞARTI İLE İZİN VERİLMİŞTİR.	PVC ENİ : MDF MİKTARI : PLAKADAN ÇIKAN :	KSM ÖLÇÜCÜ :	KUTU İÇİ : KUTU İÇİ ADET :
ARGE SORUMLUSU DOĞUKAN DEMİR	THIS DRAWING PROFILE - SİLAS FOREST PRODUCTS WHAT TO DO. UNLOCKED AND COPY NOT ALLOWED WITH THE WRITTEN.	GENEL TOLERANS : PROFİL BOY TOLERANSI :	MATERİYAL MM MDF	TARİH / DATE 04.10.2018

25 mm Profiles

PROFİLSE - SİLAS ORMAN ÜRÜNLERİ

KAĞIT ÜZERİNDEN ÖLÇÜ ALMAYINIZ !!!

Don't measurate on paper.

ÜRÜN KODU : 25*70

(Product Code)

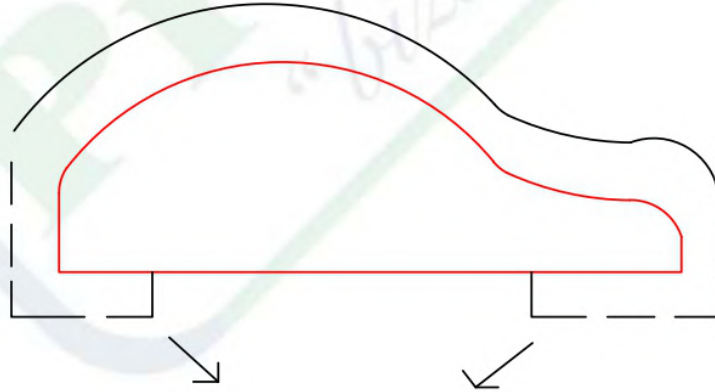
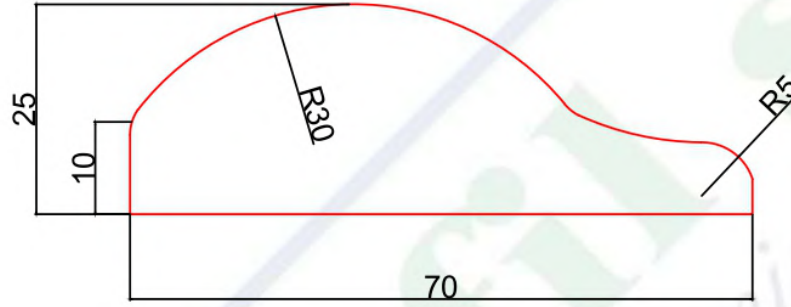

PVC BİTİŞ YERİ
(Pvc ending area)

BÖLÜM SORUMLUSU NEJDET ALTINTOPRAK	BU ÇİZİM PROFİLSE - SİLAS ORMAN ÜRÜNLERİ'NE AITTİR. İZINSİZ ÇOĞALTILMAMAK VE KOPYA EDİLMEMEK ŞARTI İLE İZİN VERİLMİŞTİR.	PVC ENİ : MDF MİKTARI : PLAKADAN ÇIKAN :	KSM ÖLÇÜCÜ :	KUTU İÇİ : KUTU İÇİ ADET :
ARGE SORUMLUSU DOĞUKAN DEMİR	THIS DRAWING PROFILE - SİLAS FOREST PRODUCTS WHAT TO DO. UNLOCKED AND COPY NOT ALLOWED WITH THE WRITTEN.	GENEL TOLERANS : PROFİL BOY TOLERANSI :	MATERİYAL MM MDF	TARİH / DATE 10.10.2018

25 mm Profiles

PROFİLSE - SİLAS ORMAN ÜRÜNLERİ

KAĞIT ÜZERİNDEN ÖLÇÜ ALMAYINIZ !!!

ÜRÜN KODU : 25*75
(Product Code)

Don't measurate on paper.

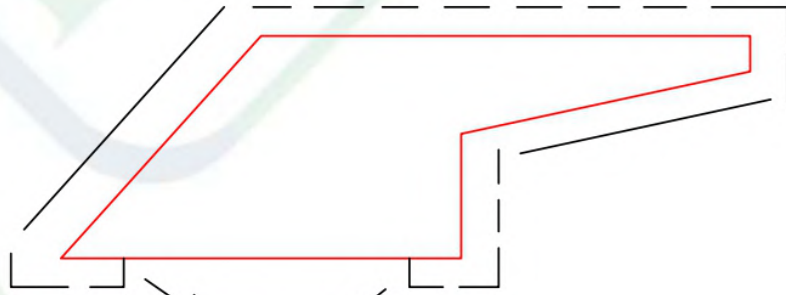
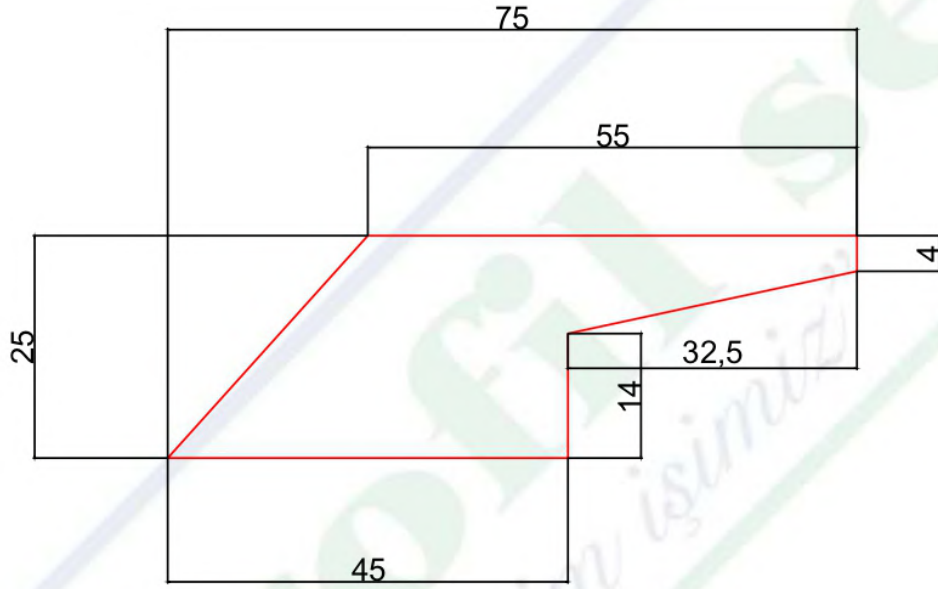

PVC BİTİŞ YERİ
(Pvc ending area)

BÖLÜM SORUMLUSU NEJDET ALTINTOPRAK	BU ÇİZİM PROFİLSE - SİLAS ORMAN ÜRÜNLERİ'NE AİTTİR. İZİNSİZ ÇOĞALTILMAMAK VE KOPYA EDİLMEKEMEK ŞARTI İLE İZİN VERİLMİŞTİR.	PVC ENİ : MDF MİKTARI : PLAKADAN ÇIKAN :	KSM ÖLÇÜCÜ :	KUTU İÇİ : KUTU İÇİ ADET :
ARGE SORUMLUSU DOĞUKAN DEMİR	THIS DRAWING PROFILE - SİLAS FOREST PRODUCTS WHAT TO DO. UNLOCKED AND COPY NOT ALLOWED WITH THE WRITTEN.	GENEL TOLERANS : PROFİL BOY TOLERANSI :	MATERİYAL MM MDF	TARİH / DATE 03.10.2018

25 mm Profiles

PROFİLSE - SİLAS ORMAN ÜRÜNLERİ

KAĞIT ÜZERİNDEN ÖLÇÜ ALMAYINIZ !!!

ÜRÜN KODU : 25*50
(Product Code)

Don't measurate on paper.

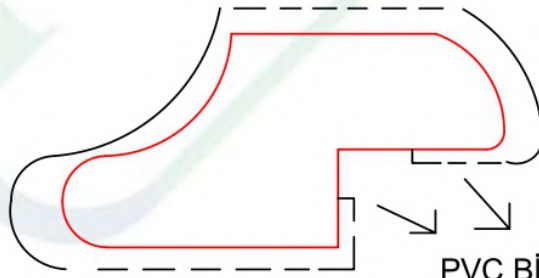
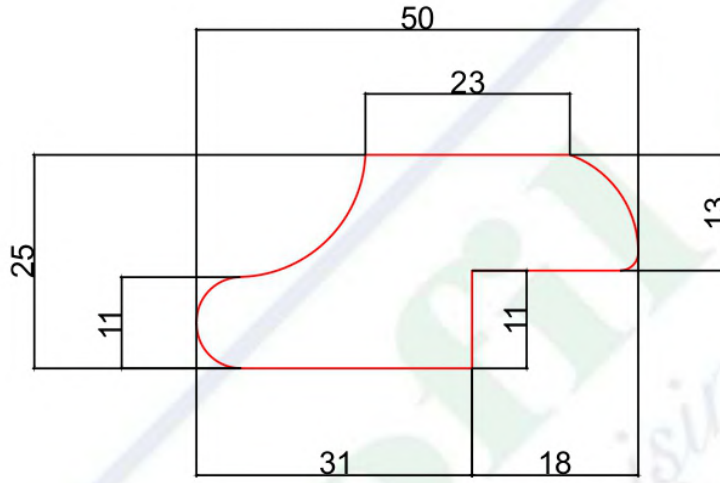

PVC BITİŞ YERİ
(Pvc ending area)

BÖLÜM SORUMLUSU NEJDET ALTINTOPRAK	BU ÇİZİM PROFİLSE - SİLAS ORMAN ÜRÜNLERİ'NE AİTTİR. İZİNSİZ ÇOĞALTILMAMAK VE KOPYA EDİLMEMEK ŞARTI İLE İZİN VERİLMİŞTİR.	PVC ENİ : MDF MİKTARI : PLAKADAN ÇIKAN :	KSM ÖLÇÜCÜ :	KUTU İÇİ : KUTU İÇİ ADET :
ARGE SORUMLUSU DOĞUKAN DEMİR	THIS DRAWING PROFILE - SİLAS FOREST PRODUCTS WHAT TO DO. UNLOCKED AND COPY NOT ALLOWED WITH THE WRITTEN.	GENEL TOLERANS : PROFİL BOY TOLERANSI :	MATERIAL MM MDF	TARİH / DATE 03.10.2018

25 mm Profiles

PROFİLSE - SİLAS ORMAN ÜRÜNLERİ

KAĞIT ÜZERİNDEN ÖLÇÜ ALMAYINIZ !!!
Don't measure on paper.

ÜRÜN KODU : 25*80
(Product Code)

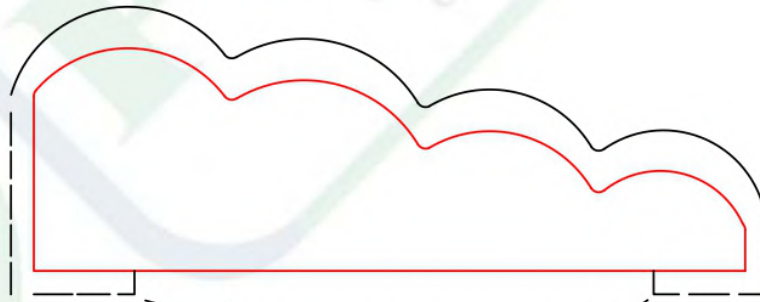
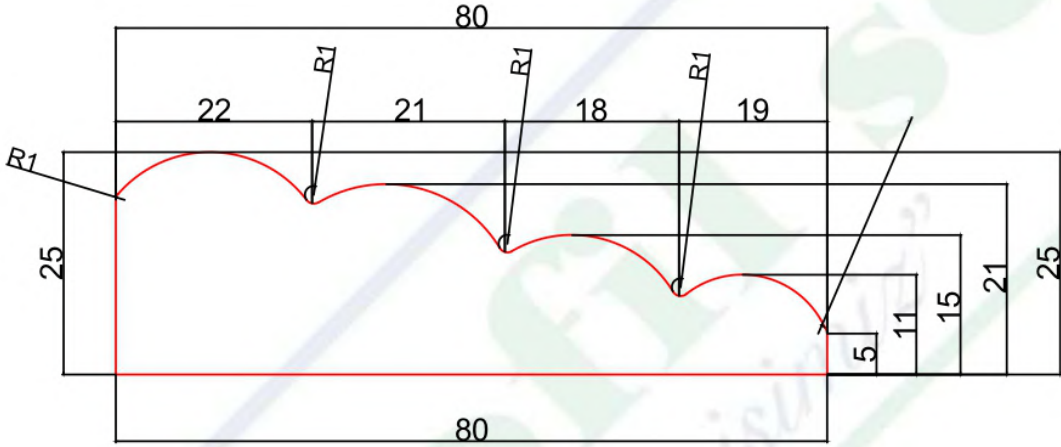

PVC BITİŞ YERİ
(Pvc ending area)

BÖLÜM SORUMLUSU NEJDET ALTINTOPRAK	BU ÇİZİM PROFİLSE - SİLAS ORMAN ÜRÜNLERİ'NE AİTTİR. İZINSİZ ÇOĞALTILMAMAK VE KOPYA EDİLMEMEK ŞARTI İLE İZİN VERİLMİŞTİR.	PVC ENİ : MDF MİKTARI : PLAKADAN ÇIKAN :	KSM ÖLÇÜCÜ :	KUTU İÇİ : KUTU İÇİ ADET :
ARGE SORUMLUSU DOĞUKAN DEMİR	THIS DRAWING PROFILE - SİLAS FOREST PRODUCTS WHAT TO DO. UNLOCKED AND COPY NOT ALLOWED WITH THE WRITTEN.	GENEL TOLERANS : PROFİL BOY TOLERANSI :	MATERİYAL MM MDF	TARİH / DATE 08.03.2019

25 mm Profiles

PROFİLSE - SİLAS ORMAN ÜRÜNLERİ

KAĞIT ÜZERİNDEN ÖLÇÜ ALMAYINIZ !!!
Don't measure on paper.

ÜRÜN KODU : 25*62
(Product Code)

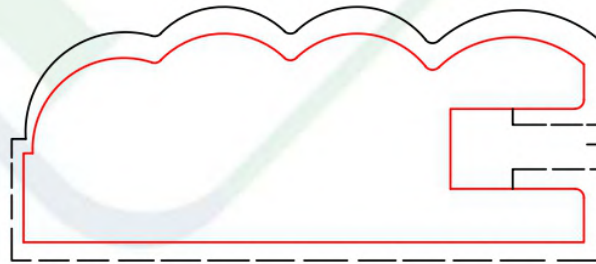
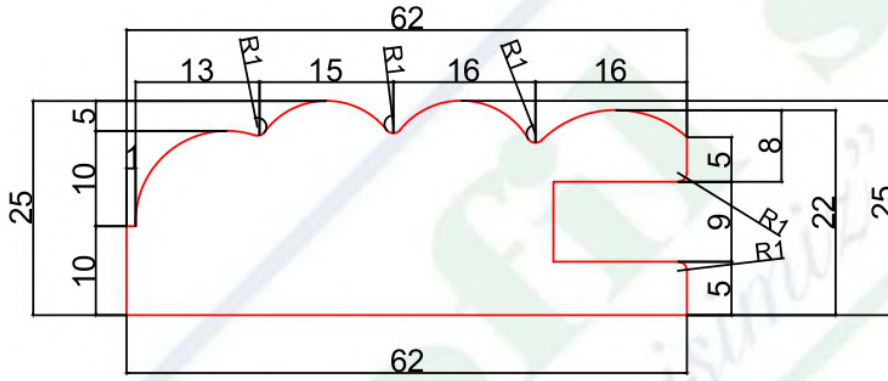

PVC
BİTİŞ
YERİ
(Pvc ending area)

BÖLÜM SORUMLUSU NEJDET ALTINTOPRAK	BU ÇİZİM PROFİLSE - SİLAS ORMAN ÜRÜNLERİ'NE AİTTİR. İZINSİZ ÇOĞALTILMAMAK VE KOPYA EDİLMEK ŞARTI İLE İZİN VERİLMİŞTİR.	PVC ENİ : MDF MİKTARI : PLAKADAN ÇIKAN :	KSM ÖLÇÜCÜ :	KUTU İÇİ : KUTU İÇİ ADET :
ARGE SORUMLUSU DOĞUKAN DEMİR	THIS DRAWING PROFILE - SILAS FOREST PRODUCTS WHAT TO DO. UNLOCKED AND COPY NOT ALLOWED WITH THE WRITTEN.	GENEL TOLERANS : PROFİL BOY TOLERANSI :	MATERİYAL MM MDF	TARİH / DATE 08.03.2019

25 mm Profiles

PROFİLSE - SİLAS ORMAN ÜRÜNLERİ

KAĞIT ÜZERİNDEN ÖLÇÜ ALMAYINIZ !!!

Don't measurate on paper.

ÜRÜN KODU : 25*25

(Product Code)

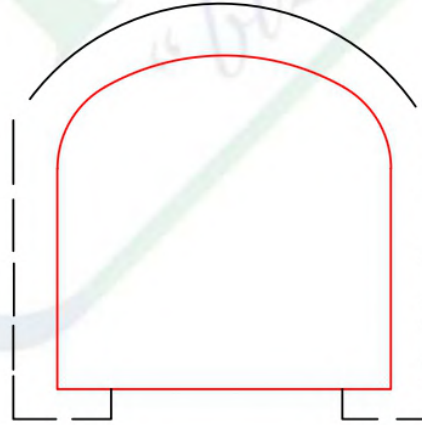
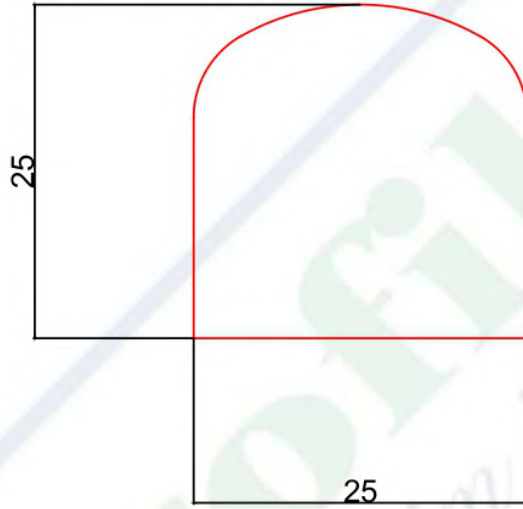

PVC BİTİŞ YERİ
(Pvc ending area)

BÖLÜM SORUMLUSU NEJDET ALTINTOPRAK	BU ÇİZİM PROFİLSE - SİLAS ORMAN ÜRÜNLERİ'NE AİTTİR. İZINSİZ ÇOĞALTILMAMAK VE KOPYA EDİLMEK ŞARTI İLE İZİN VERİLMİŞTİR.	PVC ENİ : MDF MİKTARI : PLAKADAN ÇIKAN :	KSM ÖLÇÜCÜ :	KUTU İÇİ : KUTU İÇİ ADET :
ARGE SORUMLUSU DOĞUKAN DEMİR	THIS DRAWING PROFILE - SİLAS FOREST PRODUCTS WHAT TO DO. UNLOCKED AND COPY NOT ALLOWED WITH THE WRITTEN.	GENEL TOLERANS : PROFL BOY TOLERANSI :	MATERİAL MM MDF	TARİH / DATE 10.09.2018

25 mm Profiles

PROFİLSE - SİLAS ORMAN ÜRÜNLERİ

KAĞIT ÜZERİNDEN ÖLÇÜ ALMAYINIZ !!!

Don't measure on paper.

ÜRÜN KODU: 25*43

(Product Code)

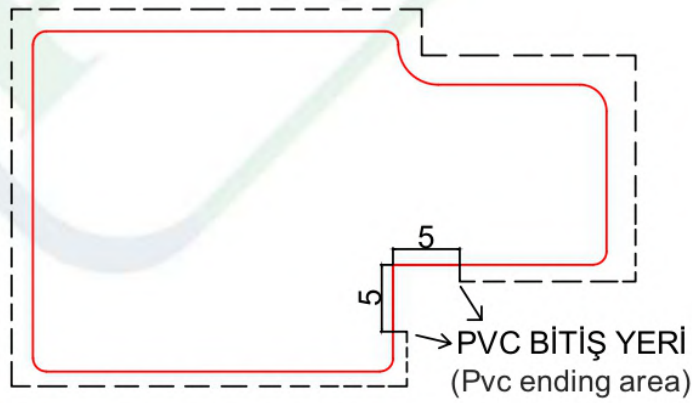
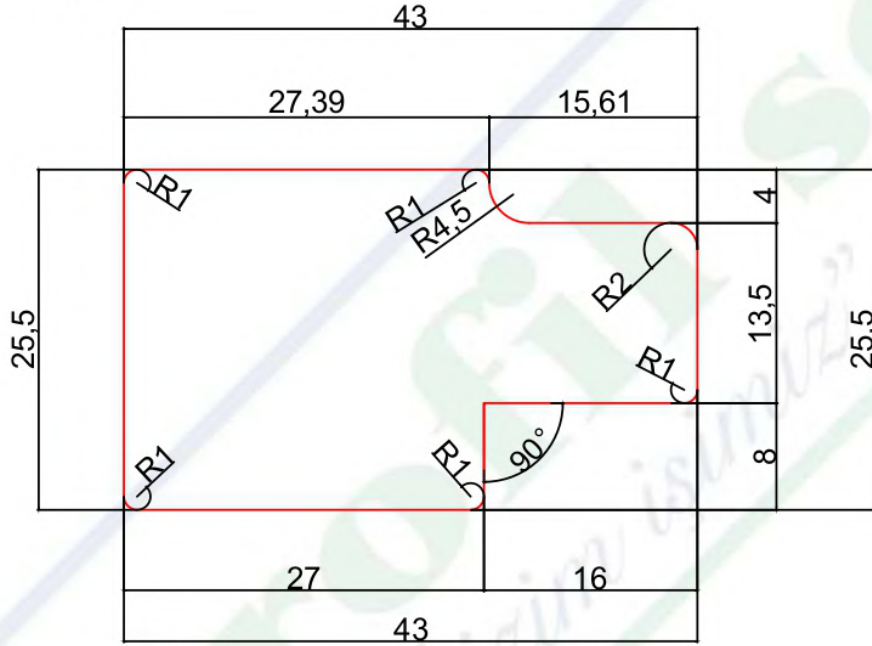

BÖLÜM SORUMLUSU NEJDET ALTINTOPRAK	BU ÇİZİM PROFİLSE - SİLAS ORMAN ÜRÜNLERİ 'NE AİTTİR. İZİNSİZ ÇOĞALTILMAMAK VE KOPYA EDİLMEKEMEK ŞARTI İLE İZİN VERİLMİŞTİR.	PVC ENİ MDF MİKTARI PLAKADAN ÇIKAN	KSM ÖLÇÜCÜ	KUTU İÇİ KUTU İÇİ ADET
ARGE SORUMLUSU DOĞUKAN DEMİR	THIS DRAWING PROFILE - SİLAS FOREST PRODUCTS WHAT TO DO. UNLOCKED AND COPY NOT ALLOWED WITH THE WRITTEN.	GENEL TOLERANS PROFİL BOY TOLERANSI	MATERİYAL MM MDF	TARİH / DATE 10.12.2018

25 mm Profiles

PROFİLSE - SİLAS ORMAN ÜRÜNLERİ

KAĞIT ÜZERİNDEN ÖLÇÜ ALMAYINIZ !!!
Don't measure on paper.

ÜRÜN KODU : 25*50

(Product Code)

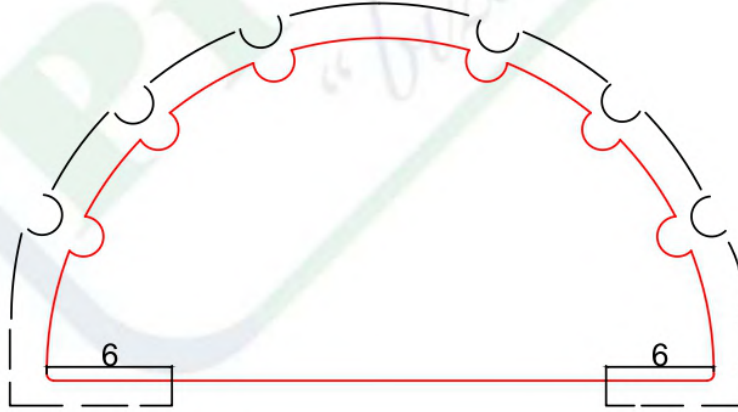
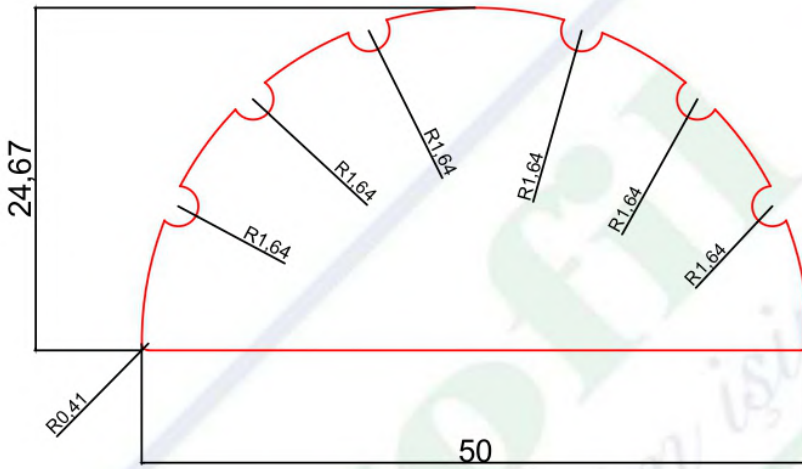

PVC BİTİŞ YERİ
(Pvc ending area)

BÖLÜM SORUMLUSU NEJDET ALTINTOPRAK	BU ÇİZİM PROFİLSE - SİLAS ORMAN ÜRÜNLERİ'NE AİTTİR. İZINSİZ ÇOĞALTILMAMAK VE KOPYA EDİLMEMEK ŞARTI İLE İZİN VERİLMİŞTİR.	PVC ENİ : MDF MİKTARI : PLAKADAN ÇIKAN :	KSM ÖLÇÜCÜ :	KUTU İÇİ : KUTU İÇİ ADET :
ARGE SORUMLUSU DOĞUKAN DEMİR	THIS DRAWING PROFILE - SİLAS FOREST PRODUCTS WHAT TO DO. UNLOCKED AND COPY NOT ALLOWED WITH THE WRITTEN.	GENEL TOLERANS : PROFİL BOY TOLERANSI :	MATERİYAL MM MDF	TARİH / DATE 10.12.2018

25 mm Profiles

PROFİLSE - SİLAS ORMAN ÜRÜNLERİ

KAĞIT ÜZERİNDEN ÖLÇÜ ALMAYINIZ !!!

Don't measure on paper.

ÜRÜN KODU : 25*35-02

(Product Code)

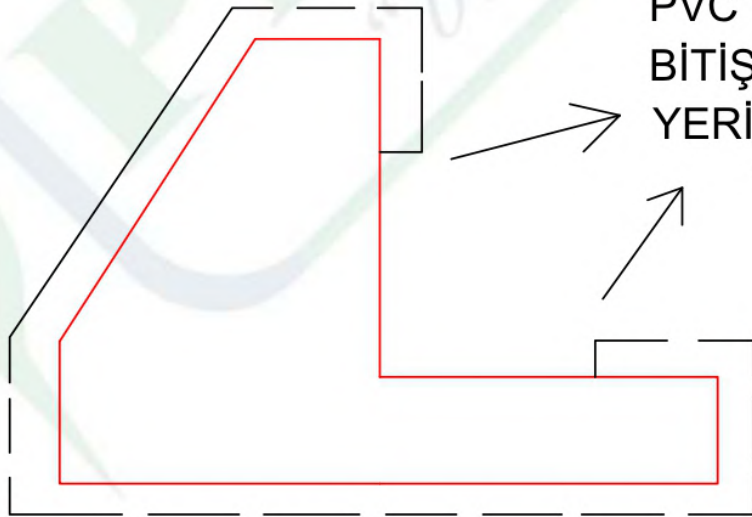
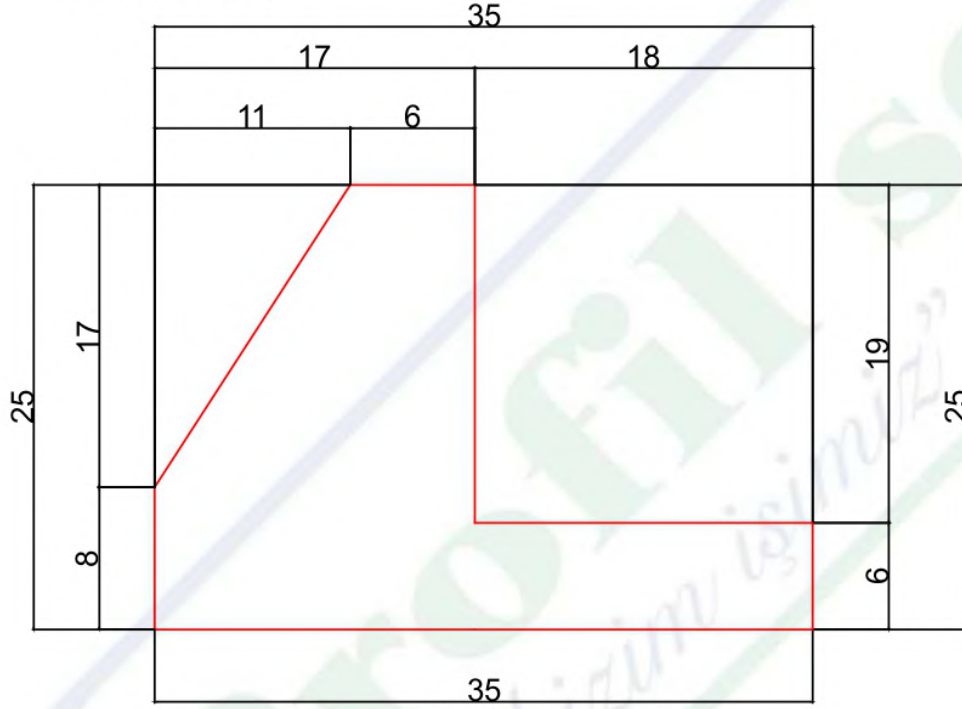

PVC
BİTİŞ
YERİ

(Pvc ending area)

BÖLÜM SORUMLUSU NEJDET ALTINTOPRAK	BU ÇİZİM PROFİLSE - SİLAS ORMAN ÜRÜNLERİ'NE AİTTİR. İZINSİZ ÇOĞALTILMAMAK VE KOPYA EDİLMEMEK ŞARTI İLE İZİN VERİLMİŞTİR.	PVC ENİ : MDF MİKTARI : PLAKADAN ÇIKAN :	KSM ÖLÇÜCÜ :	KUTU İÇİ : KUTU İÇİ ADET :
ARGE SORUMLUSU DOĞUKAN DEMİR	THIS DRAWING PROFILE - SİLAS FOREST PRODUCTS WHAT TO DO. UNLOCKED AND COPY NOT ALLOWED WITH THE WRITTEN.	GENEL TOLERANS : PROFİL BOY TOLERANSI :	MATERİYAL MM MDF	TARİH / DATE 03.04.2019

25 mm Profiles

PROFİLSE - SİLAS ORMAN ÜRÜNLERİ

KAĞIT ÜZERİNDEN ÖLÇÜ ALMAYINIZ !!!
Don't measure on paper.

ÜRÜN KODU : 25*75

(Product Code)

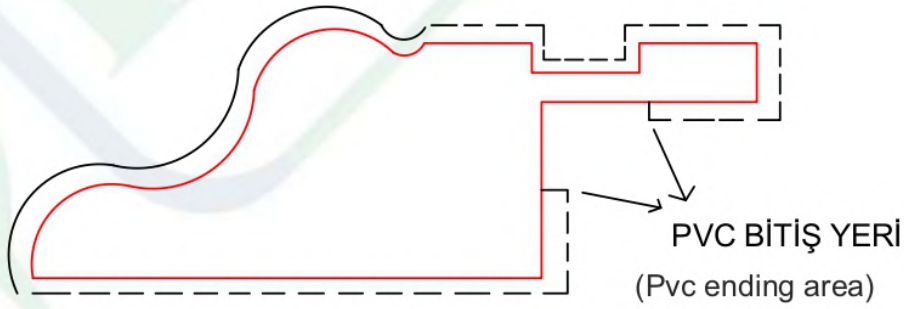
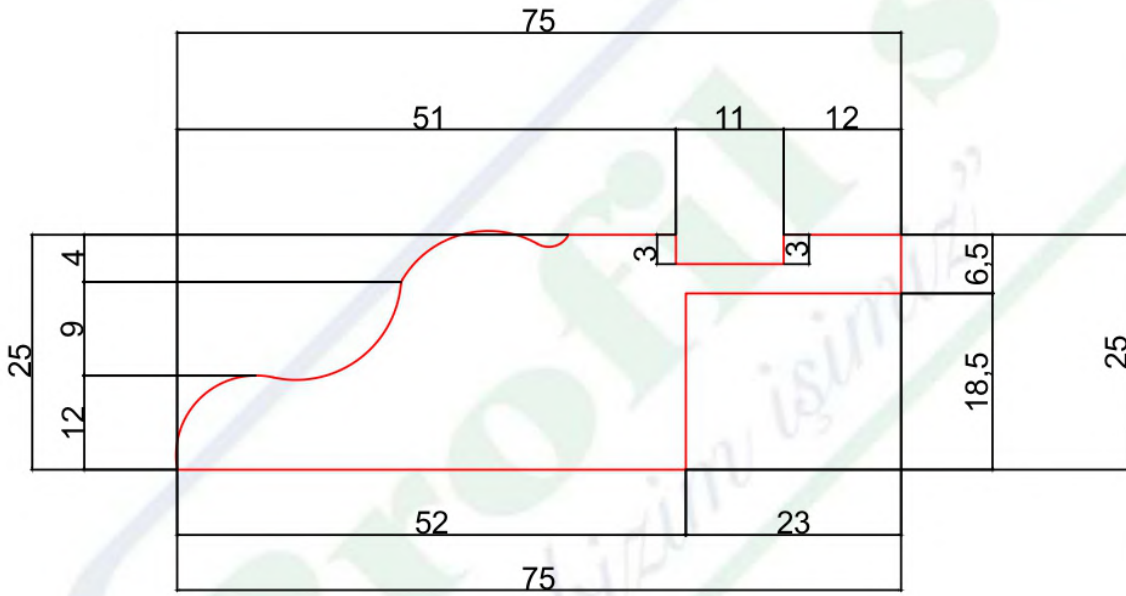

BÖLÜM SORUMLUSU NEJDET ALTINTOPRAK	BU ÇİZİM PROFİLSE - SİLAS ORMAN ÜRÜNLERİ'NE AİTTİR. İZINSİZ ÇOĞALTILMAMAK VE KOPYA EDİLMEKEMEK ŞARTI İLE İZİN VERİLMİŞTİR.	PVC ENİ : MDF MİKTARI : PLAKADAN ÇIKAN :	KSM ÖLÇÜCÜ :	KUTU İÇİ : KUTU İÇİ ADET :
ARGE SORUMLUSU DOĞUKAN DEMİR	THIS DRAWING PROFILE - SİLAS FOREST PRODUCTS WHAT TO DO. UNLOCKED AND COPY NOT ALLOWED WITH THE WRITTEN.	GENEL TOLERANS : PROFİL BOY TOLERANSI :	MATERIAL MM MDF	TARİH / DATE 19.11.2018

25 mm Profiles

PROFİLSE - SİLAS ORMAN ÜRÜNLERİ

KAĞIT ÜZERİNDEN ÖLÇÜ ALMAYINIZ !!!

Don't measurate on paper.

ÜRÜN KODU : 25*52
(Product Code)

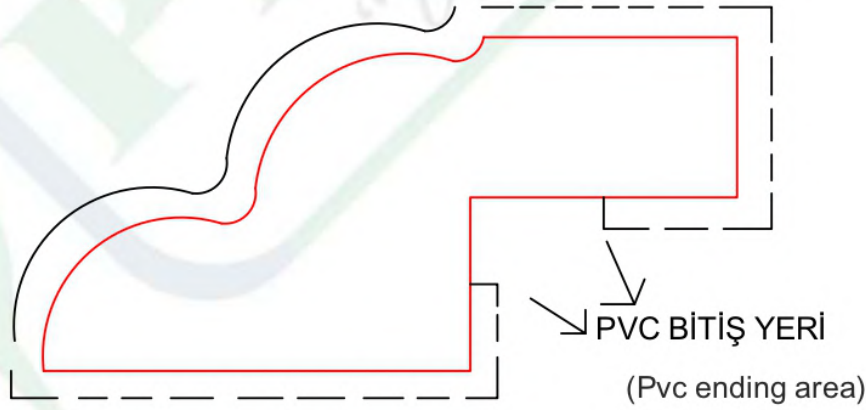
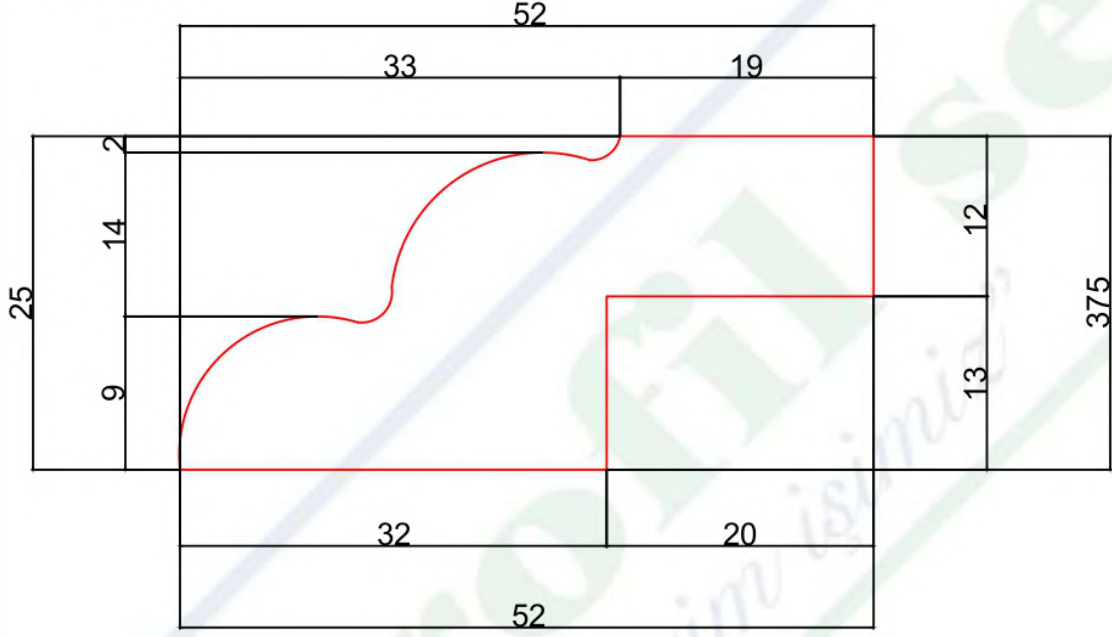

BÖLÜM SORUMLUSU NEJDET ALTINTOPRAK	BU ÇİZİM PROFİLSE - SİLAS ORMAN ÜRÜNLERİ'NE AİTTİR. İZİNSİZ ÇOĞALTILMAMAK VE KOPYA EDİLMEYEMEK ŞARTI İLE İZİN VERİLMİŞTİR.	PVC ENİ : MDF MİKTARI : PLAKADAN ÇIKAN :	KSM ÖLÇÜCÜ :	KUTU İÇİ : KUTU İÇİ ADET :
ARGE SORUMLUSU DOĞUKAN DEMİR	THIS DRAWING PROFILE - SİLAS FOREST PRODUCTS WHAT TO DO. UNLOCKED AND COPY NOT ALLOWED WITH THE WRITTEN.	GENEL TOLERANS : PROFİL BOY TOLERANSI :	MATERİYAL MM MDF	TARİH / DATE 19.11.2018

25 mm Profiles

PROFİLSE - SİLAS ORMAN ÜRÜNLERİ

KAĞIT ÜZERİNDEN ÖLÇÜ ALMAYINIZ !!!

ÜRÜN KODU : 25*80

Don't measurate on paper.

(Product Code)

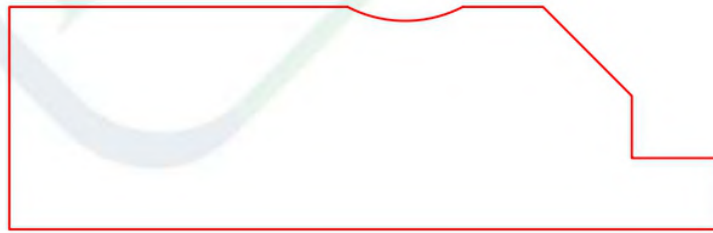
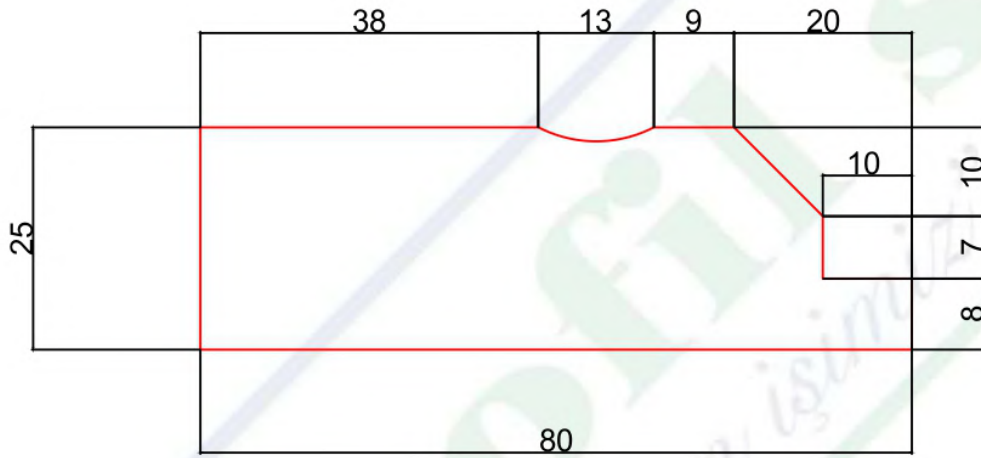

BÖLÜM SORUMLUSU NEJDET ALTINTOPRAK	BU ÇİZİM PROFİLSE - SİLAS ORMAN ÜRÜNLERİ'NE AİTTİR. İZINSİZ ÇOĞALTILMAMAK VE KOPYA EDİLMEK ŞARTI İLE İZİN VERİLMİŞTİR.	PVC ENİ : MDF MİKTARI : PLAKADAN ÇIKAN :	KSM ÖLÇÜCÜ :	KUTU İÇİ : KUTU İÇİ ADET :
ARGE SORUMLUSU DOĞUKAN DEMİR	THIS DRAWING PROFILE - SİLAS FOREST PRODUCTS WHAT TO DO. UNLOCKED AND COPY NOT ALLOWED WITH THE WRITTEN.	GENEL TOLERANS : PROFL BOY TOLERANSI :	MATERİYAL MM MDF	TARİH / DATE 03.10.2018

25 mm Profiles

PROFİLSE - SİLAS ORMAN ÜRÜNLERİ

KAĞIT ÜZERİNDEN ÖLÇÜ ALMAYINIZ !!!

Don't measurate on paper.

ÜRÜN KODU : 25*30
(Product Code)

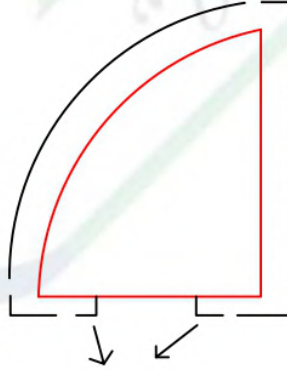
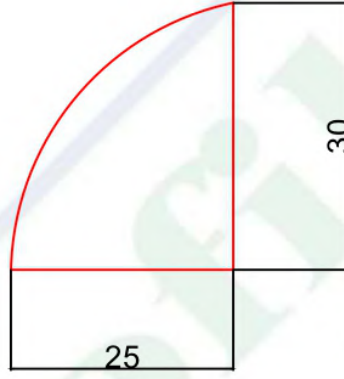

PVC BİTİŞ YERİ

(Pvc ending area)

BÖLÜM SORUMLUSU NEJDET ALTINTOPRAK	BU ÇİZİM PROFİLSE - SİLAS ORMAN ÜRÜNLERİ'NE AİTTİR. İZINSİZ ÇOĞALTILMAMAK VE KOPYA EDİLMEKEMEK ŞARTI İLE İZİN VERİLMİŞTİR.	PVC ENİ : MDF MİKTARI : PLAKADAN ÇIKAN :	KSM ÖLÇÜCÜ :	KUTU İÇİ : KUTU İÇİ ADET :
ARGE SORUMLUSU DOĞUKAN DEMİR	THIS DRAWING PROFILE - SİLAS FOREST PRODUCTS WHAT TO DO. UNLOCKED AND COPY NOT ALLOWED WITH THE WRITTEN.	GENEL TOLERANS : PROFİL BOY TOLERANSI :	MATERIAL MM MDF	TARİH / DATE 10.09.2018

25 mm Profiles

PROFİLSE - SİLAS ORMAN ÜRÜNLERİ

ÜRÜN KODU : 25*80

(Product Code)

KAĞIT ÜZERİNDEN ÖLÇÜ ALMAYINIZ !!!

Don't measurate on paper.

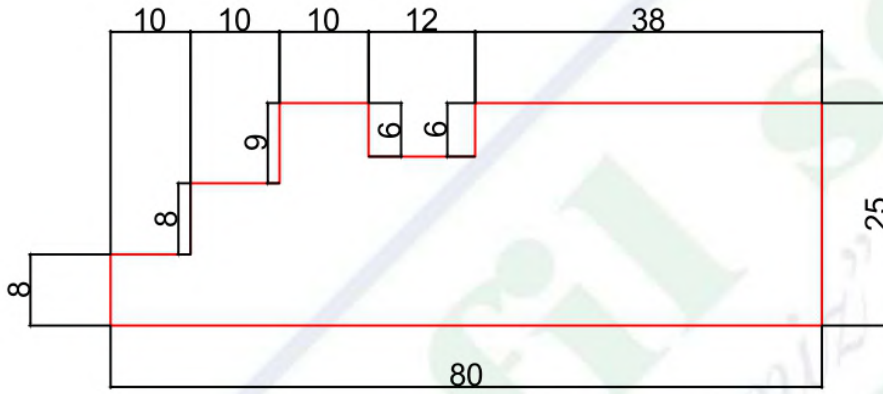

BÖLÜM SORUMLUSU NEJDET ALTINTOPRAK	BU ÇİZİM PROFİLSE - SİLAS ORMAN ÜRÜNLERİ'NE AİTTİR. İZINSİZ ÇOĞALTILMAMAK VE KOPYA EDİLMEK ŞARTI İLE İZİN VERİLMİŞTİR.	PVC ENİ : MDF MİKTARI : PLAKADAN ÇIKAN :	KSM ÖLÇÜCÜ :	KUTU İÇİ : KUTU İÇİ ADET :
ARGE SORUMLUSU DOĞUKAN DEMİR	THIS DRAWING PROFILE - SILAS FOREST PRODUCTS WHAT TO DO. UNLOCKED AND COPY NOT ALLOWED WITH THE WRITTEN.	GENEL TOLERANS : PROFİL BOY TOLERANSI :	MATERİYAL MM MDF	TARİH / DATE 03.10.2018

25 mm Profiles

PROFİLSE - SİLAS ORMAN ÜRÜNLERİ

KAĞIT ÜZERİNDEN ÖLÇÜ ALMAYINIZ !!!

Don't measurate on paper.

ÜRÜN KODU : 25*52-02

(Product Code)

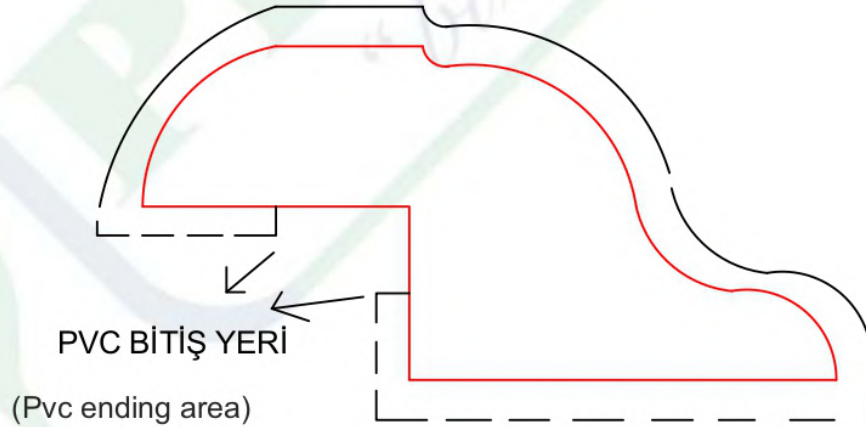
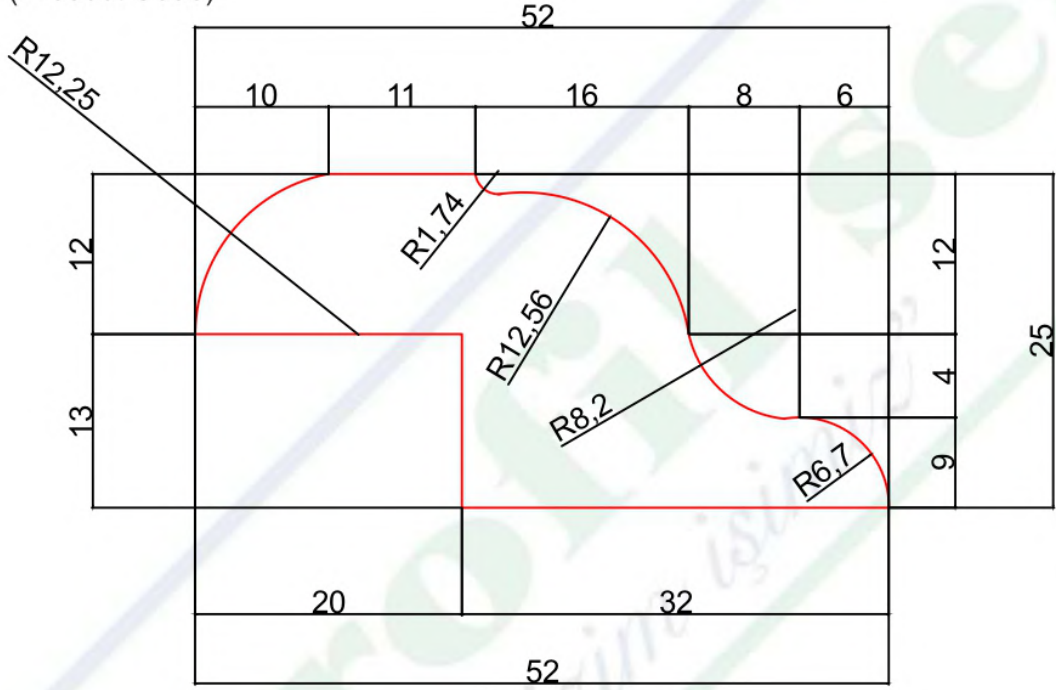

BÖLÜM SORUMLUSU NEJDET ALTINTOPRAK	BU ÇİZİM PROFİLSE - SİLAS ORMAN ÜRÜNLERİ'NE AİTTİR. İZINSİZ ÇOĞALTILMAMAK VE KOPYA EDİLMEKEMEK ŞARTI İLE İZİN VERİLMİŞTİR.	PVC ENİ : MDF MİKTARI : PLAKADAN ÇIKAN :	KSM ÖLÇÜCÜ :	KUTU İÇİ : KUTU İÇİ ADET :
ARGE SORUMLUSU DOĞUKAN DEMİR	THIS DRAWING PROFILE - SİLAS FOREST PRODUCTS WHAT TO DO. UNLOCKED AND COPY NOT ALLOWED WITH THE WRITTEN.	GENEL TOLERANS : PROFİL BOY TOLERANSI :	MATERİYAL : MM MDF	TARİH / DATE 19.11.2018

25 mm Profiles

PROFİLSE - SİLAS ORMAN ÜRÜNLERİ

KAĞIT ÜZERİNDEN ÖLÇÜ ALMAYINIZ !!!
Don't measurate on paper.

ÜRÜN KODU : 25*36

(Product Code)

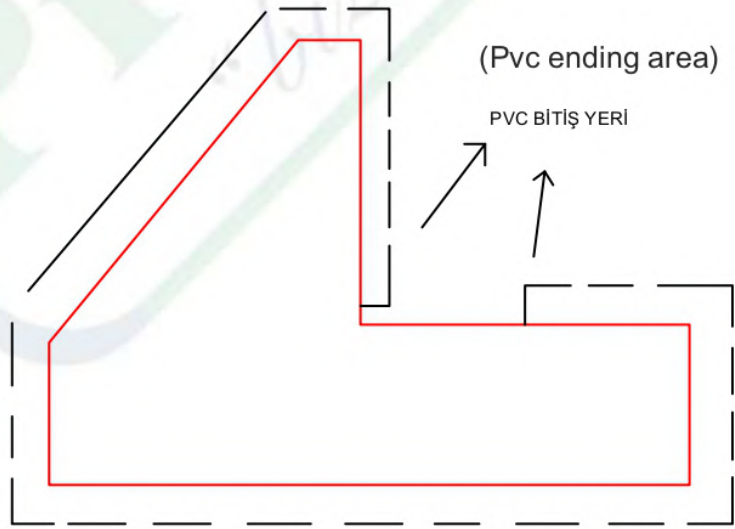
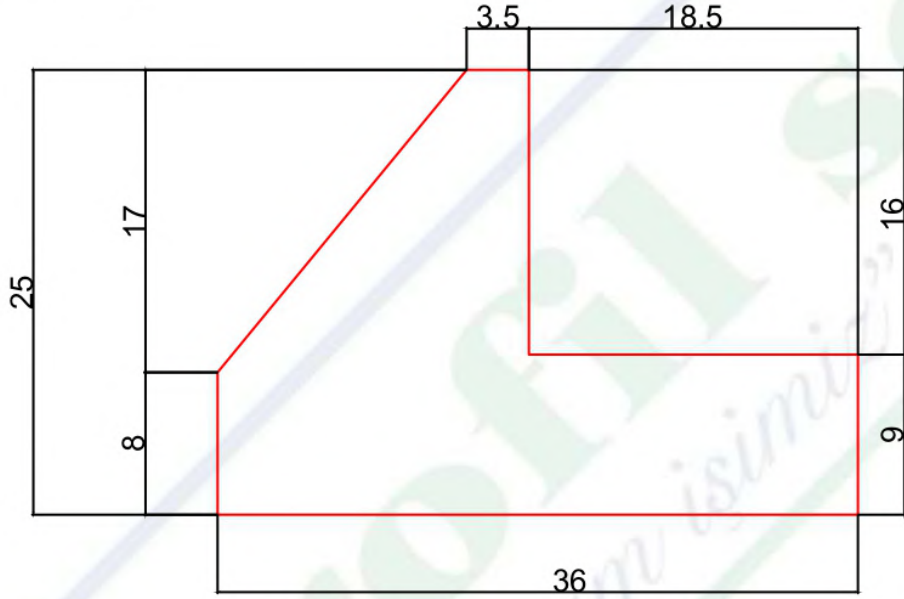

BÖLÜM SORUMLUSU NEJDET ALTINTOPRAK	BU ÇİZİM PROFİLSE - SİLAS ORMAN ÜRÜNLERİ'NE AİTTİR. İZINSİZ ÇOĞALTILMAMAK VE KOPYA EDİLMEKEMEK ŞARTI İLE İZİN VERİLMİŞTİR.	PVC ENİ : MDF MIKTARI : PLAKADAN ÇIKAN :	KSM ÖLÇÜCÜ :	KUTU İÇİ : KUTU İÇİ ADET :
ARGE SORUMLUSU DOĞUKAN DEMİR	THIS DRAWING PROFILE - SİLAS FOREST PRODUCTS WHAT TO DO. UNLOCKED AND COPY NOT ALLOWED WITH THE WRITTEN.	GENEL TOLERANS : PROFİL BOY TOLERANSI :	MATERİYAL MM MDF	TARİH / DATE 04.10.2018

25 mm Profiles

PROFİLSE - SİLAS ORMAN ÜRÜNLERİ

KAĞIT ÜZERİNDEN ÖLÇÜ ALMAYINIZ !!!

Don't measurate on paper.

ÜRÜN KODU : 25*25
(Product Code)

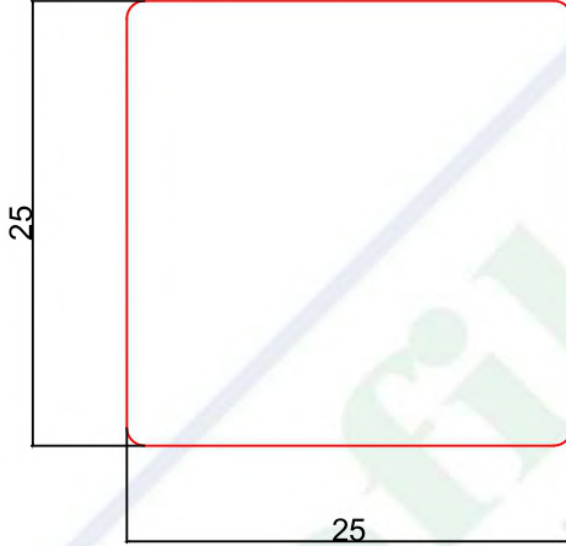

PVC BİTİŞ YERİ
(Pvc ending area)

BÖLÜM SORUMLUSU NEJDET ALTINTOPRAK	BU ÇİZİM PROFİLSE - SİLAS ORMAN ÜRÜNLERİ NE AİTTİR. İZINSİZ ÇOĞALTILMAMAK VE KOPYA EDİLMEMEK ŞARTI İLE İZİN VERİLMİŞTİR.	PVC ENİ : MDF MİKTARI : PLAKADAN ÇIKAN :	KSM ÖLÇÜCÜ :	KUTU İÇİ : KUTU İÇİ ADET :
ARGE SORUMLUSU DOĞUKAN DEMİR	THIS DRAWING PROFILE - SİLAS FOREST PRODUCTS WHAT TO DO. UNLOCKED AND COPY NOT ALLOWED WITH THE WRITTEN.	GENEL TOLERANS : PROFL BOY TOLERANSI :	MATERIAL MM MDF	TARİH / DATE 10.10.2018

25 mm Profiles

PROFİLSE - SİLAS ORMAN ÜRÜNLERİ

KAĞIT ÜZERİNDEN ÖLÇÜ ALMAYINIZ !!!

Don't measurate on paper.

ÜRÜN KODU 25*50
(Product Code)

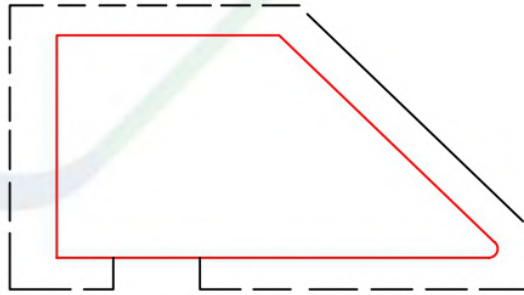
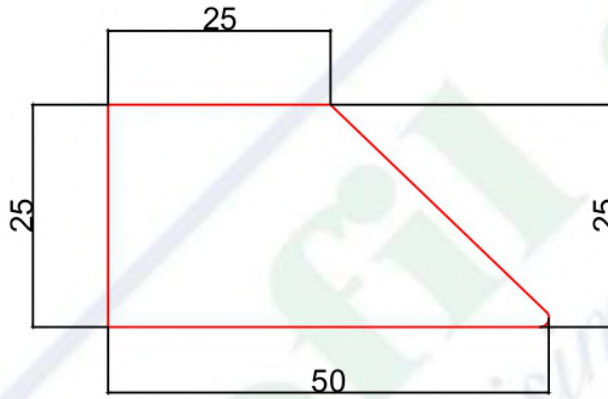

PVC BİTİŞ YERİ
(Pvc ending area)

BÖLÜM SORUMLUSU NEJDET ALTINTOPRAK	BU ÇİZİM PROFİLSE - SİLAS ORMAN ÜRÜNLERİ'NE AİTTİR. İZİNSİZ ÇOĞALTILMAMAK VE KOPYA EDİLMEMEK ŞARTI İLE İZİN VERİLMİŞTİR.	PVC ENİ : MDF MİKTARI : PLAKADAN ÇIKAN :	KSM ÖLÇÜCÜ :	KUTU İÇİ : KUTU İÇİ ADET :
ARGE SORUMLUSU DOĞUKAN DEMİR	THIS DRAWING PROFILE - SİLAS FOREST PRODUCTS WHAT TO DO. UNLOCKED AND COPY NOT ALLOWED WITH THE WRITTEN.	GENEL TOLERANS : PROFİL BOY TOLERANSI :	MATERİYAL MM MDF	TARİH / DATE 10.10.2018

25 mm Profiles

PROFİLSE - SİLAS ORMAN ÜRÜNLERİ

KAĞIT ÜZERİNDEN ÖLÇÜ ALMAYINIZ !!!

Don't measurate on paper.

ÜRÜN KODU : 25*35-04

(Product Code)

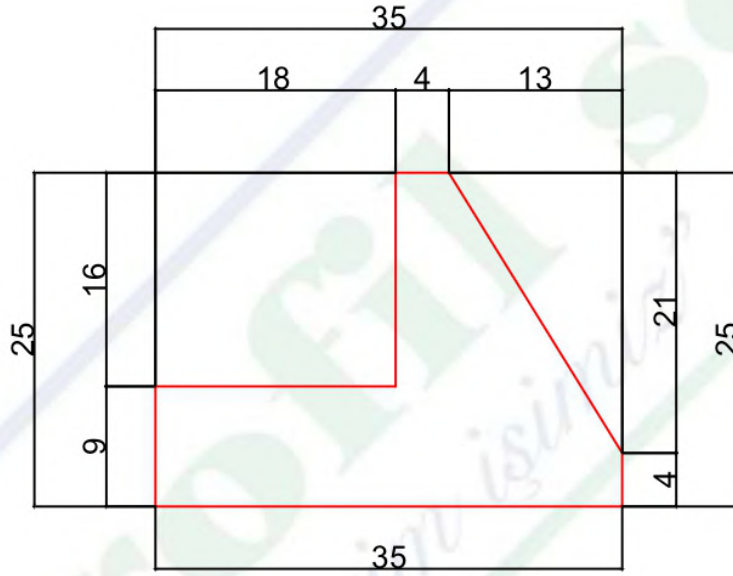

(Pvc ending area)

PVC BİTİŞ YERİ

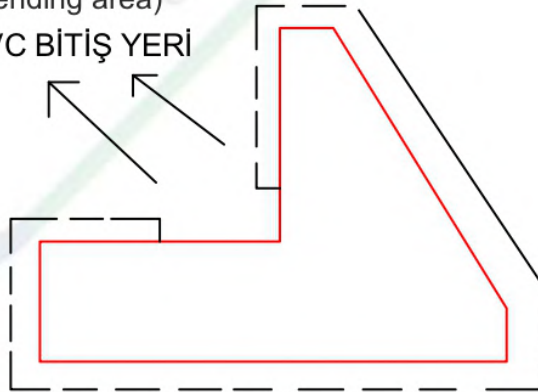

BÖLÜM SORUMLUSU NEJDET ALTINTOPRAK	BU ÇİZİM PROFİLSE - SİLAS ORMAN ÜRÜNLERİ'NE AITTIR. İZINSİZ ÇOĞALTILMAMAK VE KOPYA EDİLMEYEMEK ŞARTI İLE İZİN VERİLMİŞTİR.	PVC ENİ : MDF MİKTARI : PLAKADAN ÇIKAN :	KSM ÖLÇÜCÜ :	KUTU İÇİ : KUTU İÇİ ADET :
ARGE SORUMLUSU DOĞUKAN DEMİR	THIS DRAWING PROFILE - SİLAS FOREST PRODUCTS WHAT TO DO. UNLOCKED AND COPY NOT ALLOWED WITH THE WRITTEN.	GENEL TOLERANS : PROFİL BOY TOLERANSI :	MATERİYAL MM MDF	TARİH / DATE 10.10.2018

25 mm Profiles

PROFİLSE - SİLAS ORMAN ÜRÜNLERİ

KAĞIT ÜZERİNDEN ÖLÇÜ ALMAYINIZ !!!

Don't measure on paper.

ÜRÜN KODU : 25*35

(Product Code)

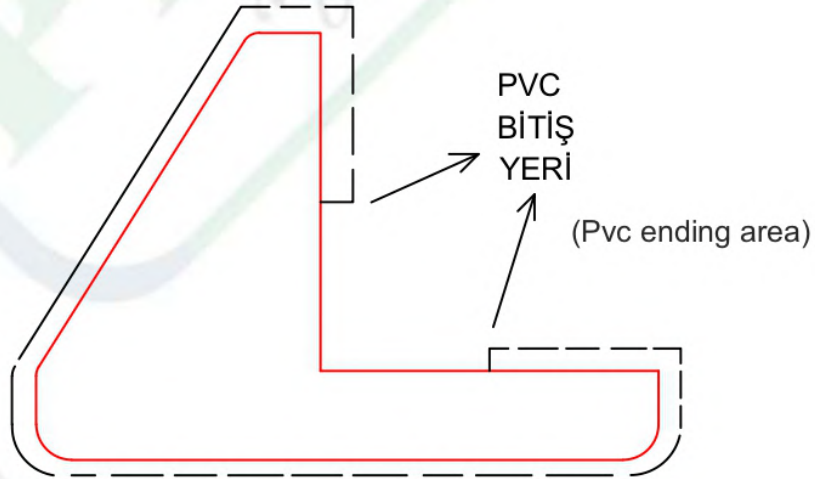
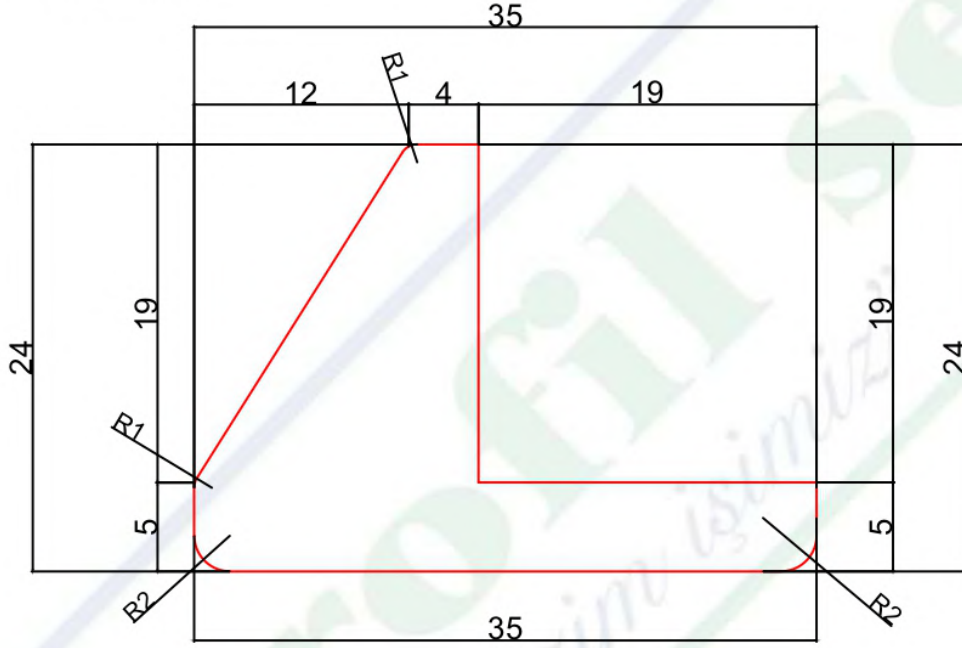

BÖLÜM SORUMLUSU NEJDET ALTINTOPRAK	BU ÇİZİM PROFİLSE - SİLAS ORMAN ÜRÜNLERİ'NE AİTTİR. İZINSİZ ÇOĞALTILMAMAK VE KOPYA EDİLMEMEK ŞARTI İLE İZİN VERİLMİŞTİR.	PVC ENİ : MDF MİKTARI : PLAKADAN ÇIKAN :	KSM ÖLÇÜCÜ :	KUTU İÇİ : KUTU İÇİ ADET :
ARGE SORUMLUSU DOĞUKAN DEMİR	THIS DRAWING PROFILE - SİLAS FOREST PRODUCTS WHAT TO DO. UNLOCKED AND COPY NOT ALLOWED WITH THE WRITTEN.	GENEL TOLERANS : PROFİL BOY TOLERANSI :	MATERİYAL MM MDF	TARİH / DATE 16.04.2019

25 mm Profiles

PROFİLSE - SİLAS ORMAN ÜRÜNLERİ

KAĞIT ÜZERİNDEN ÖLÇÜ ALMAYINIZ !!!
Don't measure on paper.

ÜRÜN KODU : 25*55
(Product Code)

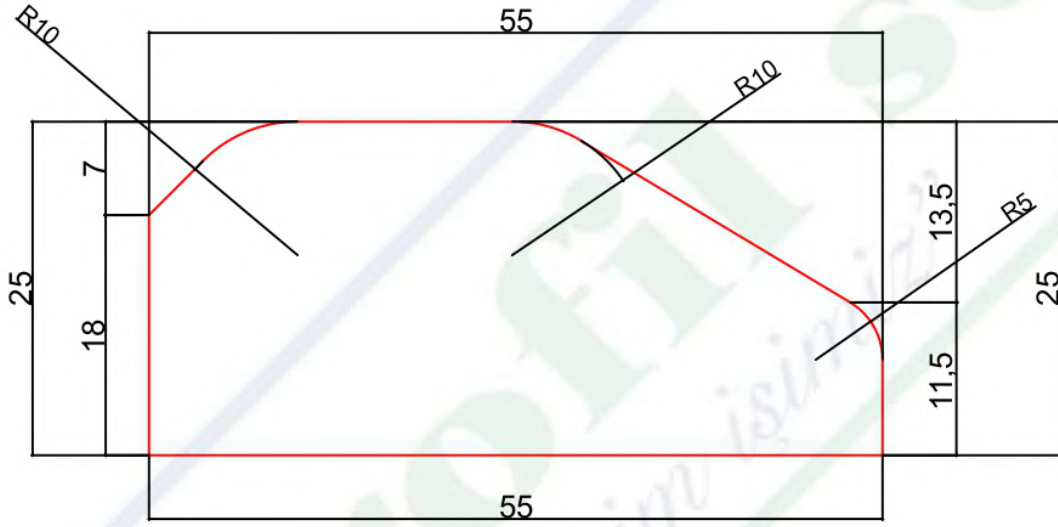

PVC BİTİŞ YERİ
(Pvc ending area)

BÖLÜM SORUMLUSU NEJDET ALTINTOPRAK	BU ÇİZİM PROFİLSE - SİLAS ORMAN ÜRÜNLERİ'NE AİTTİR. İZINSİZ ÇOĞALTILMAMAK VE KOPYA EDİLMEMEK ŞARTI İLE İZİN VERİLMİŞTİR.	PVC ENİ : MDF MİKTARI : PLAKADAN ÇIKAN :	KSM ÖLÇÜCÜ :	KUTU İÇİ : KUTU İÇİ ADET :
ARGE SORUMLUSU DOĞUKAN DEMİR	THIS DRAWING PROFILE - SİLAS FOREST PRODUCTS WHAT TO DO. UNLOCKED AND COPY NOT ALLOWED WITH THE WRITTEN.	GENEL TOLERANS : PROFİL BOY TOLERANSI :	MATERİYAL MM MDF	TARİH / DATE 24.01.2019

25 mm Profiles

PROFİLSE - SİLAS ORMAN ÜRÜNLERİ

KAĞIT ÜZERİNDEN ÖLÇÜ ALMAYINIZ !!!

Don't measurate on paper.

ÜRÜN KODU : 25*65

(Product Code)

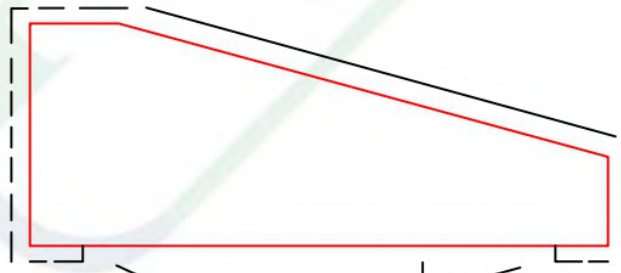

PVC BİTİŞ YERİ
(Pvc ending area)

BÖLÜM SORUMLUSU NEJDET ALTINTOPRAK	BU ÇİZİM PROFİLSE - SİLAS ORMAN ÜRÜNLERİ'NE AİTTİR. İZINSİZ ÇOĞALTILMAMAK VE KOPYA EDİLMEMEK ŞARTI İLE İZİN VERİLMİŞTİR.	PVC ENİ : MDF MİKTARI : PLAKADAN ÇIKAN :	KSM ÖLÇÜCÜ :	KUTU İÇİ : KUTU İÇİ ADET :
ARGE SORUMLUSU DOĞUKAN DEMİR	THIS DRAWING PROFILE - SİLAS FOREST PRODUCTS WHAT TO DO. UNLOCKED AND COPY NOT ALLOWED WITH THE WRITTEN.	GENEL TOLERANS : PROFİL BOY TOLERANSI :	MATERIAL MM MDF	TARİH / DATE 10.10.2018

25 mm Profiles

PROFİLSE - SİLAS ORMAN ÜRÜNLERİ

KAĞIT ÜZERİNDEN ÖLÇÜ ALMAYINIZ !!!

Don't measurate on paper.

ÜRÜN KODU : 25*34

(Product Code)

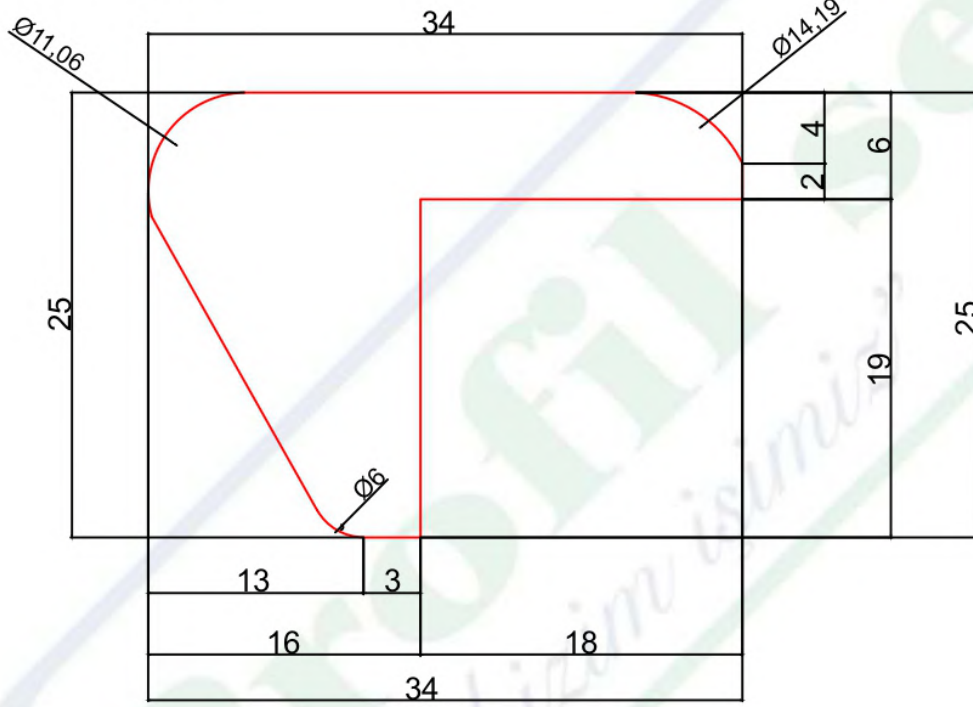

BÖLÜM SORUMLUSU NEJDET ALTINTOPRAK	BU ÇİZİM PROFİLSE - SİLAS ORMAN ÜRÜNLERİ'NE AİTTİR. İZINSİZ ÇOĞALTILMAMAK VE KOPYA EDİLMEKEMEK ŞARTI İLE İZİN VERİLMİŞTİR.	PVC ENİ : MDF MİKTARI : PLAKADAN ÇIKAN :	KSM ÖLÇÜCÜ :	KUTU İÇİ : KUTU İÇİ ADET :
ARGE SORUMLUSU DOĞUKAN DEMİR	THIS DRAWING PROFILE - SİLAS FOREST PRODUCTS WHAT TO DO. UNLOCKED AND COPY NOT ALLOWED WITH THE WRITTEN.	GENEL TOLERANS : PROFİL BOY TOLERANSI :	MATERIAL MM MDF	TARİH / DATE 25.12.2018

25 mm Profiles

PROFİLSE - SİLAS ORMAN ÜRÜNLERİ

KAĞIT ÜZERİNDEN ÖLÇÜ ALMAYINIZ !!!
Don't measure on paper.

ÜRÜN KODU : 25*35-02
(Product Code)

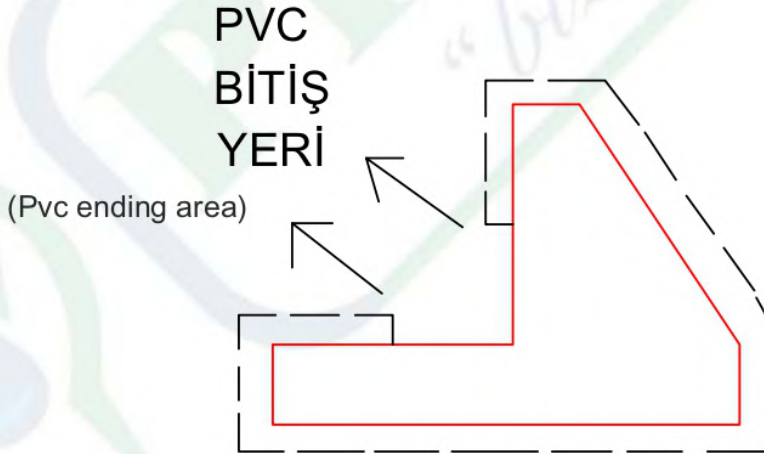
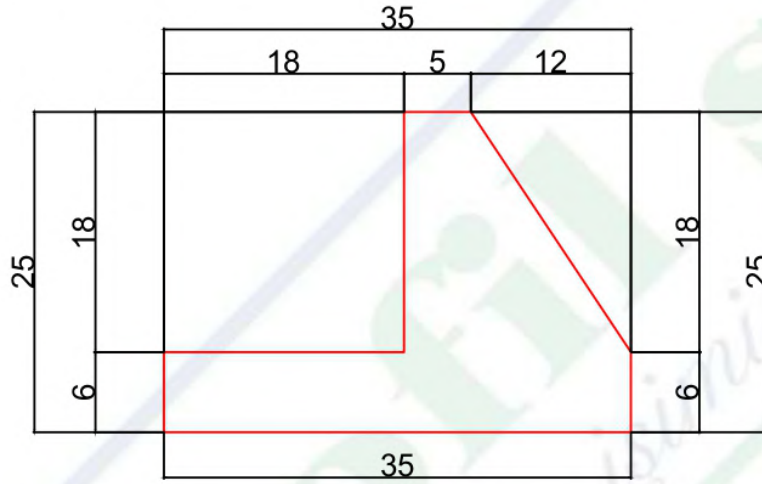

BÖLÜM SORUMLUSU NEJDET ALTINTOPRAK	BU ÇİZİM PROFİLSE - SİLAS ORMAN ÜRÜNLERİ'NE AİTTİR. İZINSİZ ÇOĞALTILMAMAK VE KOPYA EDİLMEKEMEK ŞARTI İLE İZİN VERİLMİŞTİR.	PVC ENİ : MDF MİKTARI : PLAKADAN ÇIKAN :	KSM ÖLÇÜCÜ :	KUTU İÇİ : KUTU İÇİ ADET :
ARGE SORUMLUSU DOĞUKAN DEMİR	THIS DRAWING PROFILE - SİLAS FOREST PRODUCTS WHAT TO DO. UNLOCKED AND COPY NOT ALLOWED WITH THE WRITTEN.	GENEL TOLERANS : PROFİL BOY TOLERANSI :	MATERIAL MM MDF	TARİH / DATE 07.02.2019

25 mm Profiles

PROFİLSE - SİLAS ORMAN ÜRÜNLERİ

KAĞIT ÜZERİNDEN ÖLÇÜ ALMAYINIZ !!!

Don't measurate on paper.

ÜRÜN KODU : 25*74

(Product Code)

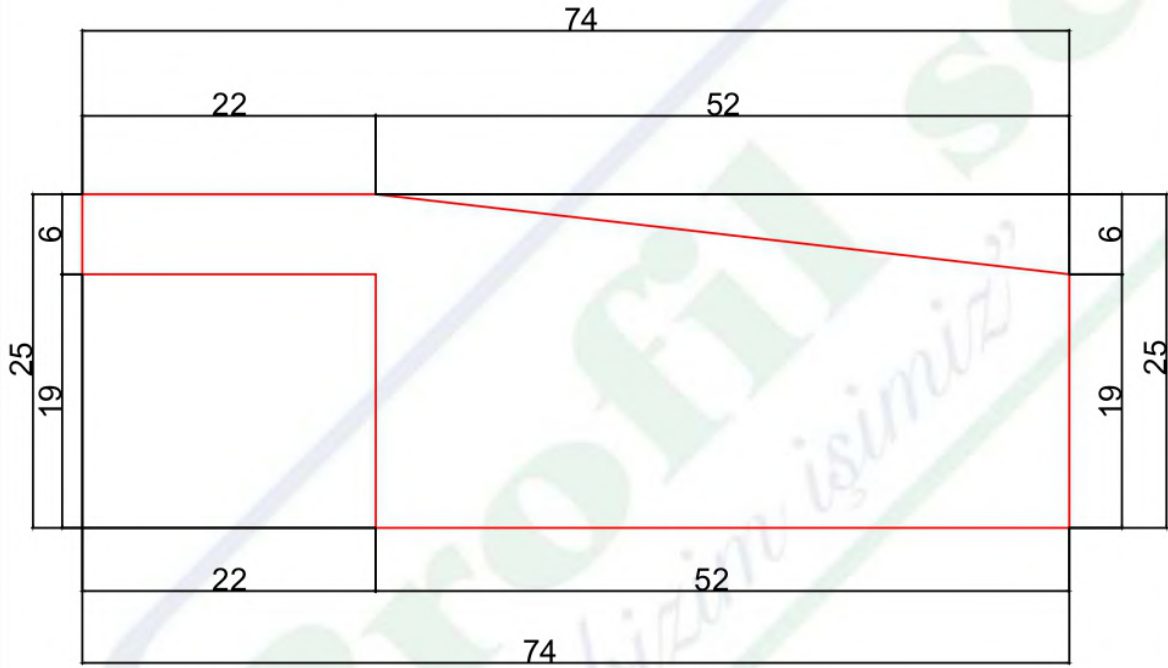

→ PVC BİTİŞ YERİ ←
(Pvc ending area)

BÖLÜM SORUMLUSU NEJDET ALTINTOPRAK	BU ÇİZİM PROFİLSE - SİLAS ORMAN ÜRÜNLERİ'NE AİTTİR. İZINSİZ ÇOĞALTILMAMAK VE KOPYA EDİLMEMEK ŞARTI İLE İZİN VERİLMİŞTİR.	PVC ENİ : MDF MİKTARI : PLAKADAN ÇIKAN :	KSM ÖLÇÜCÜ :	KUTU İÇİ : KUTU İÇİ ADET :
ARGE SORUMLUSU DOĞUKAN DEMİR	THIS DRAWING PROFILE - SİLAS FOREST PRODUCTS WHAT TO DO. UNLOCKED AND COPY NOT ALLOWED WITH THE WRITTEN.	GENEL TOLERANS : PROFİL BOY TOLERANSI :	MATERİYAL MM MDF	TARİH / DATE 26.11.2018

25 mm Profiles

PROFİLSE - SİLAS ORMAN ÜRÜNLERİ

KAĞIT ÜZERİNDEN ÖLÇÜ ALMAYINIZ !!!
Don't measure on paper.

ÜRÜN KODU : 25*25
(Product Code)

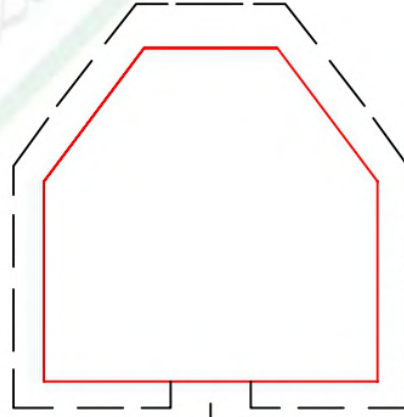
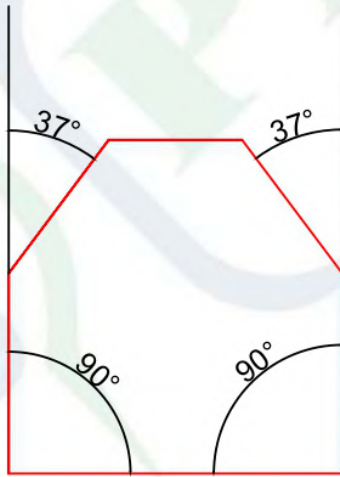
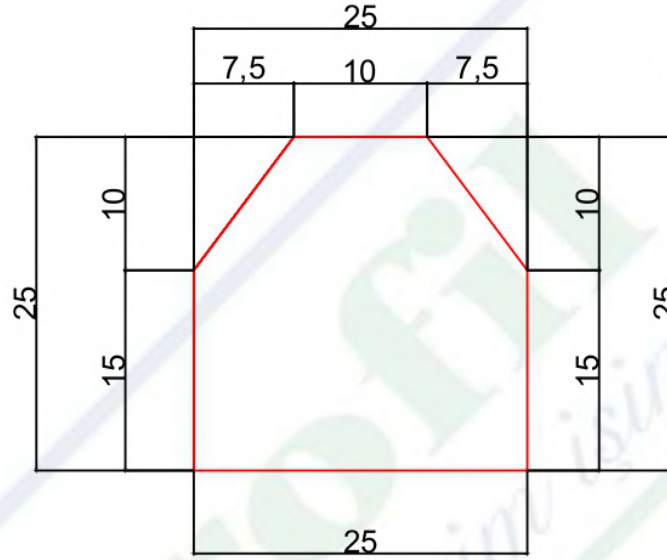

PVC BİTİŞ YERİ
(Pvc ending area)

BÖLÜM SORUMLUSU NEJDET ALTINTOPRAK	BU ÇİZİM PROFİLSE - SİLAS ORMAN ÜRÜNLERİ'NE AİTTİR. İZINSİZ ÇOĞALTILMAMAK VE KOPYA EDİLMEKEMEK ŞARTI İLE İZİN VERİLMİŞTİR.	PVC ENİ : MDF MİKTARI : PLAKADAN ÇIKAN :	KSM ÖLÇÜCÜ :	KUTU İÇİ : KUTU İÇİ ADET :
ARGE SORUMLUSU DOĞUKAN DEMİR	THIS DRAWING PROFILE - SİLAS FOREST PRODUCTS WHAT TO DO. UNLOCKED AND COPY NOT ALLOWED WITH THE WRITTEN.	GENEL TOLERANS : PROFİL BOY TOLERANSI :	MATERİYAL : MM MDF	TARİH / DATE 21.01.2019

25 mm Profiles

PROFİLSE - SİLAS ORMAN ÜRÜNLERİ

KAĞIT ÜZERİNDEN ÖLÇÜ ALMAYINIZ !!!

ÜRÜN KODU : 25*56
(Product Code)

Don't measurate on paper.

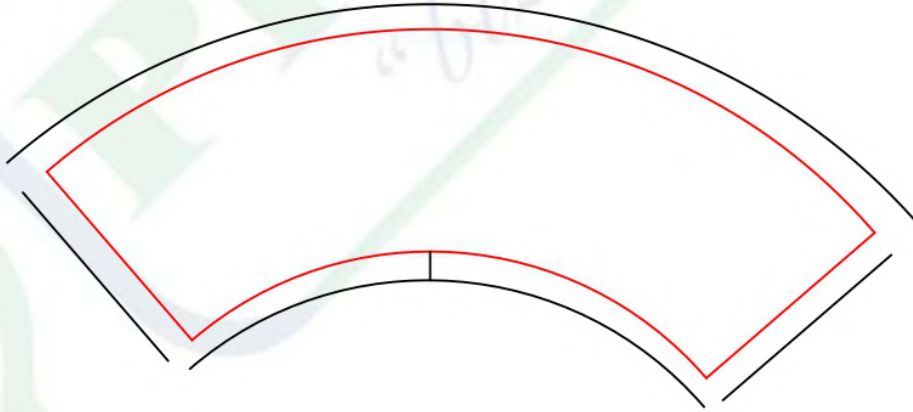
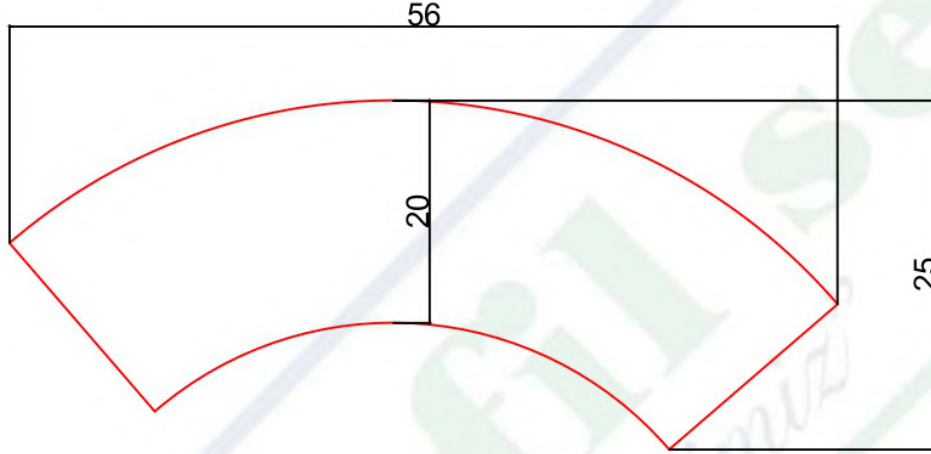

BÖLÜM SORUMLUSU NEJDET ALTINTOPRAK	BU ÇİZİM PROFİLSE - SİLAS ORMAN ÜRÜNLERİ'NE AİTTİR. İZINSİZ ÇOĞALTILMAMAK VE KOPYA EDİLMEMEK ŞARTI İLE İZİN VERİLMİŞTİR.	PVC ENİ : MDF MİKTARI : PLAKADAN ÇIKAN :	KSM ÖLÇÜCÜ :	KUTU İÇİ : KUTU İÇİ ADET :
ARGE SORUMLUSU DOĞUKAN DEMİR	THIS DRAWING PROFILE - SİLAS FOREST PRODUCTS WHAT TO DO. UNLOCKED AND COPY NOT ALLOWED WITH THE WRITTEN.	GENEL TOLERANS : PROFL BOY TOLERANSI :	MATERIAL MM MDF	TARİH / DATE 14.11.2018

25 mm Profiles

PROFİLSE - SİLAS ORMAN ÜRÜNLERİ

KAĞIT ÜZERİNDEN ÖLÇÜ ALMAYINIZ !!!

Don't measurate on paper.

ÜRÜN KODU : 25*47
(Product Code)

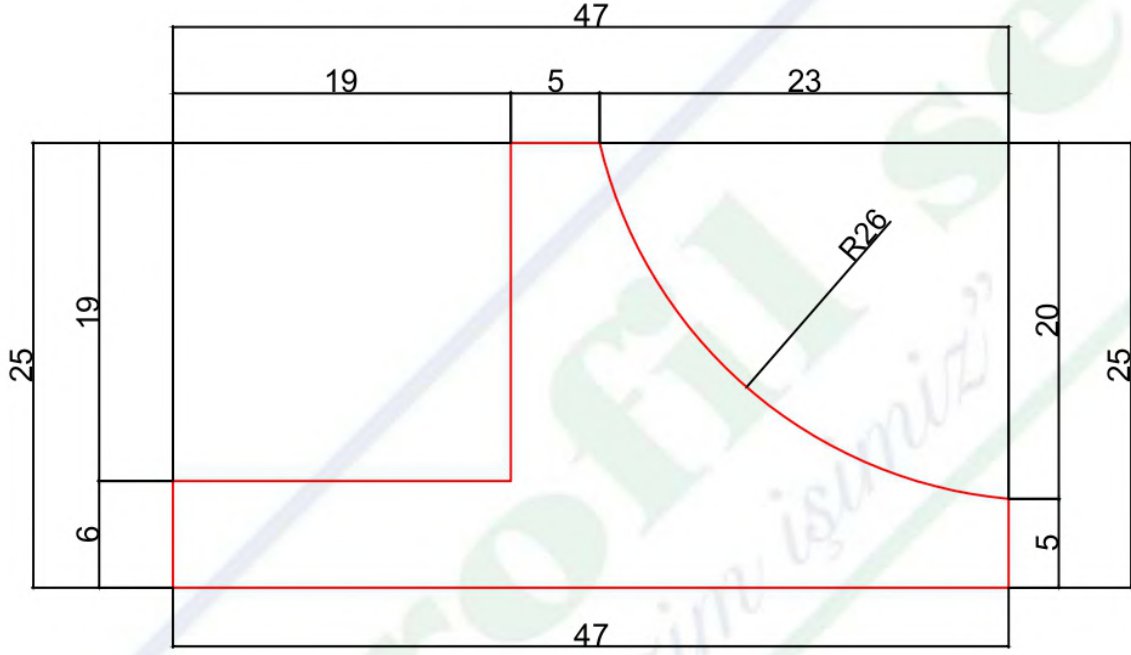

PVC BİTİŞ YERİ
(Pvc ending area)

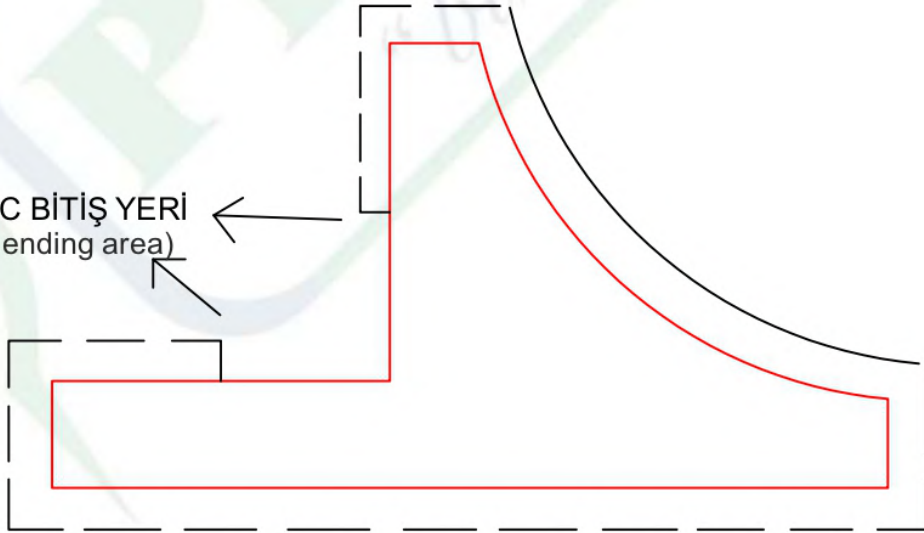

BÖLÜM SORUMLUSU NEJDET ALTINTOPRAK	BU ÇİZİM PROFİLSE - SİLAS ORMAN ÜRÜNLERİ'NE AİTTİR. İZINSİZ ÇOĞALTILMAMAK VE KOPYA EDİLMEKEMEK ŞARTI İLE İZİN VERİLMİŞTİR.	PVC ENİ : MDF MİKTARI : PLAKADAN ÇIKAN :	KSM ÖLÇÜCÜ :	KUTU İÇİ : KUTU İÇİ ADET :
ARGE SORUMLUSU DOĞUKAN DEMİR	THIS DRAWING PROFILE - SİLAS FOREST PRODUCTS WHAT TO DO. UNLOCKED AND COPY NOT ALLOWED WITH THE WRITTEN.	GENEL TOLERANS : PROFİL BOY TOLERANSI :	MATERİYAL MM MDF	TARİH / DATE 17.01.2019

25 mm Profiles

PROFİLSE - SİLAS ORMAN ÜRÜNLERİ

KAĞIT ÜZERİNDEN ÖLÇÜ ALMAYINIZ !!!

Don't measurate on paper.

ÜRÜN KODU : 25*60

(Product Code)

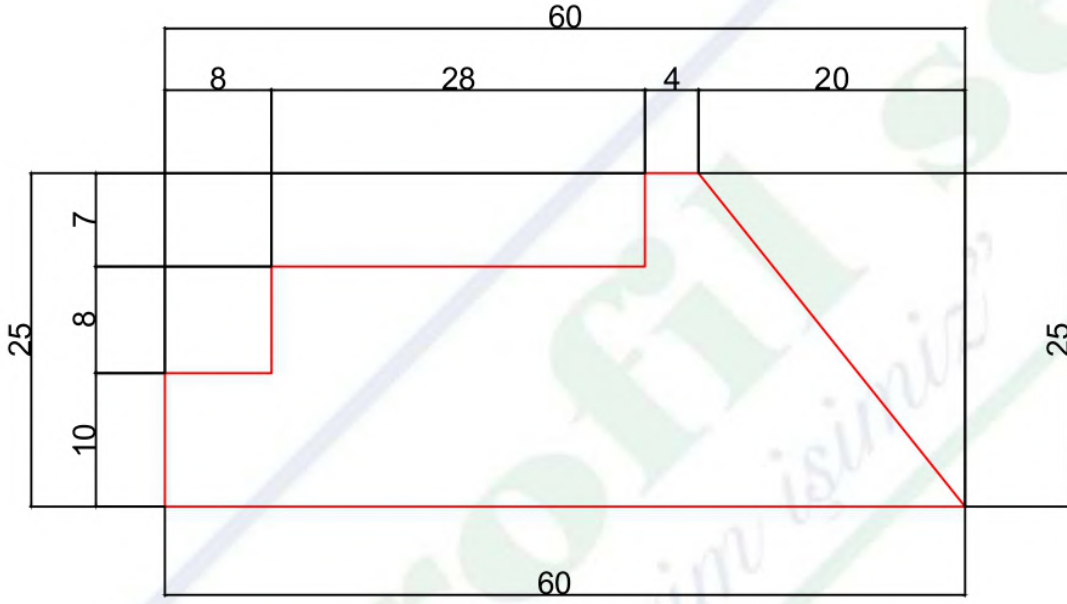

(Pvc ending area)

PVC BİTİŞ YERİ

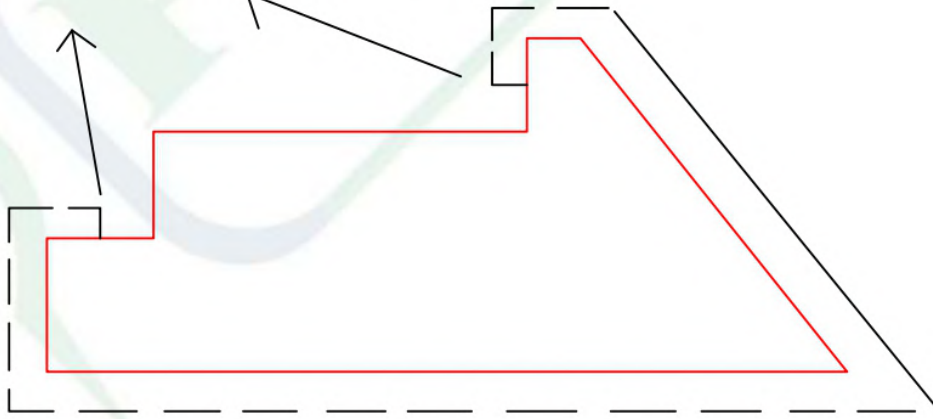

BÖLÜM SORUMLUSU NEJDET ALTINTOPRAK	BU ÇİZİM PROFİLSE - SİLAS ORMAN ÜRÜNLERİ'NE AİTTİR. İZİNSİZ ÇOĞALTILMAMAK VE KOPYA EDİLMEYEN ŞARTI İLE İZİN VERİLMİŞTİR.	PVC ENİ : MDF MİKTARI : PLAKADAN ÇIKAN :	KSM ÖLÇÜCÜ :	KUTU İÇİ : KUTU İÇİ ADET :
ARGE SORUMLUSU DOĞUKAN DEMİR	THIS DRAWING PROFILE - SILAS FOREST PRODUCTS WHAT TO DO. UNLOCKED AND COPY NOT ALLOWED WITH THE WRITTEN.	GENEL TOLERANS : PROFİL BOY TOLERANSI :	MATERİYAL MM MDF	TARİH / DATE 15.11.2018

25 mm Profiles

PROFİLSE - SİLAS ORMAN ÜRÜNLERİ

ÜRÜN KODU : 25*64
(Product Code)

Don't measurate on paper.

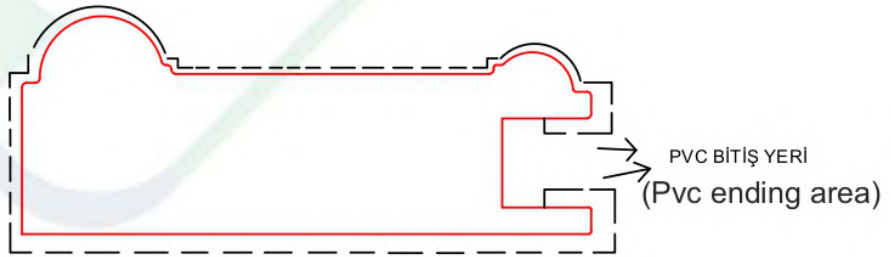
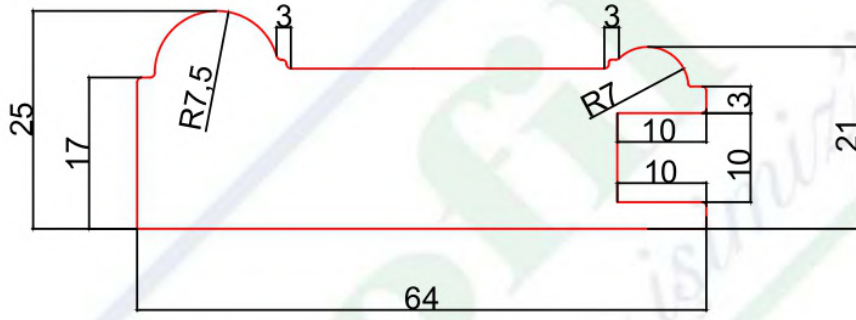

BÖLÜM SORUMLUSU NEJDET ALTINTOPRAK	BU ÇİZİM PROFİLSE - SİLAS ORMAN ÜRÜNLERİ'NE AİTTİR. İZİNSİZ ÇOĞALTILMAMAK VE KOPYA EDİLMEKEMEK ŞARTI İLE İZİN VERİLMİŞTİR.	PVC ENİ : MDF MİKTARI : PLAKADAN ÇIKAN :	KSM ÖLÇÜCÜ :	KUTU İÇİ : KUTU İÇİ ADET :
ARGE SORUMLUSU DOĞUKAN DEMİR	THIS DRAWING PROFILE - SİLAS FOREST PRODUCTS WHAT TO DO. UNLOCKED AND COPY NOT ALLOWED WITH THE WRITTEN.	GENEL TOLERANS : PROFİL BOY TOLERANSI :	MATERİYAL MM MDF	TARİH / DATE 04.10.2018

25 mm Profiles

PROFİLSE - SİLAS ORMAN ÜRÜNLERİ

KAĞIT ÜZERİNDEN ÖLÇÜ ALMAYINIZ !!!
Don't measure on paper.

ÜRÜN KODU : 25*30
(Product Code)

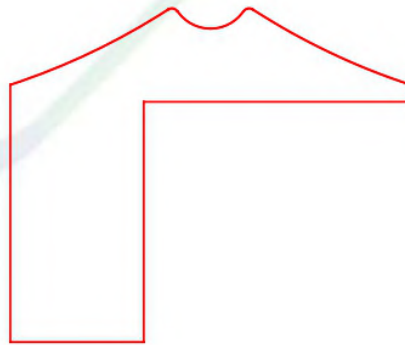
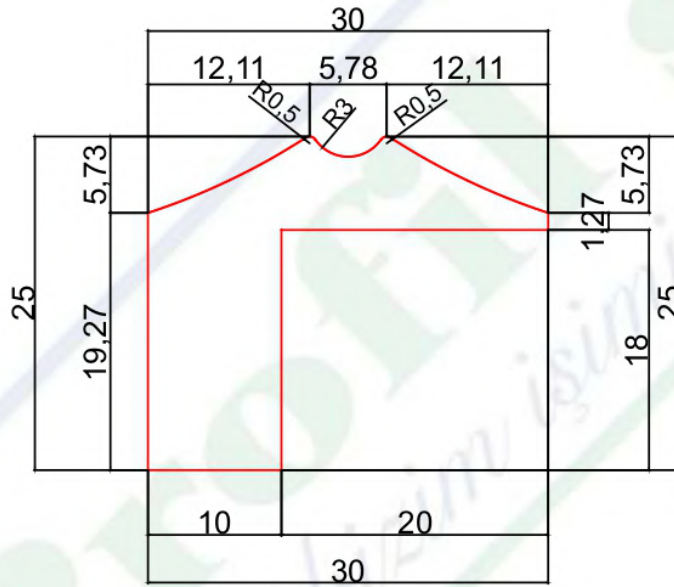

BÖLÜM SORUMLUSU NEJDET ALTINTOPRAK	BU ÇİZİM PROFİLSE - SİLAS ORMAN ÜRÜNLERİ'NE AİTTİR. İZİNSİZ ÇOĞALTILMAMAK VE KOPYA EDİLMEMEK ŞARTI İLE İZİN VERİLMİŞTİR.	PVC ENİ : MDF MİKTARI : PLAKADAN ÇIKAN :	KSM ÖLÇÜCÜ :	KUTU İÇİ : KUTU İÇİ ADET :
ARGE SORUMLUSU DOĞUKAN DEMİR	THIS DRAWING PROFILE - SİLAS FOREST PRODUCTS WHAT TO DO. UNLOCKED AND COPY NOT ALLOWED WITH THE WRITTEN.	GENEL TOLERANS : PROFİL BOY TOLERANSI :	MATERİYAL MM MDF	TARİH / DATE 3.01.2019

25 mm Profiles

PROFİLSE - SİLAS ORMAN ÜRÜNLERİ

KAĞIT ÜZERİNDEN ÖLÇÜ ALMAYINIZ !!!

Don't measurate on paper.

ÜRÜN KODU : 25*30

(Product Code)

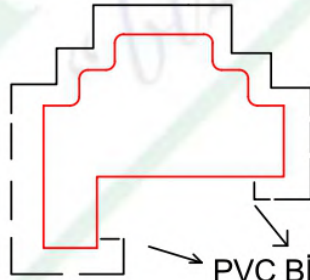
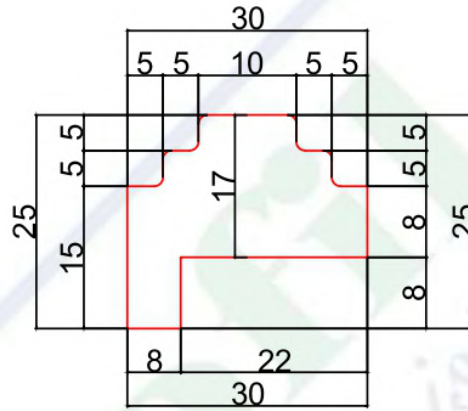

PVC BİTİŞ YERİ

(Pvc ending area)

BÖLÜM SORUMLUSU NEJDET ALTINTOPRAK	BU ÇİZİM PROFİLSE - SİLAS ORMAN ÜRÜNLERİ'NE AİTTİR. İZINSİZ ÇOĞALTILMAMAK VE KOPYA EDİLMEKEMEK ŞARTI İLE İZİN VERİLMİŞTİR.	PVC ENİ : MDF MİKTARI : PLAKADAN ÇIKAN :	KSM ÖLÇÜCÜ :	KUTU İÇİ : KUTU İÇİ ADET :
ARGE SORUMLUSU DOĞUKAN DEMİR	THIS DRAWING PROFILE - SİLAS FOREST PRODUCTS WHAT TO DO. UNLOCKED AND COPY NOT ALLOWED WITH THE WRITTEN.	GENEL TOLERANS : PROFİL BOY TOLERANSI :	MATERIAL MM MDF	TARİH / DATE 04.10.2018

25 mm Profiles

PROFİLSE - SİLAS ORMAN ÜRÜNLERİ

KAĞIT ÜZERİNDEN ÖLÇÜ ALMAYINIZ !!!
Don't measure on paper.

(Product Code)

ÜRÜN KODU : 25*75

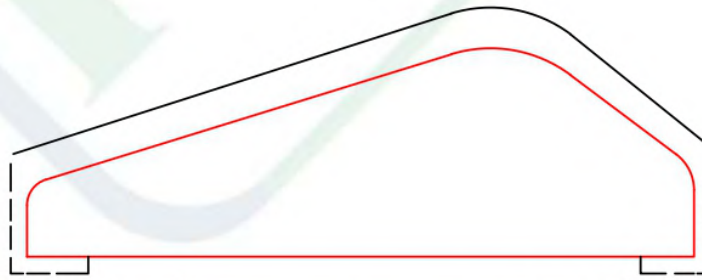
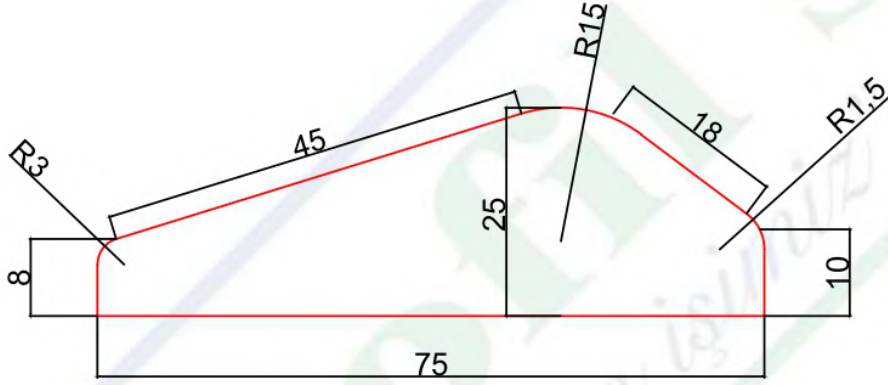

PVC BİTİŞ YERİ

(Pvc ending area)

BÖLÜM SORUMLUSU NEJDET ALTINTOPRAK	BU ÇİZİM PROFİLSE - SİLAS ORMAN ÜRÜNLERİ'NE AİTTİR. İZINSİZ ÇOĞALTILMAMAK VE KOPYA EDİLMEMEK ŞARTI İLE İZİN VERİLMİŞTİR.	PVC ENİ : MDF MİKTARI : PLAKADAN ÇIKAN :	KSM ÖLÇÜCÜ :	KUTU İÇİ : KUTU İÇİ ADET :
ARGE SORUMLUSU DOĞUKAN DEMİR	THIS DRAWING PROFILE - SİLAS FOREST PRODUCTS WHAT TO DO. UNLOCKED AND COPY NOT ALLOWED WITH THE WRITTEN.	GENEL TOLERANS : PROFİL BOY TOLERANSI :	MATERİYAL MM MDF	TARİH / DATE 04.12.2018

25 mm Profiles

PROFİLSE - SİLAS ORMAN ÜRÜNLERİ

KAĞIT ÜZERİNDEN ÖLÇÜ ALMAYINIZ !!!

Don't measure on paper.

ÜRÜN KODU : 25*80

(Product Code)

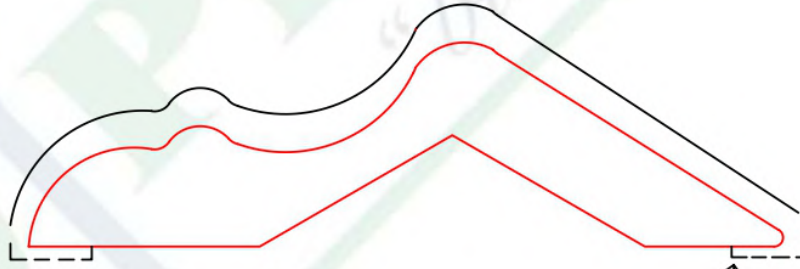
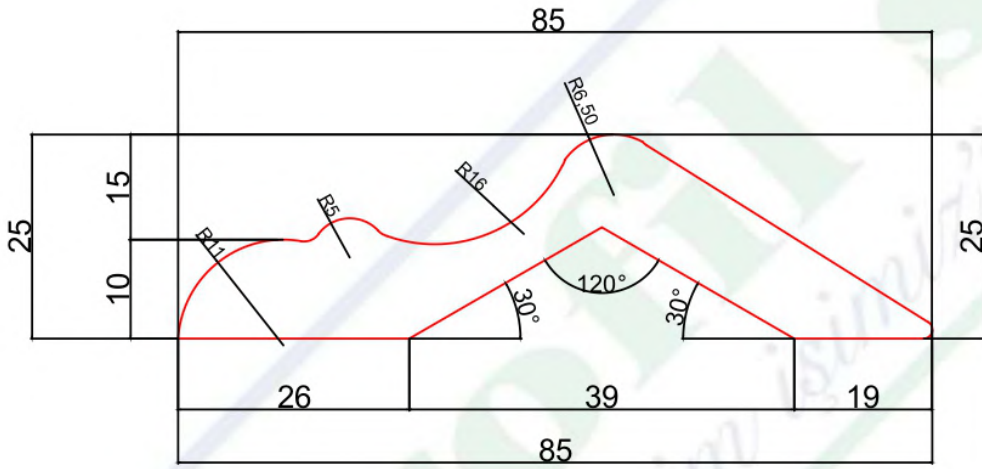

PVC BİTİŞ YERİ

(Pvc ending area)

BÖLÜM SORUMLUSU NEJDET ALTINTOPRAK	BU ÇİZİM PROFİLSE - SİLAS ORMAN ÜRÜNLERİ'NE AİTTİR. İZINSİZ ÇOĞALTILMAMAK VE KOPYA EDİLMEK ŞARTI İLE İZİN VERİLMİŞTİR.	PVC ENİ : MDF MİKTARI : PLAKADAN ÇIKAN :	KSM ÖLÇÜCÜ :	KUTU İÇİ : KUTU İÇİ ADET :
ARGE SORUMLUSU DOĞUKAN DEMİR	THIS DRAWING PROFILE - SİLAS FOREST PRODUCTS WHAT TO DO. UNLOCKED AND COPY NOT ALLOWED WITH THE WRITTEN.	GENEL TOLERANS : PROFİL BOY TOLERANSI :	MATERİYAL MM MDF	TARİH / DATE 21.11.2018

25 mm Profiles

PROFİLSE - SİLAS ORMAN ÜRÜNLERİ

KAĞIT ÜZERİNDEN ÖLÇÜ ALMAYINIZ !!!
Don't measure on paper.

ÜRÜN KODU : 25*35-02

(Product Code)

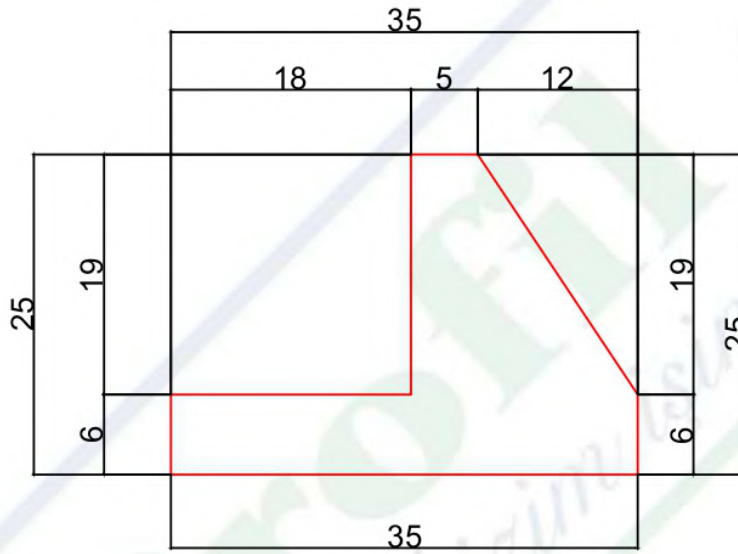

(Pvc ending area)

PVC BİTİŞ YERİ

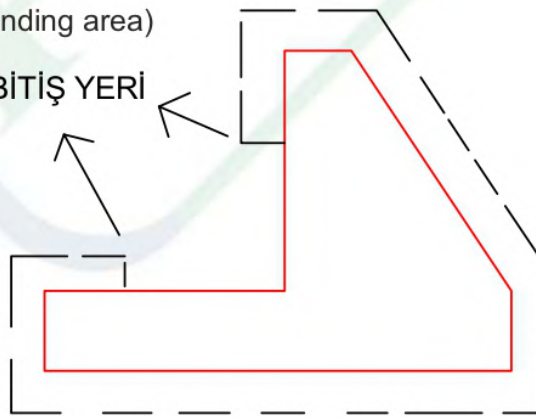

BÖLÜM SORUMLUSU NEJDET ALTINTOPRAK	BU ÇİZİM PROFİLSE - SİLAS ORMAN ÜRÜNLERİ'NE AİTTİR. İZINSİZ ÇOĞALTILMAMAK VE KOPYA EDİLMEMEK ŞARTI İLE İZİN VERİLMİŞTİR.	PVC ENİ : MDF MİKTARI : PLAKADAN ÇIKAN :	KSM ÖLÇÜCÜ :	KUTU İÇİ : KUTU İÇİ ADET :
ARGE SORUMLUSU DOĞUKAN DEMİR	THIS DRAWING PROFILE - SİLAS FOREST PRODUCTS WHAT TO DO. UNLOCKED AND COPY NOT ALLOWED WITH THE WRITTEN.	GENEL TOLERANS : PROFİL BOY TOLERANSI :	MATERİYAL MM MDF	TARİH / DATE 30.01.2019

25 mm Profiles

PROFİLSE - SİLAS ORMAN ÜRÜNLERİ

ÜRÜN KODU : 25*44
(Product Code)

KAĞIT ÜZERİNDEN ÖLÇÜ ALMAYINIZ !!!
Don't measure on paper.

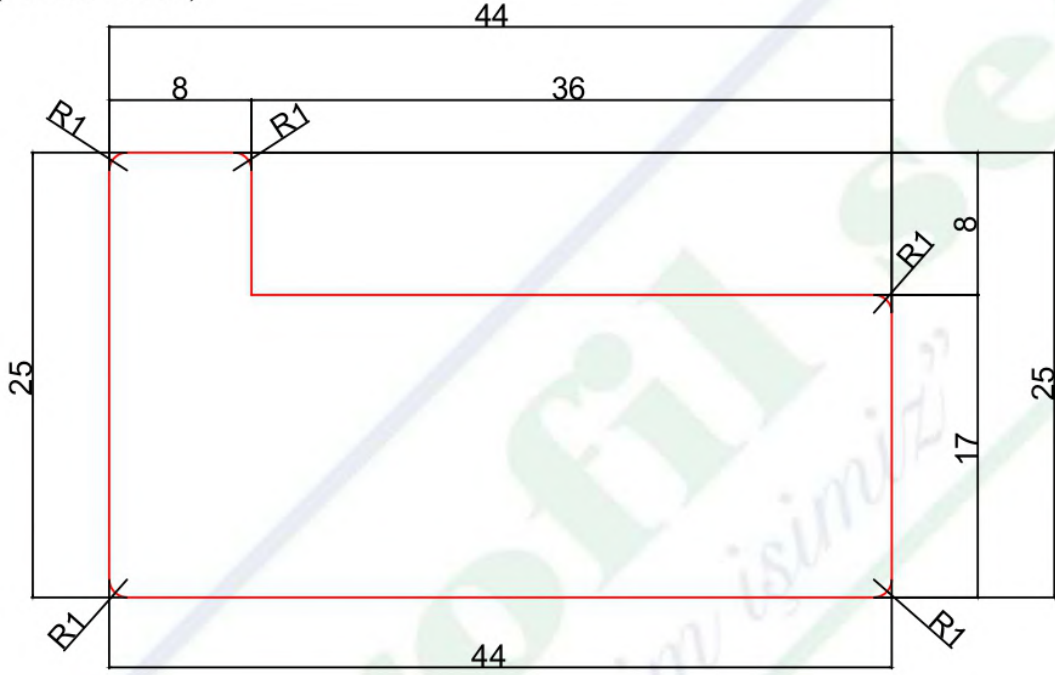

(Pvc ending area)

PVC BİTİŞ YERİ

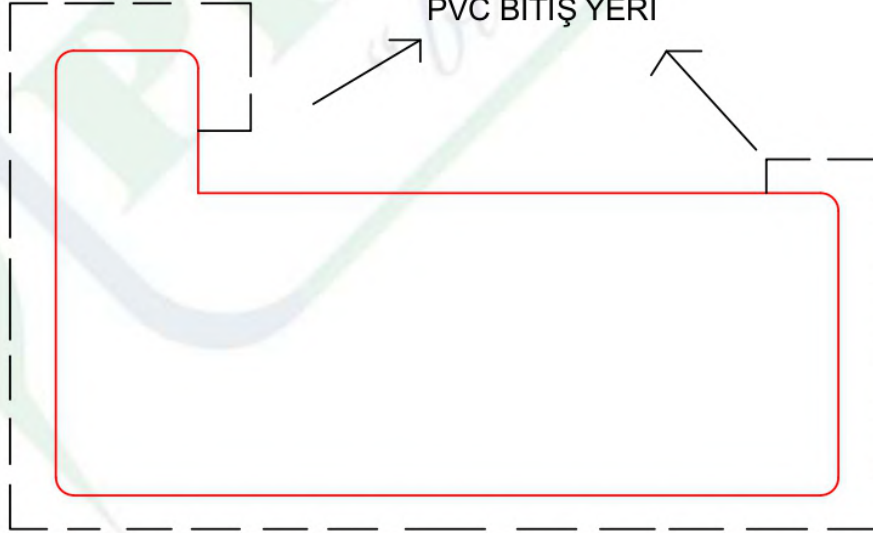

BÖLÜM SORUMLUSU NEJDET ALTINTOPRAK	BU ÇİZİM PROFİLSE - SİLAS ORMAN ÜRÜNLERİ'NE AİTTİR. İZINSİZ ÇOĞALTILMAMAK VE KOPYA EDİLMEMEK ŞARTI İLE İZİN VERİLMİŞTİR.	PVC ENİ : MDF MİKTARI : PLAKADAN ÇIKAN :	KSM ÖLÇÜCÜ :	KUTU İÇİ : KUTU İÇİ ADET :
ARGE SORUMLUSU DOĞUKAN DEMİR	THIS DRAWING PROFILE - SILAS FOREST PRODUCTS WHAT TO DO. UNLOCKED AND COPY NOT ALLOWED WITH THE WRITTEN.	GENEL TOLERANS : PROFL BOY TOLERANSI :	MATERIAL MM MDF	TARİH / DATE 04.12.2018

25 mm Profiles

PROFİLSE - SİLAS ORMAN ÜRÜNLERİ

KAĞIT ÜZERİNDEN ÖLÇÜ ALMAYINIZ !!!

ÜRÜN KODU : 25*25
(Product Code)

Don't measurate on paper.

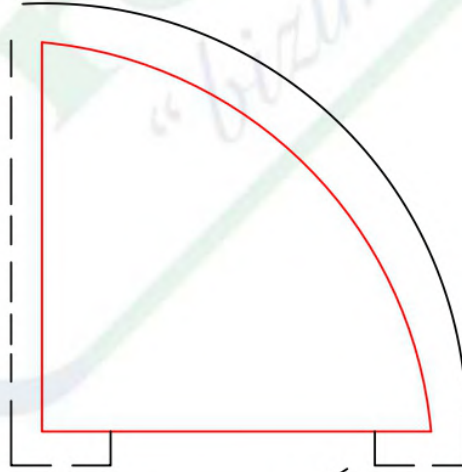
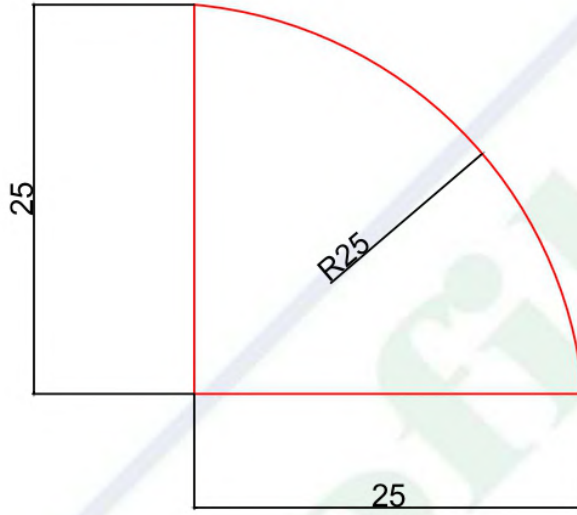

PVC BİTİŞ YERİ
(Pvc ending area)

BÖLÜM SORUMLUSU NEJDET ALTINTOPRAK	BU ÇİZİM PROFİLSE - SİLAS ORMAN ÜRÜNLERİ'NE AİTTİR. İZINSİZ ÇOĞALTILMAMAK VE KOPYA EDİLMEMEK ŞARTI İLE İZİN VERİLMİŞTİR.	PVC ENİ : MDF MİKTARI : PLAKADAN ÇIKAN :	KSM ÖLÇÜCÜ :	KUTU İÇİ : KUTU İÇİ ADET :
ARGE SORUMLUSU DOĞUKAN DEMİR	THIS DRAWING PROFILE - SİLAS FOREST PRODUCTS WHAT TO DO. UNLOCKED AND COPY NOT ALLOWED WITH THE WRITTEN.	GENEL TOLERANS : PROFL BOY TOLERANSI :	MATERİYAL MM MDF	TARİH / DATE 10.10.2018

25 mm Profiles

PROFİLSE - SİLAS ORMAN ÜRÜNLERİ

ÜRÜN KODU : 25*60

(Product Code)

KAĞIT ÜZERİNDEN ÖLÇÜ ALMAYINIZ !!!

Don't measurate on paper.

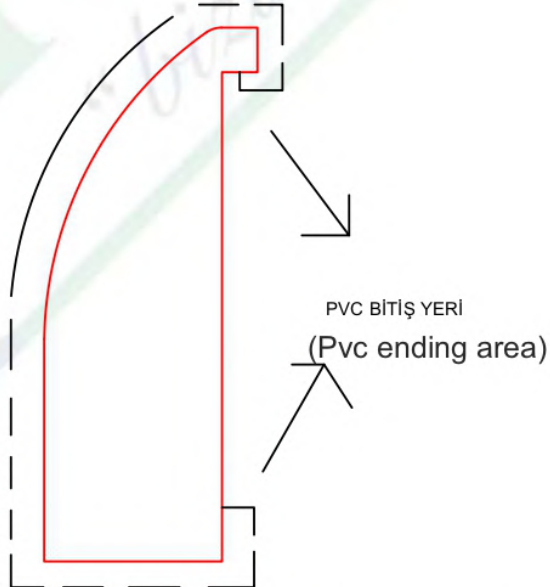
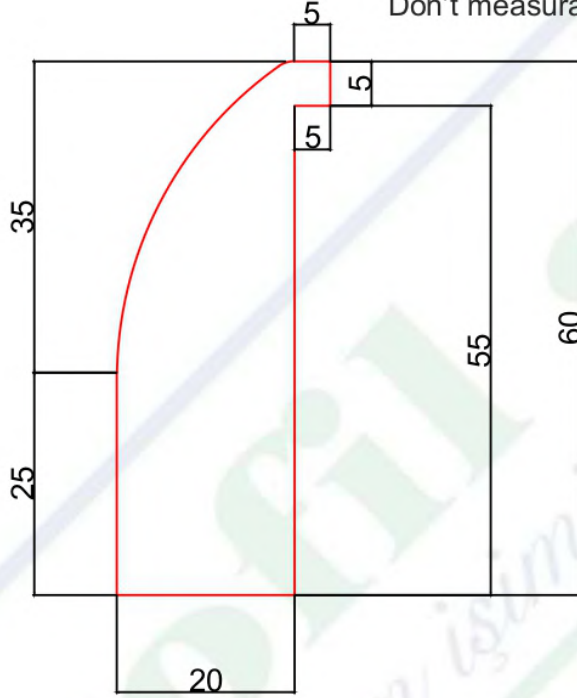

BÖLÜM SORUMLUSU NEJDET ALTINTOPRAK	BU ÇİZİM PROFİLSE - SİLAS ORMAN ÜRÜNLERİ'NE AİTTİR. İZİNSİZ ÇOĞALTILMAMAK VE KOPYA EDİLMEMEK ŞARTI İLE İZİN VERİLMİŞTİR.	PVC ENİ : MDF MİKTARI : PLAKADAN ÇIKAN :	KSM ÖLÇÜCÜ :	KUTU İÇİ : KUTU İÇİ ADET :
ARGE SORUMLUSU DOĞUKAN DEMİR	THIS DRAWING PROFILE - SİLAS FOREST PRODUCTS WHAT TO DO. UNLOCKED AND COPY NOT ALLOWED WITH THE WRITTEN.	GENEL TOLERANS : PROFİL BOY TOLERANSI :	MATERİYAL MM MDF	TARİH / DATE 04.10.2018

25 mm Profiles

PROFİLSE - SİLAS ORMAN ÜRÜNLERİ

KAĞIT ÜZERİNDEN ÖLÇÜ ALMAYINIZ !!!

Don't measurate on paper.

ÜRÜN KODU : 25*58
(Product Code)

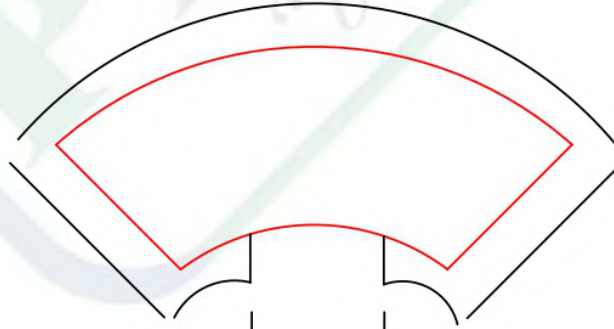
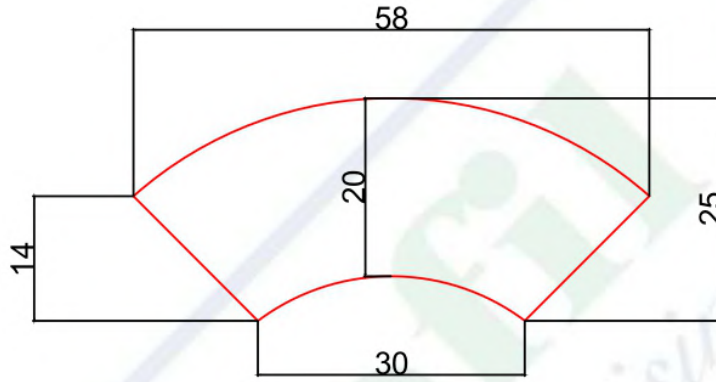

PVC BİTİŞ YERİ

(Pvc ending area)

BÖLÜM SORUMLUSU NEJDET ALTINTOPRAK	BU ÇİZİM PROFİLSE - SİLAS ORMAN ÜRÜNLERİ'NE AİTTİR. İZINSİZ ÇOĞALTILMAMAK VE KOPYA EDİLMEMEK ŞARTI İLE İZİN VERİLMİŞTİR.	PVC ENİ : MDF MİKTARI : PLAKADAN ÇIKAN :	KSM ÖLÇÜCÜ :	KUTU İÇİ : KUTU İÇİ ADET :
ARGE SORUMLUSU DOĞUKAN DEMİR	THIS DRAWING PROFILE - SİLAS FOREST PRODUCTS WHAT TO DO. UNLOCKED AND COPY NOT ALLOWED WITH THE WRITTEN.	GENEL TOLERANS : PROFL BOY TOLERANSI :	MATERİAL MM MDF	TARİH / DATE 18.10.2018

25 mm Profiles

PROFİLSE - SİLAS ORMAN ÜRÜNLERİ

KAĞIT ÜZERİNDEN ÖLÇÜ ALMAYINIZ !!!
Don't measurate on paper.

ÜRÜN KODU : 25*70
(Product Code)

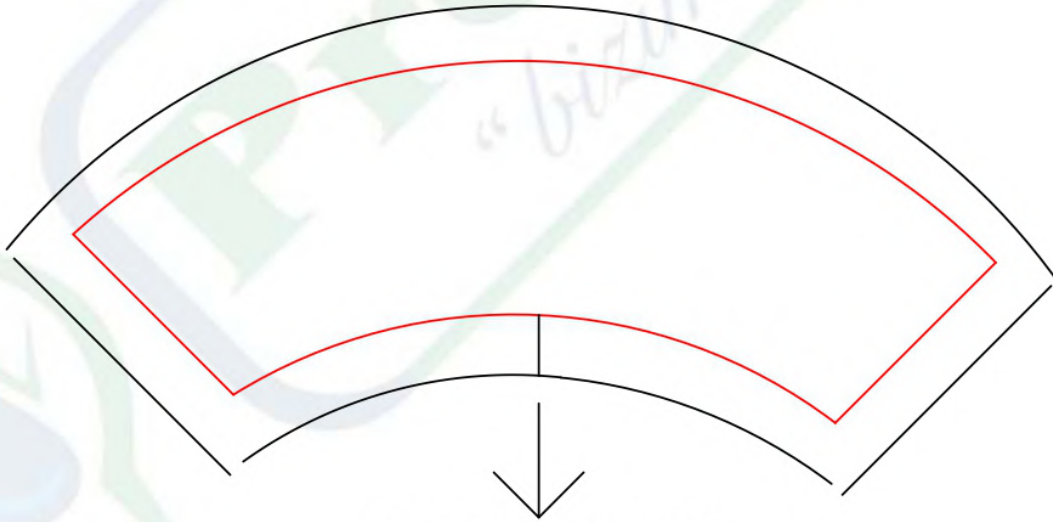
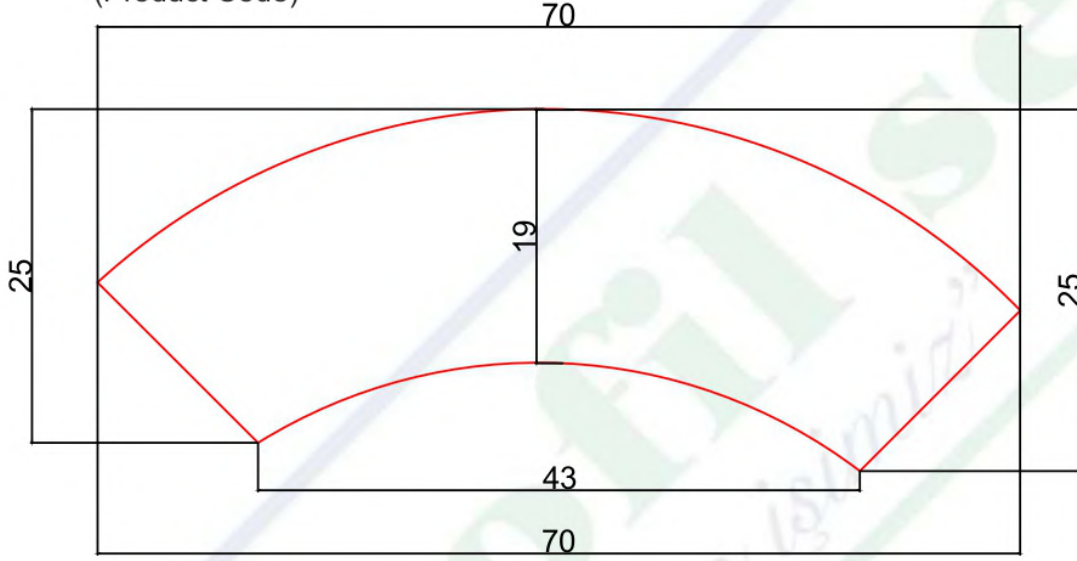

PVC BİTİŞ YERİ
(Pvc ending area)

BÖLÜM SORUMLUSU NEJDET ALTINTOPRAK	BU ÇİZİM PROFİLSE - SİLAS ORMAN ÜRÜNLERİ'NE AİTTİR. İZINSİZ ÇOĞALTILMAMAK VE KOPYA EDİLMEKEMEK ŞARTI İLE İZİN VERİLMİŞTİR.	PVC ENİ : MDF MİKTARI : PLAKADAN ÇIKAN :	KSM ÖLÇÜCÜ :	KUTU İÇİ : KUTU İÇİ ADET :
ARGE SORUMLUSU DOĞUKAN DEMİR	THIS DRAWING PROFILE - SİLAS FOREST PRODUCTS WHAT TO DO. UNLOCKED AND COPY NOT ALLOWED WITH THE WRITTEN.	GENEL TOLERANS : PROFL BOY TOLERANSI :	MATERİAL MM MDF	TARİH / DATE 10.04.2019

25 mm Profiles

PROFİLSE - SİLAS ORMAN ÜRÜNLERİ

KAĞIT ÜZERİNDEN ÖLÇÜ ALMAYINIZ !!!

Don't measurate on paper.

ÜRÜN KODU : 25*50

(Product Code)

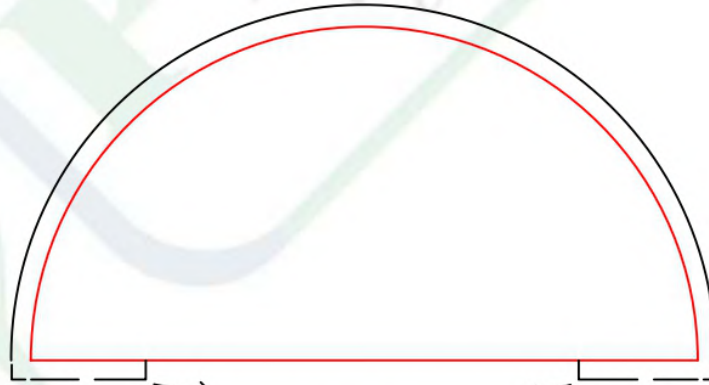
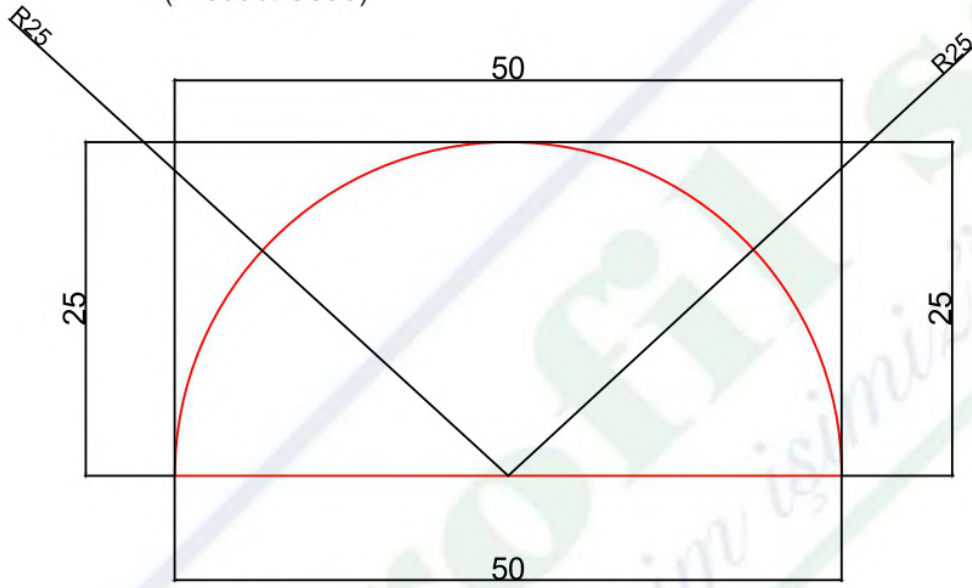

PVC BİTİŞ YERİ
(Pvc ending area)

BÖLÜM SORUMLUSU NEJDET ALTINTOPRAK	BU ÇİZİM PROFİLSE - SİLAS ORMAN ÜRÜNLERİ'NE AİTTİR. İZİNSİZ ÇOĞALTILMAMAK VE KOPYA EDİLMEMEK ŞARTI İLE İZİN VERİLMİŞTİR.	PVC ENİ : MDF MİKTARI : PLAKADAN ÇIKAN :	KSM ÖLÇÜCÜ :	KUTU İÇİ : KUTU İÇİ ADET :
ARGE SORUMLUSU DOĞUKAN DEMİR	THIS DRAWING PROFILE - SİLAS FOREST PRODUCTS WHAT TO DO. UNLOCKED AND COPY NOT ALLOWED WITH THE WRITTEN.	GENEL TOLERANS : PROFİL BOY TOLERANSI :	MATERİYAL MM MDF	TARİH / DATE 03.04.2019

25 mm Profiles

PROFİLSE - SİLAS ORMAN ÜRÜNLERİ

KAĞIT ÜZERİNDEN ÖLÇÜ ALMAYINIZ !!!
Don't measurate on paper.

ÜRÜN KODU : 25*50

(Product Code)

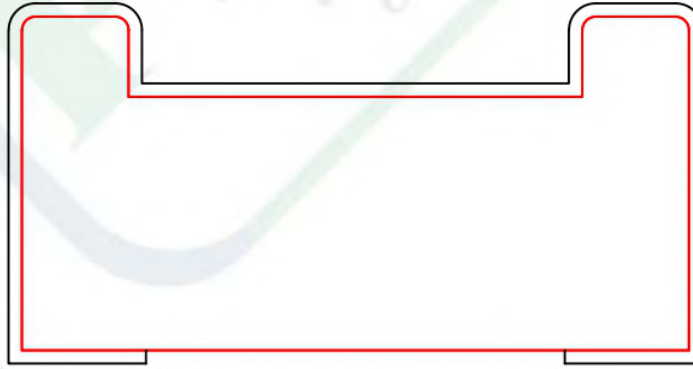
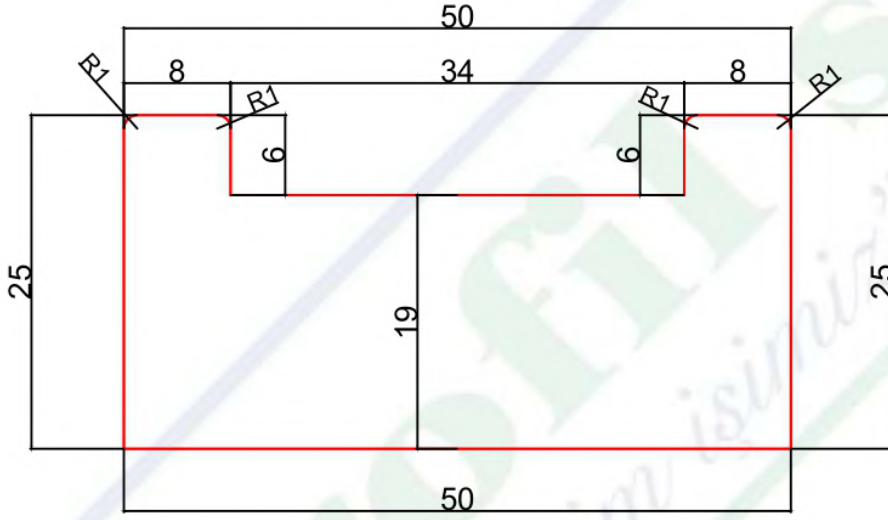

PVC BİTİŞ YERİ
(Pvc ending area)

BÖLÜM SORUMLUSU NEJDET ALTINTOPRAK	BU ÇİZİM PROFİLSE - SİLAS ORMAN ÜRÜNLERİ'NE AİTTİR. İZINSİZ ÇOĞALTILMAMAK VE KOPYA EDİLMEK ŞARTI İLE İZİN VERİLMİŞTİR.	MDF MIKTARI : TABAKADAN ÇIKAN :	PVC ÖLÇÜSÜ :	KUTU İÇİ : KUTU İÇİ ADET :
ARGE SORUMLUSU DOĞUKAN DEMİR	THIS DRAWING PROFILE - SILAS FOREST PRODUCTS WHAT TO DO. UNLOCKED AND COPY NOT ALLOWED WITH THE WRITTEN.	STANDART PROFİL BOY : PROFİL BOY :	MDF TÜRÜ MM MDF	TARİH / DATE 18.04.2019

27-28 mm Profiles

PROFİLSE - SİLAS ORMAN ÜRÜNLERİ

KAĞIT ÜZERİNDEN ÖLÇÜ ALMAYINIZ !!!

ÜRÜN KODU : 27*30

(Product Code)

Don't measurate on paper.

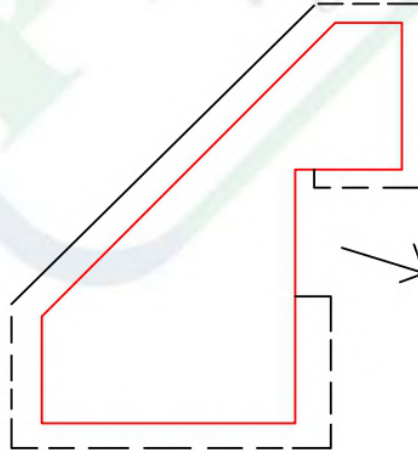
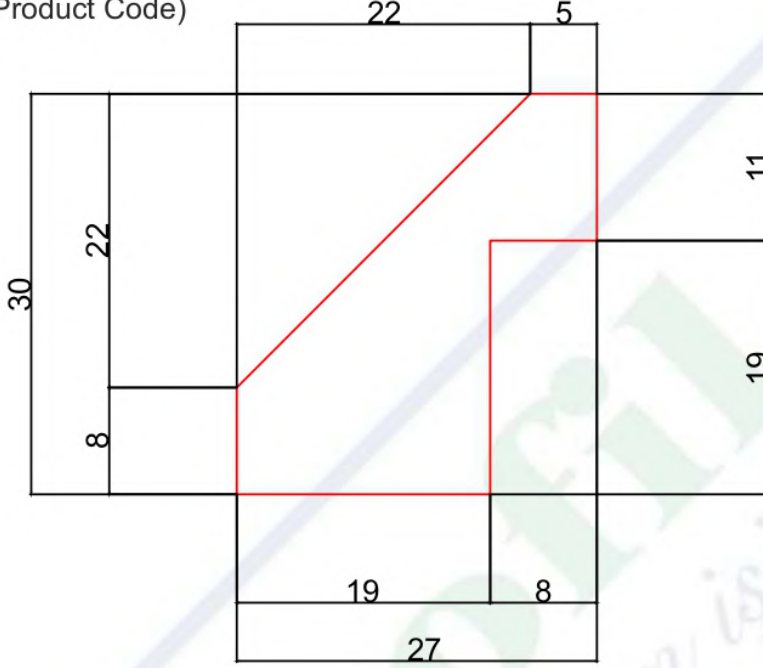

PVC BİTİŞ YERİ
(Pvc ending area)

BÖLÜM SORUMLUSU NEJDET ALTINTOPRAK	BU ÇİZİM PROFİLSE - SİLAS ORMAN ÜRÜNLERİ'NE AİTTİR. İZINSİZ ÇOĞALTILMAMAK VE KOPYA EDİLMEMEK ŞARTI İLE İZİN VERİLMİŞTİR.	PVC ENİ : MDF MİKTARI : PLAKADAN ÇIKAN :	KSM ÖLÇÜCÜ :	KUTU İÇİ : KUTU İÇİ ADET :
ARGE SORUMLUSU DOĞUKAN DEMİR	THIS DRAWING PROFILE - SİLAS FOREST PRODUCTS WHAT TO DO. UNLOCKED AND COPY NOT ALLOWED WITH THE WRITTEN.	GENEL TOLERANS : PROFİL BOY TOLERANSI :	MATERİYAL MM MDF	TARİH / DATE 5.11.2018

27-28 mm Profiles

PROFİLSE - SİLAS ORMAN ÜRÜNLERİ

KAGIT ÜZERİNDEN ÖLÇÜ ALMAYINIZ !!!

ÜRÜN KODU : 27*30

(Product Code)

Don't measurate on paper.

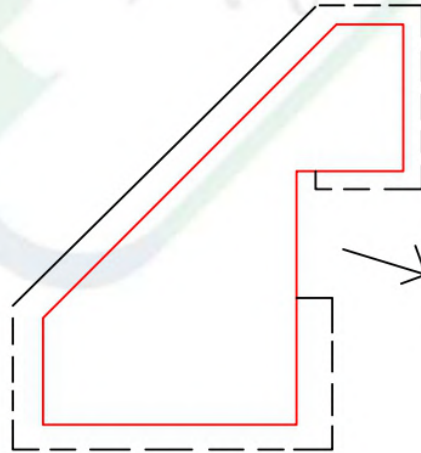
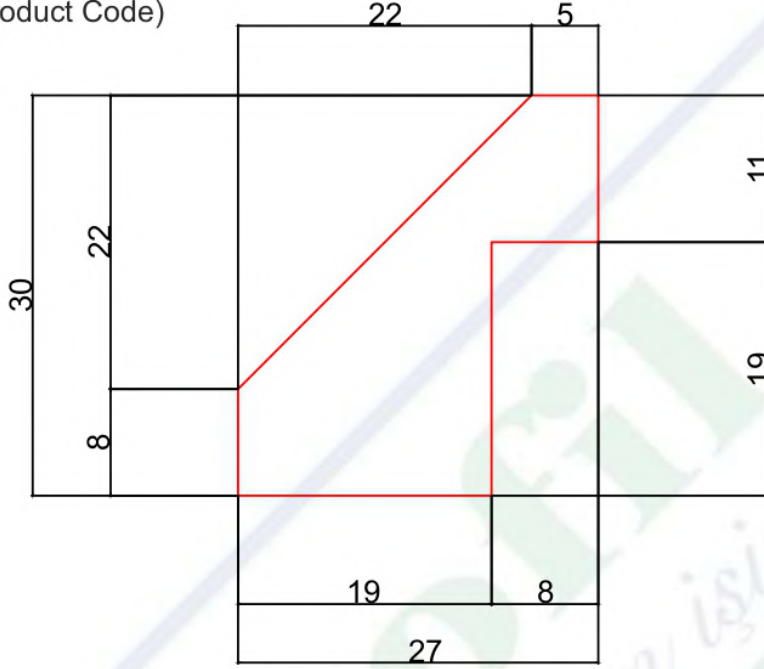

PVC BİTİŞ YERİ
(Pvc ending area)

BÖLÜM SORUMLUSU NEJDET ALTINTOPRAK	BU ÇİZİM PROFİLSE - SİLAS ORMAN ÜRÜNLERİ'NE AİTTİR. İZINSİZ ÇOĞALTILMAMAK VE KOPYA EDİLMEMEK ŞARTI İLE İZİN VERİLMİŞTİR.	PVC ENİ : MDF MİKTARI : PLAKADAN ÇIKAN :	KSM ÖLÇÜCÜ :	KUTU İÇİ : KUTU İÇİ ADET :
ARGE SORUMLUSU DOĞUKAN DEMİR	THIS DRAWING PROFILE - SİLAS FOREST PRODUCTS WHAT TO DO. UNLOCKED AND COPY NOT ALLOWED WITH THE WRITTEN.	GENEL TOLERANS : PROFİL BOY TOLERANSI :	MATERİYAL MM MDF	TARİH / DATE 5.11.2018

27-28 mm Profiles

PROFİLSE - SİLAS ORMAN ÜRÜNLERİ

KAĞIT ÜZERİNDEN ÖLÇÜ ALMAYINIZ !!!

Don't measurate on paper.

ÜRÜN KODU : 27*27

(Product Code)

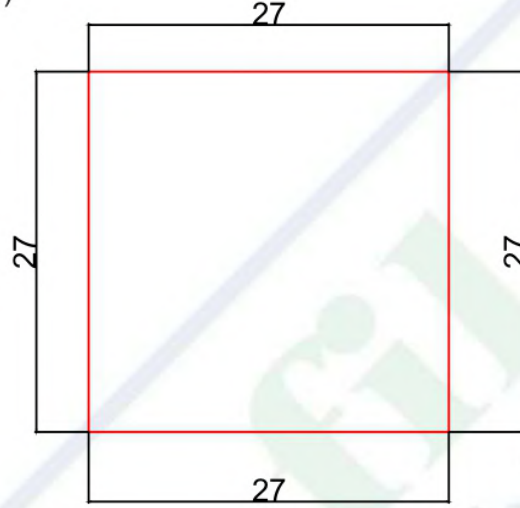

PVC BİTİŞ YERİ

(Pvc ending area)

BÖLÜM SORUMLUSU NEJDET ALTINTOPRAK	BU ÇİZİM PROFİLSE - SİLAS ORMAN ÜRÜNLERİ 'NE AİTTİR. İZİNSİZ ÇOĞALTILMAMAK VE KOPYA EDİLMEMEK ŞARTI İLE İZİN VERİLMİŞTİR.	PVC ENİ : MDF MIKTARI : PLAKADAN ÇIKAN :	KSM ÖLÇÜCÜ :	KUTU İÇİ : KUTU İÇİ ADET :
ARGE SORUMLUSU DOĞUKAN DEMİR	THIS DRAWING PROFILE - SİLAS FOREST PRODUCTS WHAT TO DO. UNLOCKED AND COPY NOT ALLOWED WITH THE WRITTEN.	GENEL TOLERANS : PROFİL BOY TOLERANSI :	MATERIAL MM MDF	TARİH / DATE 04.10.2018

27-28 mm Profiles

PROFİLSE - SİLAS ORMAN ÜRÜNLERİ

KAĞIT ÜZERİNDEN ÖLÇÜ ALMAYINIZ !!!

Don't measurate on paper.

ÜRÜN KODU : 28*30
(Product Code)

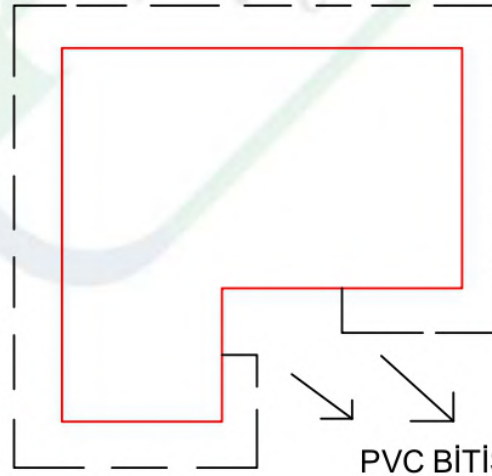
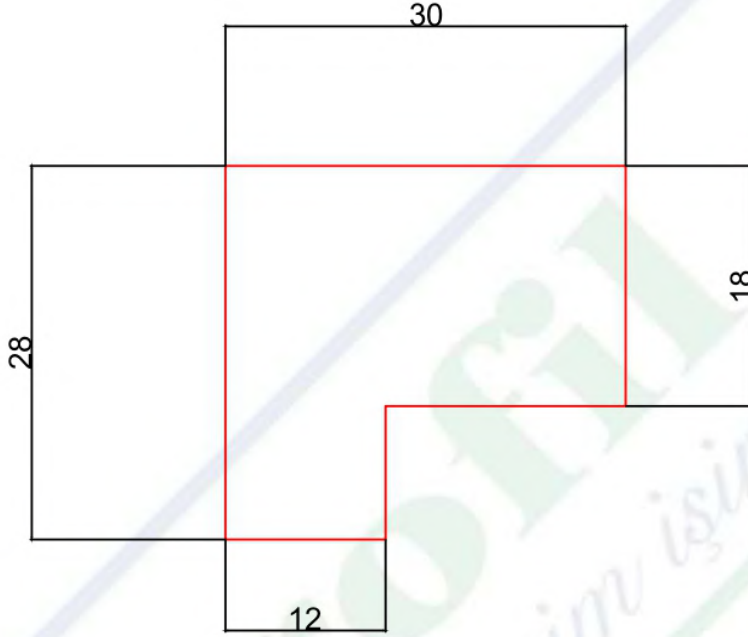

(Pvc ending area)

PVC BITİŞ YERİ

BÖLÜM SORUMLUSU NEJDET ALTINTOPRAK	BU ÇİZİM PROFİLSE - SİLAS ORMAN ÜRÜNLERİ'NE AİTTİR. İZINSİZ ÇOĞALTILMAMAK VE KOPYA EDİLMEMEK ŞARTI İLE İZİN VERİLMİŞTİR.	PVC ENİ : MDF MİKTARI : PLAKADAN ÇIKAN :	KSM ÖLÇÜCÜ :	KUTU İÇİ : KUTU İÇİ ADET :
ARGE SORUMLUSU DOĞUKAN DEMİR	THIS DRAWING PROFILE - SİLAS FOREST PRODUCTS WHAT TO DO. UNLOCKED AND COPY NOT ALLOWED WITH THE WRITTEN.	GENEL TOLERANS : PROFİL BOY TOLERANSI :	MATERIAL MM MDF	TARİH / DATE 10.09.2018

27-28 mm Profiles

PROFİLSE - SİLAS ORMAN ÜRÜNLERİ

ÜRÜN KODU : 28*30
(Product Code)

KAĞIT ÜZERİNDEN ÖLÇÜ ALMAYINIZ !!!
Don't measurate on paper.

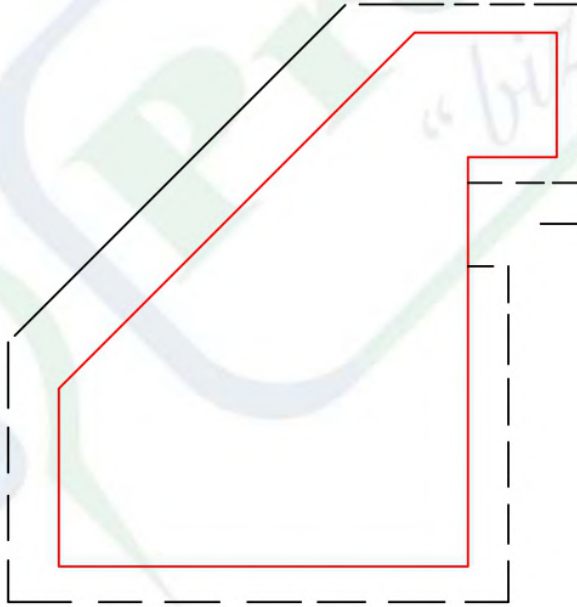
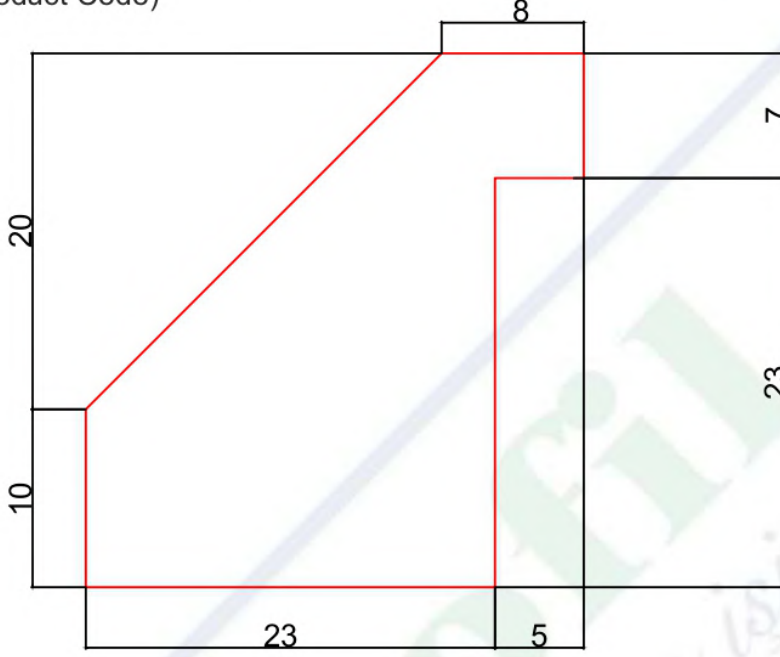

→ PVC BİTİŞ YERİ
(Pvc ending area)

BÖLÜM SORUMLUSU NEJDET ALTINTOPRAK	BU ÇİZİM PROFİLSE - SİLAS ORMAN ÜRÜNLERİ'NE AİTTİR. İZINSİZ ÇOĞALTILMAMAK VE KOPYA EDİLMEKEMEK ŞARTI İLE İZİN VERİLMİŞTİR.	PVC ENİ : MDF MİKTARI : PLAKADAN ÇIKAN :	KSM ÖLÇÜCÜ :	KUTU İÇİ : KUTU İÇİ ADET :
ARGE SORUMLUSU DOĞUKAN DEMİR	THIS DRAWING PROFILE - SİLAS FOREST PRODUCTS WHAT TO DO. UNLOCKED AND COPY NOT ALLOWED WITH THE WRITTEN.	GENEL TOLERANS : PROFİL BOY TOLERANSI :	MATERİYAL MM MDF	TARİH / DATE 18.10.2018

30 mm Profiles

PROFİLSE - SİLAS ORMAN ÜRÜNLERİ

KAĞIT ÜZERİNDEN ÖLÇÜ ALMAYINIZ !!!

Don't measure on paper.

ÜRÜN KODU : 30*50

(Product Code)

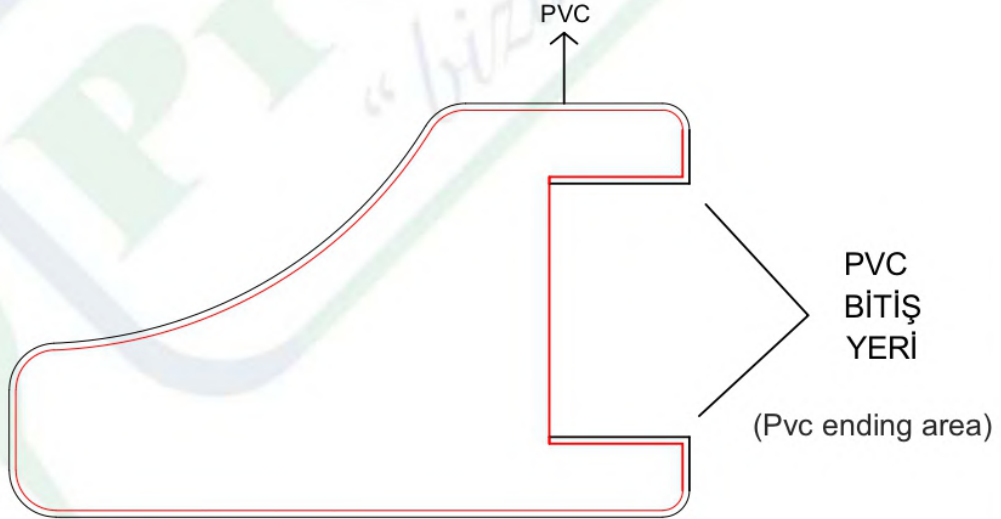
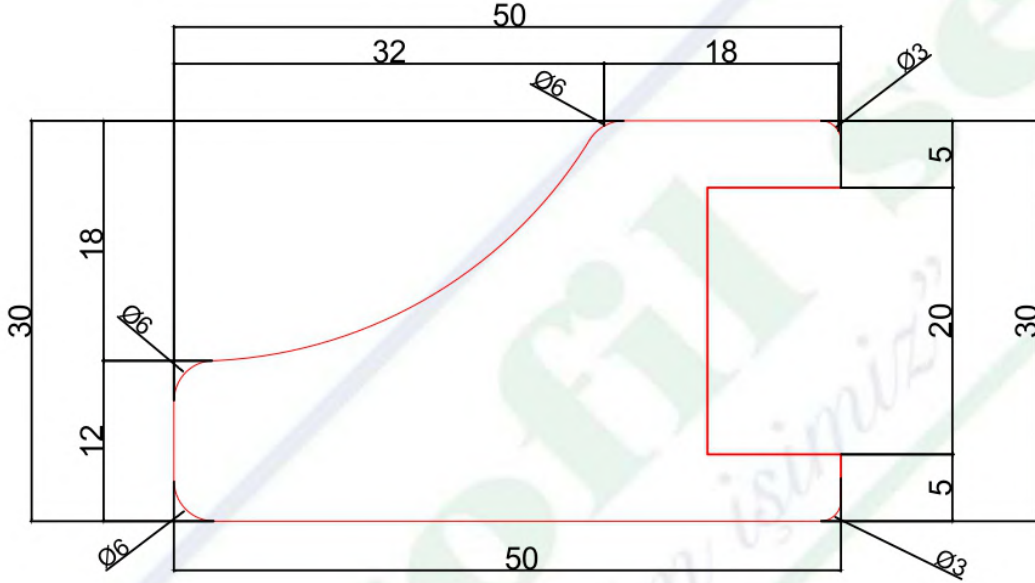

BÖLÜM SORUMLUSU NEJDET ALTINTOPRAK	BU ÇİZİM PROFİLSE - SİLAS ORMAN ÜRÜNLERİ'NE AİTTİR. İZINSİZ ÇOĞALTILMAMAK VE KOPYA EDİLMEMEK ŞARTI İLE İZİN VERİLMİŞTİR.	PVC ENİ : MDF MİKTARI : PLAKADAN ÇIKAN :	KSM ÖLÇÜCÜ :	KUTU İÇİ : KUTU İÇİ ADET :
ARGE SORUMLUSU DOĞUKAN DEMİR	THIS DRAWING PROFILE - SİLAS FOREST PRODUCTS WHAT TO DO. UNLOCKED AND COPY NOT ALLOWED WITH THE WRITTEN.	GENEL TOLERANS : PROFİL BOY TOLERANSI :	MATERİYAL MM MDF	TARİH / DATE 26.11.2018

30 mm Profiles

PROFİLSE - SİLAS ORMAN ÜRÜNLERİ

KAĞIT ÜZERİNDEN ÖLÇÜ ALMAYINIZ !!!
Don't measure on paper.

ÜRÜN KODU : 30*45
(Product Code)

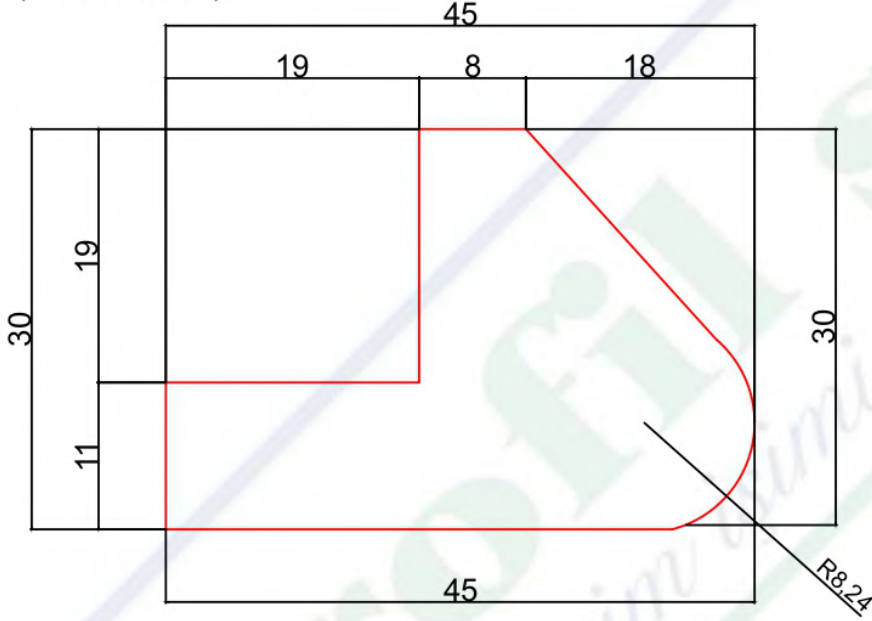

PVC BİTİŞ YERİ
(Pvc ending area)

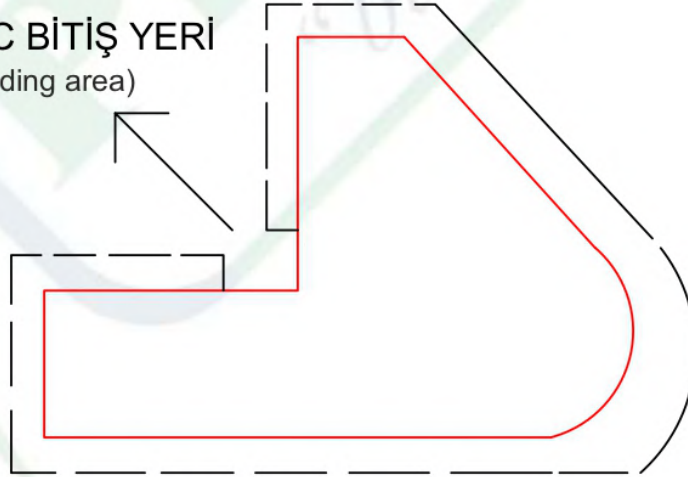

BÖLÜM SORUMLUSU NEJDET ALTINTOPRAK	BU ÇİZİM PROFİLSE - SİLAS ORMAN ÜRÜNLERİ'NE AİTTİR. İZİNSİZ ÇOĞALTILMAMAK VE KOPYA EDİLMEKEMEK ŞARTI İLE İZİN VERİLMİŞTİR.	PVC ENİ : MDF MİKTARI : PLAKADAN ÇIKAN :	KSM ÖLÇÜCÜ :	KUTU İÇİ : KUTU İÇİ ADET :
ARGE SORUMLUSU DOĞUKAN DEMİR	THIS DRAWING PROFILE - SİLAS FOREST PRODUCTS WHAT TO DO. UNLOCKED AND COPY NOT ALLOWED WITH THE WRITTEN.	GENEL TOLERANS : PROFL BOY TOLERANSI :	MATERİYAL MM MDF	TARİH / DATE 08.04.2019

30 mm Profiles

PROFİLSE - SİLAS ORMAN ÜRÜNLERİ

KAĞIT ÜZERİNDEN ÖLÇÜ ALMAYINIZ !!!

ÜRÜN KODU : 30*35
(Product Code)

Don't measurate on paper.

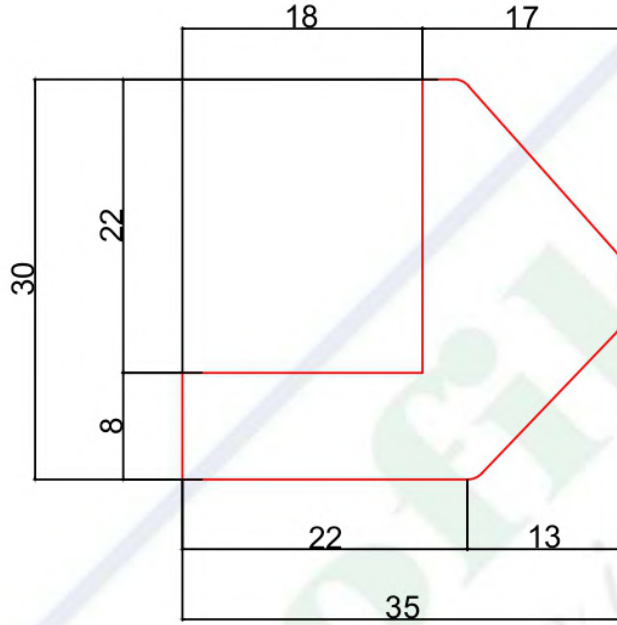

(Pvc ending area)

PVC BİTİŞ YERİ



BÖLÜM SORUMLUSU NEJDET ALTINTOPRAK	BU ÇİZİM PROFİLSE - SİLAS ORMAN ÜRÜNLERİ'NE AİTTİR. İZINSİZ ÇOĞALTILMAMAK VE KOPYA EDİLMEMEK ŞARTI İLE İZİN VERİLMİŞTİR.	PVC ENİ : MDF MİKTARI : PLAKADAN ÇIKAN :	KSM ÖLÇÜCÜ :	KUTU İÇİ : KUTU İÇİ ADET :
ARGE SORUMLUSU DOĞUKAN DEMİR	THIS DRAWING PROFILE - SİLAS FOREST PRODUCTS WHAT TO DO. UNLOCKED AND COPY NOT ALLOWED WITH THE WRITTEN.	GENEL TOLERANS : PROFL BOY TOLERANSI :	MATERİYAL MM MDF	TARİH / DATE 5.11.2018

30 mm Profiles

PROFİLSE - SİLAS ORMAN ÜRÜNLERİ

ÜRÜN KODU : 30*45

(Product Code)

KAĞIT ÜZERİNDEN ÖLÇÜ ALMAYINIZ !!!

Don't measurate on paper.

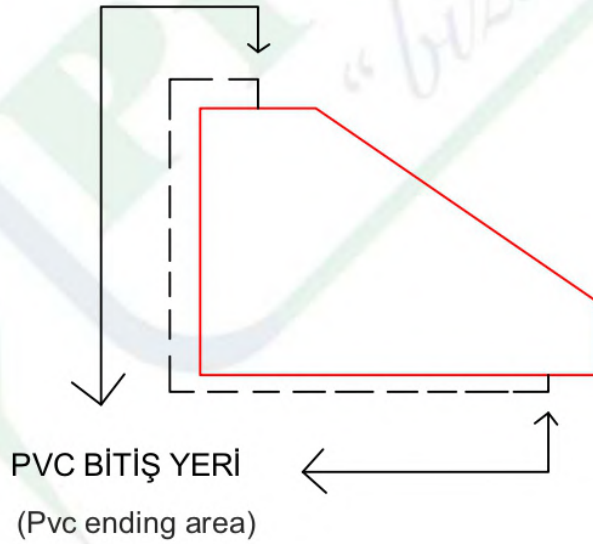
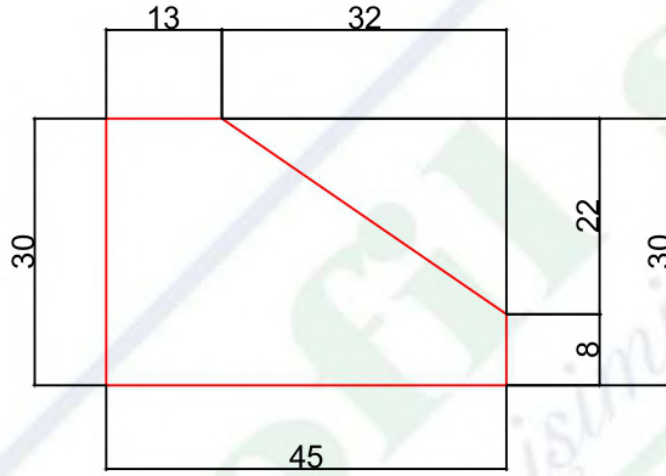

BÖLÜM SORUMLUSU NEJDET ALTINTOPRAK	BU ÇİZİM PROFİLSE - SİLAS ORMAN ÜRÜNLERİ'NE AİTTİR. İZINSİZ ÇOĞALTILMAMAK VE KOPYA EDİLMEMEK ŞARTI İLE İZİN VERİLMİŞTİR.	PVC ENİ : MDF MİKTARI : PLAKADAN ÇIKAN :	KSM ÖLÇÜCÜ :	KUTU İÇİ : KUTU İÇİ ADET :
ARGE SORUMLUSU DOĞUKAN DEMİR	THIS DRAWING PROFILE - SİLAS FOREST PRODUCTS WHAT TO DO. UNLOCKED AND COPY NOT ALLOWED WITH THE WRITTEN.	GENEL TOLERANS : PROFL BOY TOLERANSI :	MATERİYAL MM MDF	TARİH / DATE 12.11.2018

30 mm Profiles

PROFİLSE - SİLAS ORMAN ÜRÜNLERİ

KAĞIT ÜZERİNDEN ÖLÇÜ ALMAYINIZ !!!

Don't measure on paper.

ÜRÜN KODU : 30*32

(Product Code)

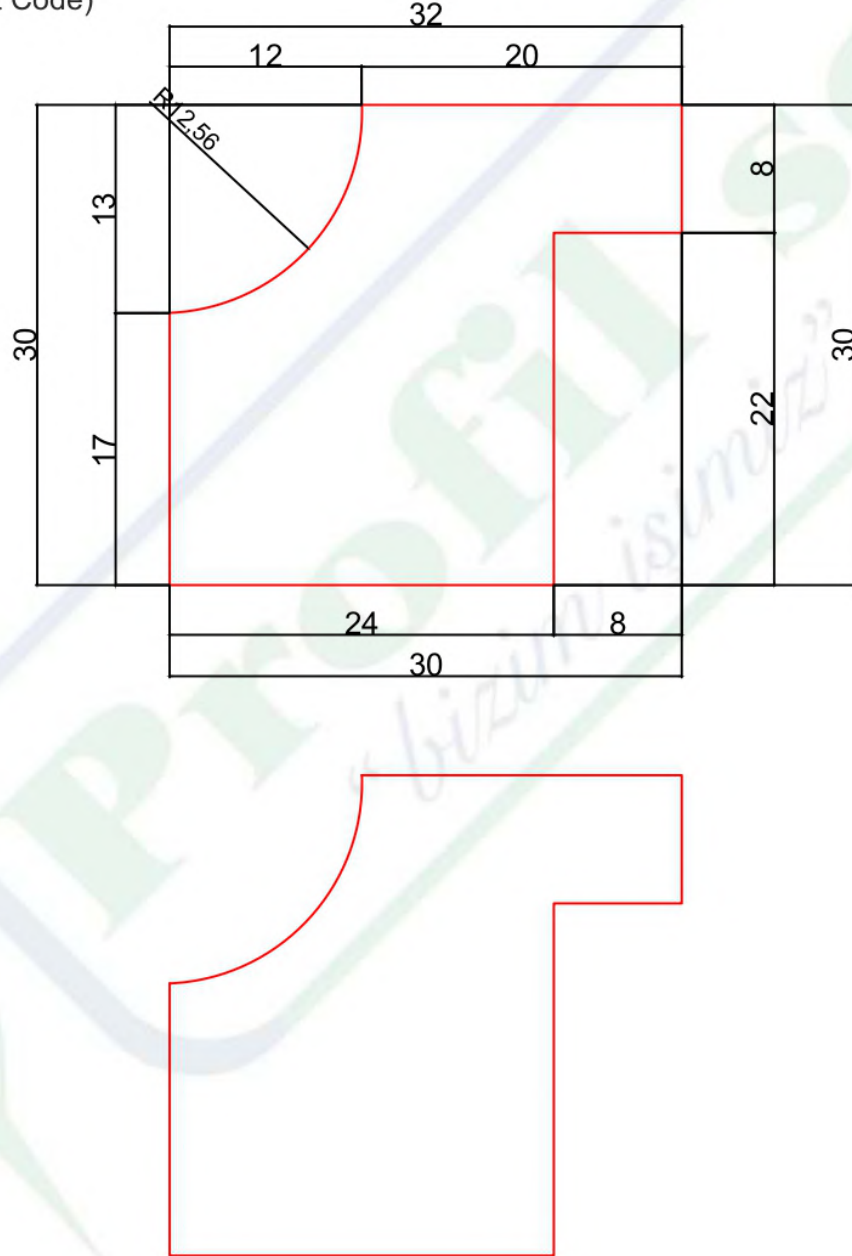

BÖLÜM SORUMLUSU NEJDET ALTINTOPRAK	BU ÇİZİM PROFİLSE - SİLAS ORMAN ÜRÜNLERİ'NE AİTTİR. İZİNSİZ ÇOĞALTILMAMAK VE KOPYA EDİLMEMEK ŞARTI İLE İZİN VERİLMİŞTİR.	PVC ENİ : MDF MİKTARI : PLAKADAN ÇIKAN :	KSM ÖLÇÜCÜ :	KUTU İÇİ : KUTU İÇİ ADET :
ARGE SORUMLUSU DOĞUKAN DEMİR	THIS DRAWING PROFILE - SİLAS FOREST PRODUCTS WHAT TO DO. UNLOCKED AND COPY NOT ALLOWED WITH THE WRITTEN.	GENEL TOLERANS : PROFL BOY TOLERANSI :	MATERİYAL MM MDF	TARİH / DATE 16.04.2019

30 mm Profiles

PROFİLSE - SİLAS ORMAN ÜRÜNLERİ

KAĞIT ÜZERİNDEN ÖLÇÜ ALMAYINIZ !!!

Don't measurate on paper.

ÜRÜN KODU : 30*37

(Product Code)

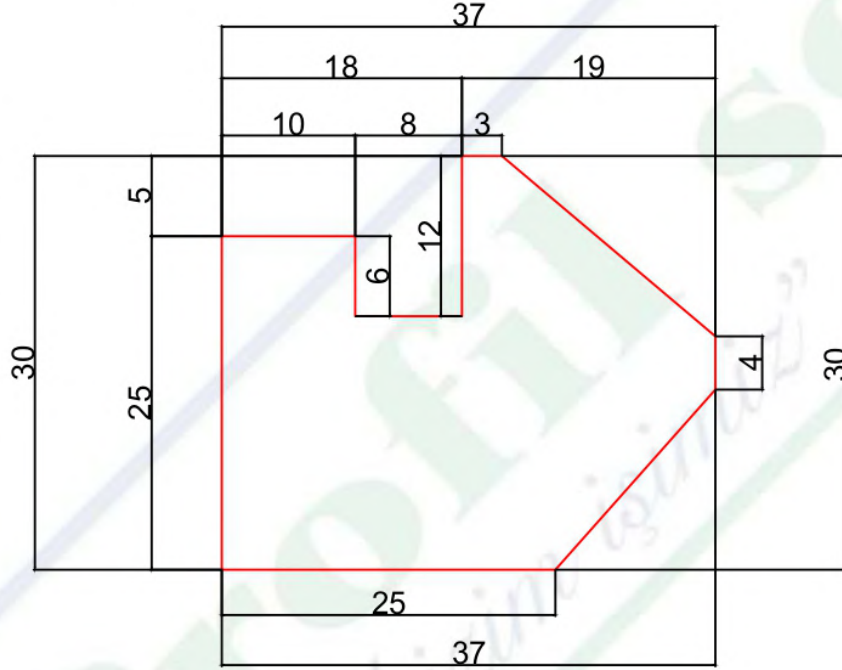

(Pvc ending area)

PVC BİTİŞ YERİ

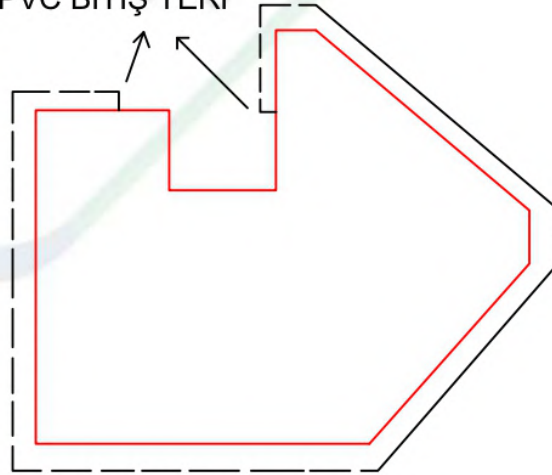

BÖLÜM SORUMLUSU NEJDET ALTINTOPRAK	BU ÇİZİM PROFİLSE - SİLAS ORMAN ÜRÜNLERİ'NE AİTTİR. İZİNSİZ ÇOĞALTILMAMAK VE KOPYA EDİLMEMEK ŞARTI İLE İZİN VERİLMİŞTİR.	PVC ENİ MDF MİKTARI PLAKADAN ÇIKAN	KSM ÖLÇÜCÜ	KUTU İÇİ KUTU İÇİ ADET
ARGE SORUMLUSU DOĞUKAN DEMİR	THIS DRAWING PROFILE - SİLAS FOREST PRODUCTS WHAT TO DO. UNLOCKED AND COPY NOT ALLOWED WITH THE WRITTEN.	GENEL TOLERANS PROFL BOY TOLERANSI	MATERIAL MM MDF	TARİH / DATE 16.04.2019

30 mm Profiles

PROFİLSE - SİLAS ORMAN ÜRÜNLERİ

KAĞIT ÜZERİNDEN ÖLÇÜ ALMAYINIZ !!!

ÜRÜN KODU : 30*17

Don't measurate on paper.

(Product Code)

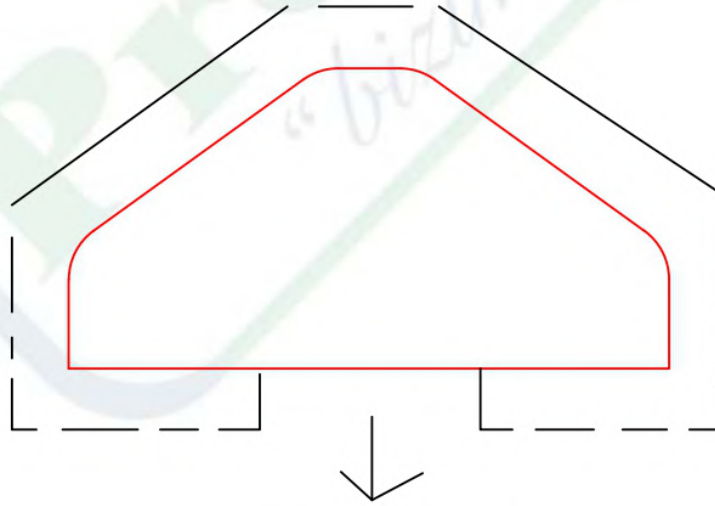
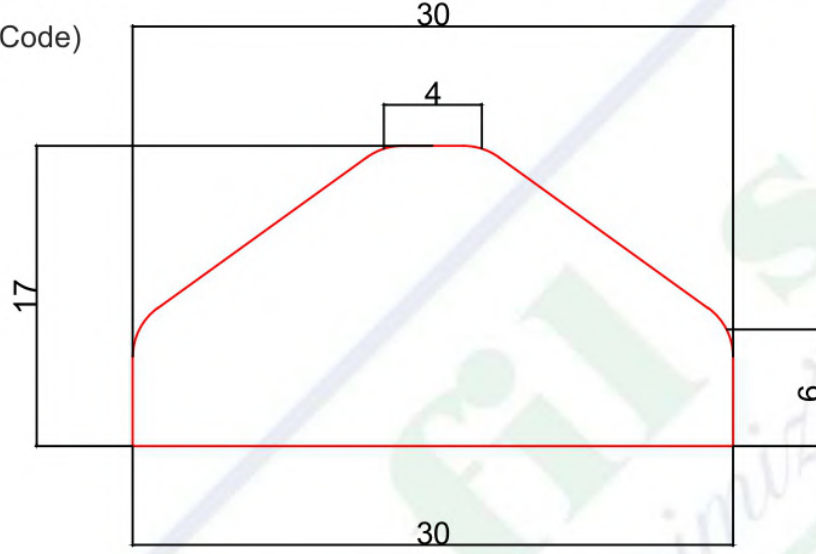

PVC BİTİŞ YERİ
(Pvc ending area)

BÖLÜM SORUMLUSU NEJDET ALTINTOPRAK	BU ÇİZİM PROFİLSE - SİLAS ORMAN ÜRÜNLERİ'NE AİTTİR. İZİNSİZ ÇOĞALTILMAMAK VE KOPYA EDİLMEK ŞARTI İLE İZİN VERİLMİŞTİR.	PVC ENİ : MDF MİKTARI : PLAKADAN ÇIKAN :	KSM ÖLÇÜCÜ :	KUTU İÇİ : KUTU İÇİ ADET :
ARGE SORUMLUSU DOĞUKAN DEMİR	THIS DRAWING PROFILE - SİLAS FOREST PRODUCTS WHAT TO DO. UNLOCKED AND COPY NOT ALLOWED WITH THE WRITTEN.	GENEL TOLERANS : PROFL BOY TOLERANSI :	MATERİAL MM MDF	TARİH / DATE 14.11.2018

30 mm Profiles

PROFİLSE - SİLAS ORMAN ÜRÜNLERİ

KAĞIT ÜZERİNDEN ÖLÇÜ ALMAYINIZ !!!

Don't measurate on paper.

ÜRÜN KODU : 30*44

(Product Code)

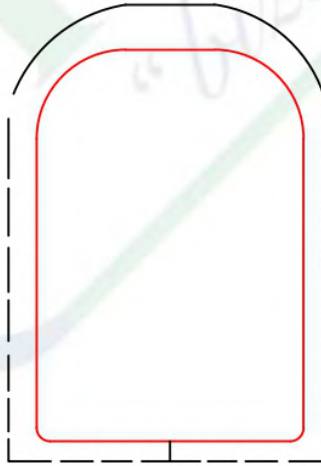
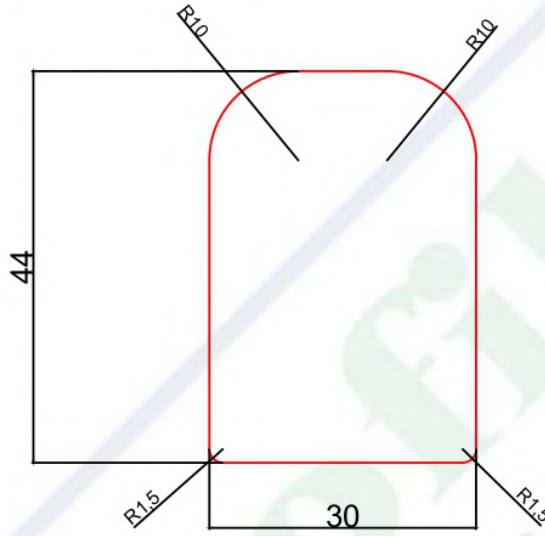

PVC BİTİŞ YERİ
(Pvc ending area)

BÖLÜM SORUMLUSU NEJDET ALTINTOPRAK	BU ÇİZİM PROFİLSE - SİLAS ORMAN ÜRÜNLERİ'NE AİTTİR. İZINSİZ ÇOĞALTILMAMAK VE KOPYA EDİLMEMEK ŞARTI İLE İZİN VERİLMİŞTİR.	PVC ENİ : MDF MİKTARI : PLAKADAN ÇIKAN :	KSM ÖLÇÜCÜ :	KUTU İÇİ : KUTU İÇİ ADET :
ARGE SORUMLUSU DOĞUKAN DEMİR	THIS DRAWING PROFILE - SİLAS FOREST PRODUCTS WHAT TO DO. UNLOCKED AND COPY NOT ALLOWED WITH THE WRITTEN.	GENEL TOLERANS : PROFİL BOY TOLERANSI :	MATERİYAL MM MDF	TARİH / DATE 10.12.2018

30 mm Profiles

PROFİLSE - SİLAS ORMAN ÜRÜNLERİ

KAĞIT ÜZERİNDEN ÖLÇÜ ALMAYINIZ !!!
Don't measure on paper.

ÜRÜN KODU : 30*65
(Product Code)

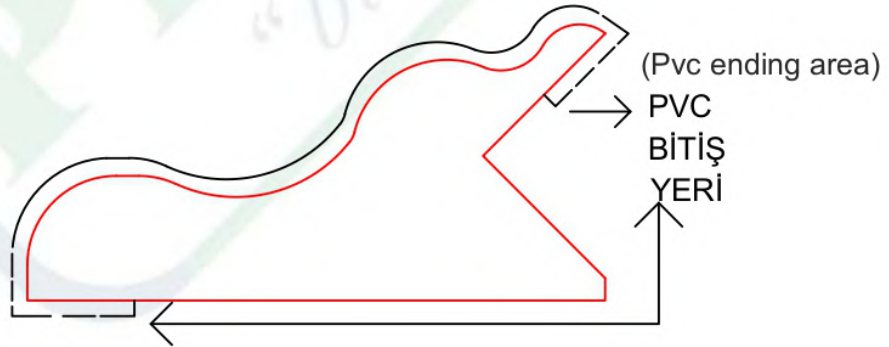
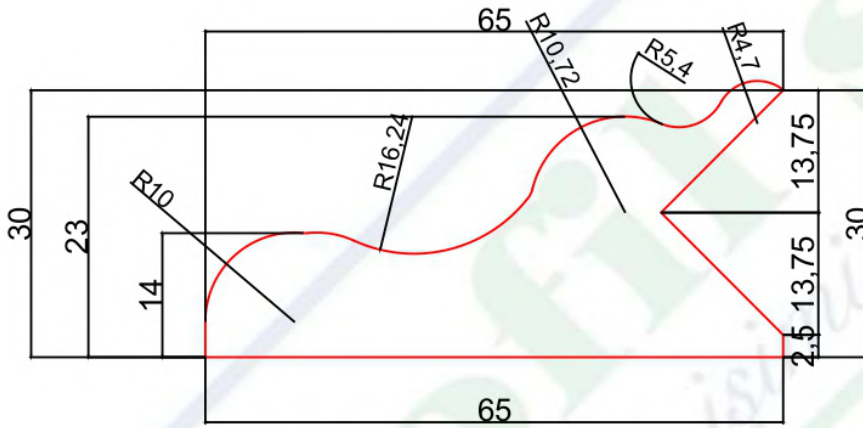

BÖLÜM SORUMLUSU NEJDET ALTINTOPRAK	BU ÇİZİM PROFİLSE - SİLAS ORMAN ÜRÜNLERİ'NE AİTTİR. İZINSİZ ÇOĞALTILMAMAK VE KOPYA EDİLMEMEK ŞARTI İLE İZİN VERİLMİŞTİR.	PVC ENİ : MDF MİKTARI : PLAKADAN ÇIKAN :	KSM ÖLÇÜCÜ :	KUTU İÇİ : KUTU İÇİ ADET :
ARGE SORUMLUSU DOĞUKAN DEMİR	THIS DRAWING PROFILE - SILAS FOREST PRODUCTS WHAT TO DO. UNLOCKED AND COPY NOT ALLOWED WITH THE WRITTEN.	GENEL TOLERANS : PROFİL BOY TOLERANSI :	MATERİYAL MM MDF	TARİH / DATE 03.04.2019

30 mm Profiles

PROFİLSE - SİLAS ORMAN ÜRÜNLERİ

KAGIT ÜZERİNDEN ÖLÇÜ ALMAYINIZ !!!

ÜRÜN KODU : 30*35

Don't measurate on paper.

(Product Code)

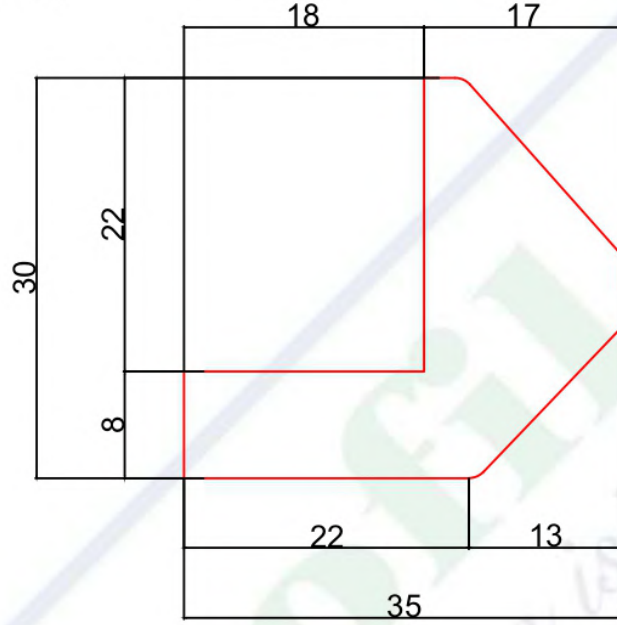

(Pvc ending area)

PVC BİTİŞ YERİ



BÖLÜM SORUMLUSU NEJDET ALTINTOPRAK	BU ÇİZİM PROFİLSE - SİLAS ORMAN ÜRÜNLERİ'NE AİTTİR. İZİNSİZ ÇOĞALTILMAMAK VE KOPYA EDİLMEMEK ŞARTI İLE İZİN VERİLMİŞTİR.	PVC ENİ : MDF MİKTARI : PLAKADAN ÇIKAN :	KSM ÖLÇÜCÜ :	KUTU İÇİ : KUTU İÇİ ADET :
ARGE SORUMLUSU DOĞUKAN DEMİR	THIS DRAWING PROFILE - SİLAS FOREST PRODUCTS WHAT TO DO. UNLOCKED AND COPY NOT ALLOWED WITH THE WRITTEN.	GENEL TOLERANS : PROFL BOY TOLERANSI :	MATERİYAL MM MDF	TARİH / DATE 5.11.2018

30 mm Profiles

PROFİLSE - SİLAS ORMAN ÜRÜNLERİ

KAĞIT ÜZERİNDEN ÖLÇÜ ALMAYINIZ !!!
Don't measure on paper.

ÜRÜN KODU : 30*36
(Product Code)

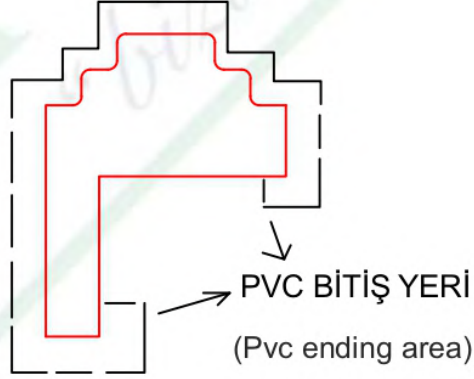
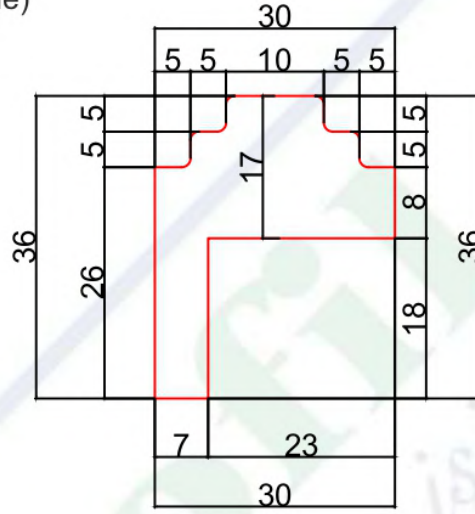

BÖLÜM SORUMLUSU NEJDET ALTINTOPRAK	BU ÇİZİM PROFİLSE - SİLAS ORMAN ÜRÜNLERİ'NE AİTTİR. İZİNSİZ ÇOĞALTILMAMAK VE KOPYA EDİLMEMEK ŞARTI İLE İZİN VERİLMİŞTİR.	PVC ENİ : MDF MİKTARI : PLAKADAN ÇIKAN :	KSM ÖLÇÜCÜ :	KUTU İÇİ : KUTU İÇİ ADET :
ARGE SORUMLUSU DOĞUKAN DEMİR	THIS DRAWING PROFILE - SİLAS FOREST PRODUCTS WHAT TO DO. UNLOCKED AND COPY NOT ALLOWED WITH THE WRITTEN.	GENEL TOLERANS : PROFİL BOY TOLERANSI :	MATERİYAL MM MDF	TARİH / DATE 04.10.2018

30 mm Profiles

PROFİLSE - SİLAS ORMAN ÜRÜNLERİ

ÜRÜN KODU : 30*35
(Product Code)

KAĞIT ÜZERİNDEN ÖLÇÜ ALMAYINIZ !!!
Don't measure on paper.

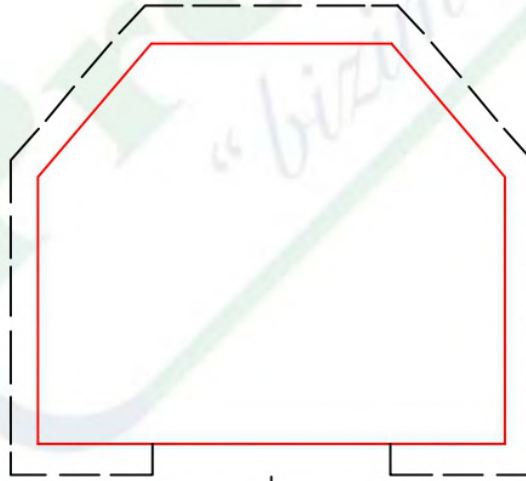
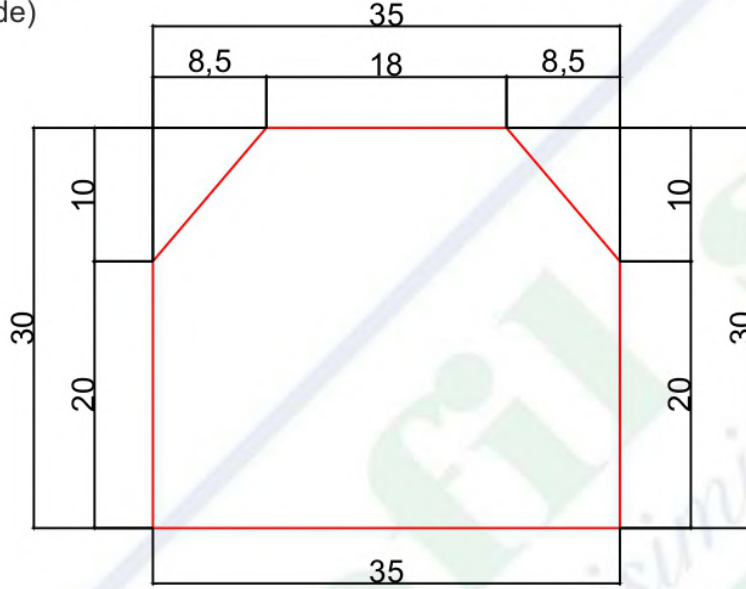

PVC BİTİŞ YERİ
(Pvc ending area)

BÖLÜM SORUMLUSU NEJDET ALTINTOPRAK	BU ÇİZİM PROFİLSE - SİLAS ORMAN ÜRÜNLERİ'NE AİTTİR. İZINSİZ ÇOĞALTILMAMAK VE KOPYA EDİLMEKEMEK ŞARTI İLE İZİN VERİLMİŞTİR.	PVC ENİ : MDF MİKTARI : PLAKADAN ÇIKAN :	KSM ÖLÇÜCÜ :	KUTU İÇİ : KUTU İÇİ ADET :
ARGE SORUMLUSU DOĞUKAN DEMİR	THIS DRAWING PROFILE - SİLAS FOREST PRODUCTS WHAT TO DO. UNLOCKED AND COPY NOT ALLOWED WITH THE WRITTEN.	GENEL TOLERANS : PROFİL BOY TOLERANSI :	MATERIAL MM MDF	TARİH / DATE 23.01.2019

30 mm Profiles

PROFİLSE - SİLAS ORMAN ÜRÜNLERİ

KAĞIT ÜZERİNDEN ÖLÇÜ ALMAYINIZ !!!

Don't measure on paper.

ÜRÜN KODU : 30*65

(Product Code)

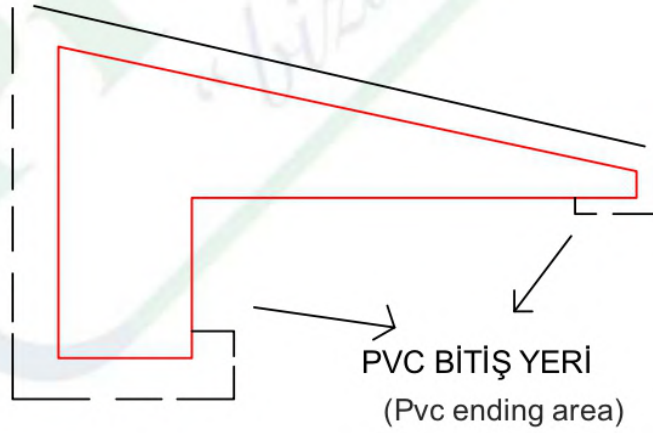
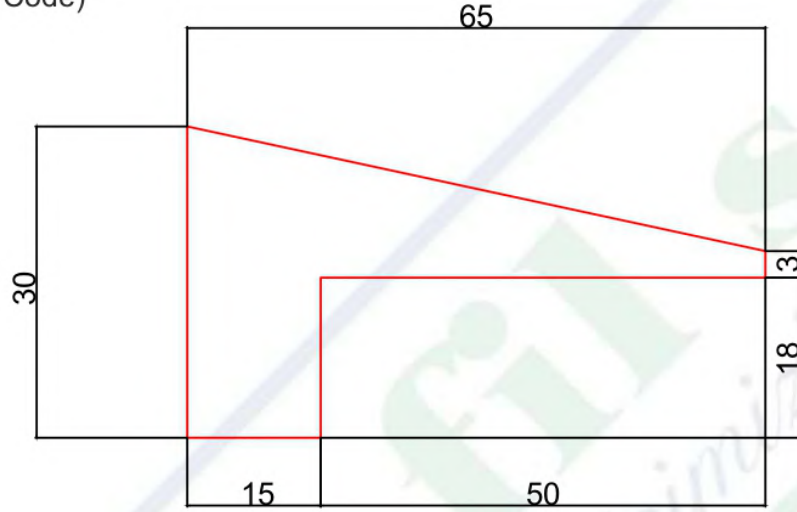

BÖLÜM SORUMLUSU NEJDET ALTINTOPRAK	BU ÇİZİM PROFİLSE - SİLAS ORMAN ÜRÜNLERİ'NE AİTTİR. İZINSİZ ÇOĞALTILMAMAK VE KOPYA EDİLMEMEK ŞARTI İLE İZİN VERİLMİŞTİR.	PVC ENİ : MDF MİKTARI : PLAKADAN ÇIKAN :	KSM ÖLÇÜCÜ :	KUTU İÇİ : KUTU İÇİ ADET :
ARGE SORUMLUSU DOĞUKAN DEMİR	THIS DRAWING PROFILE - SİLAS FOREST PRODUCTS WHAT TO DO. UNLOCKED AND COPY NOT ALLOWED WITH THE WRITTEN.	GENEL TOLERANS : PROFİL BOY TOLERANSI :	MATERIAL MM MDF	TARİH / DATE 04.10.2018

30 mm Profiles

PROFİLSE - SİLAS ORMAN ÜRÜNLERİ

KAĞIT ÜZERİNDEN ÖLÇÜ ALMAYINIZ !!!

Don't measure on paper.

ÜRÜN KODU : 30*45

(Product Code)

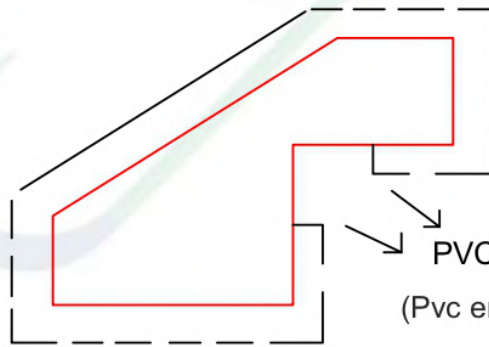
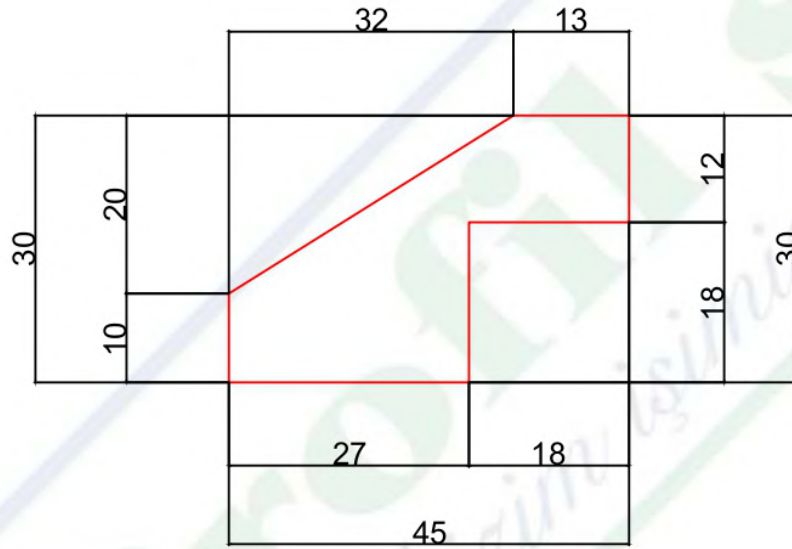

PVC BİTİŞ YERİ
(Pvc ending area)

BÖLÜM SORUMLUSU NEJDET ALTINTOPRAK	BU ÇİZİM PROFİLSE - SİLAS ORMAN ÜRÜNLERİ'NE AİTTİR. İZINSİZ ÇOĞALTILMAMAK VE KOPYA EDİLMEMEK ŞARTI İLE İZİN VERİLMİŞTİR.	PVC ENİ : MDF MİKTARI : PLAKADAN ÇIKAN :	KSM ÖLÇÜCÜ :	KUTU İÇİ : KUTU İÇİ ADET :
ARGE SORUMLUSU DOĞUKAN DEMİR	THIS DRAWING PROFILE - SİLAS FOREST PRODUCTS WHAT TO DO. UNLOCKED AND COPY NOT ALLOWED WITH THE WRITTEN.	GENEL TOLERANS : PROFL BOY TOLERANSI :	MATERIAL MM MDF	TARİH / DATE 12.11.2018

30 mm Profiles

PROFİLSE - SİLAS ORMAN ÜRÜNLERİ

KAĞIT ÜZERİNDEN ÖLÇÜ ALMAYINIZ !!!

Don't measurate on paper.

ÜRÜN KODU : 30*45

(Product Code)

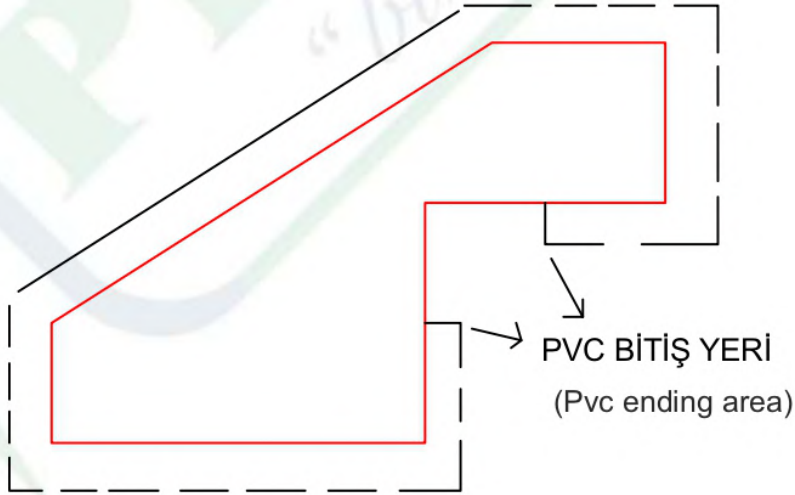
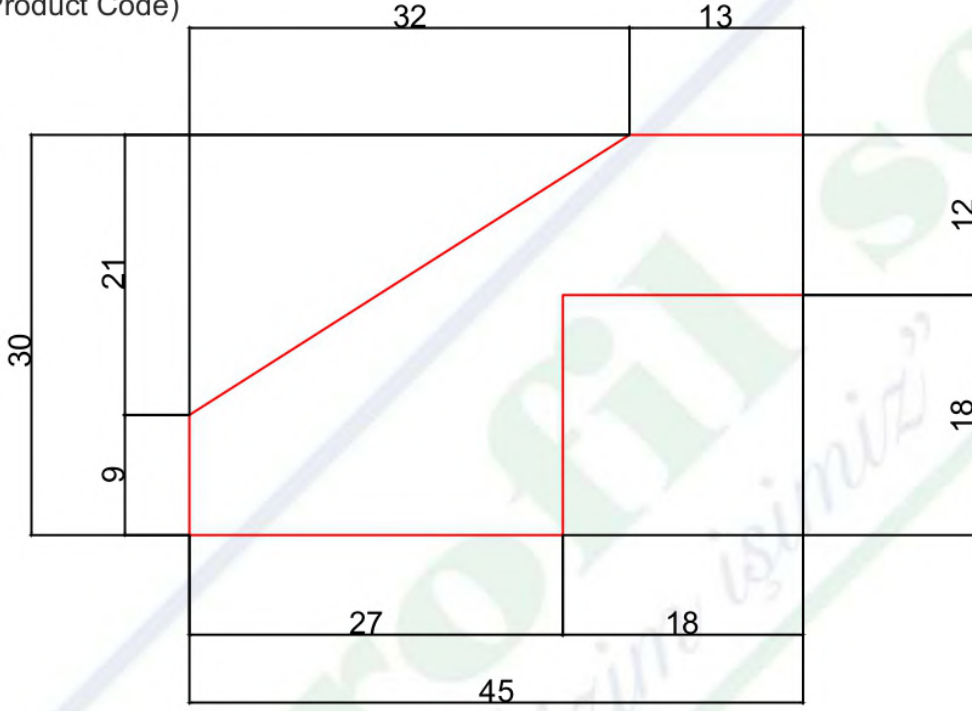

BÖLÜM SORUMLUSU NEJDET ALTINTOPRAK	BU ÇİZİM PROFİLSE - SİLAS ORMAN ÜRÜNLERİ'NE AİTTİR. İZINSİZ ÇOĞALTILMAMAK VE KOPYA EDİLMEK ŞARTI İLE İZİN VERİLMİŞTİR.	PVC ENİ : MDF MİKTARI : PLAKADAN ÇIKAN :	KSM ÖLÇÜCÜ :	KUTU İÇİ : KUTU İÇİ ADET :
ARGE SORUMLUSU DOĞUKAN DEMİR	THIS DRAWING PROFILE - SILAS FOREST PRODUCTS WHAT TO DO. UNLOCKED AND COPY NOT ALLOWED WITH THE WRITTEN.	GENEL TOLERANS : PROFİL BOY TOLERANSI :	MATERİYAL MM MDF	TARİH / DATE 12.11.2018

30 mm Profiles

PROFİLSE - SİLAS ORMAN ÜRÜNLERİ

KAĞIT ÜZERİNDEN ÖLÇÜ ALMAYINIZ !!!

Don't measurate on paper.

ÜRÜN KODU : 30*37

(Product Code)

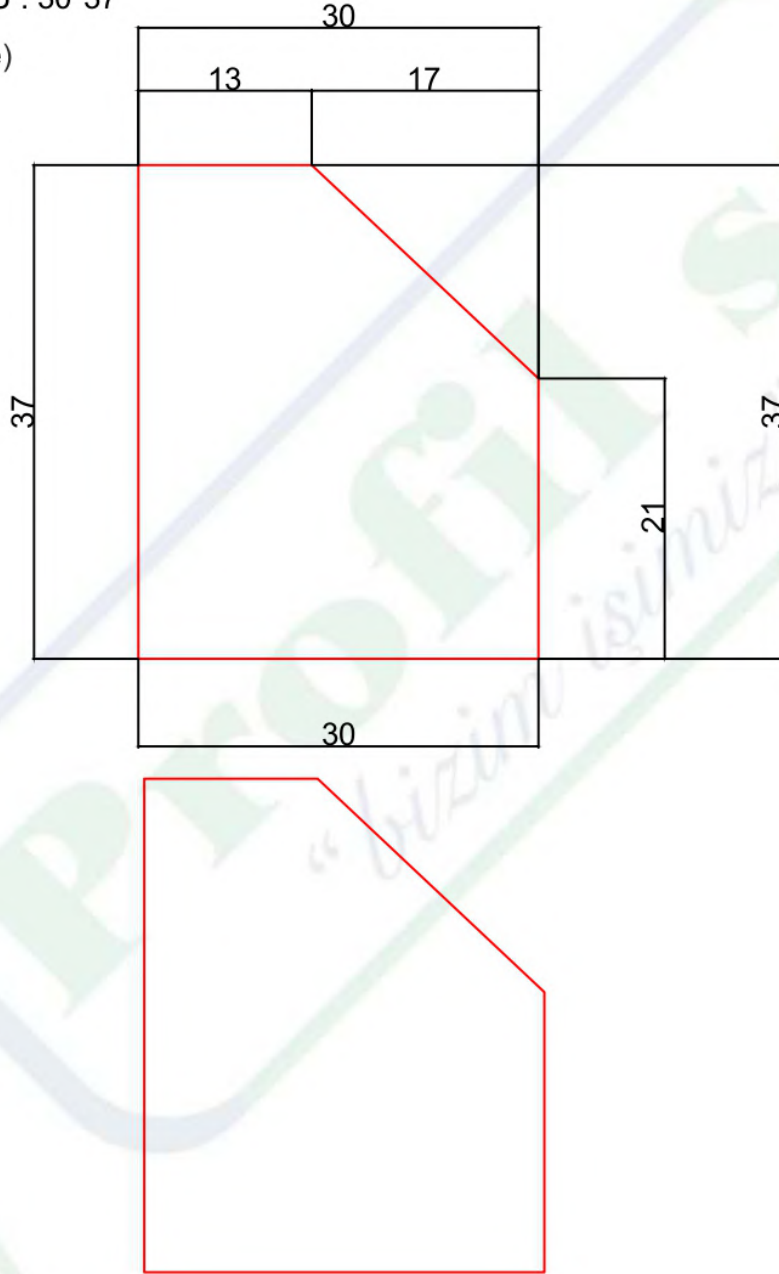

BÖLÜM SORUMLUSU NEJDET ALTINTOPRAK	BU ÇİZİM PROFİLSE - SİLAS ORMAN ÜRÜNLERİ'NE AİTTİR. İZINSİZ ÇOĞALTILMAMAK VE KOPYA EDİLMEMEK ŞARTI İLE İZİN VERİLMİŞTİR.	PVC ENİ : MDF MİKTARI : PLAKADAN ÇIKAN :	KSM ÖLÇÜCÜ :	KUTU İÇİ : KUTU İÇİ ADET :
ARGE SORUMLUSU DOĞUKAN DEMİR	THIS DRAWING PROFILE - SİLAS FOREST PRODUCTS WHAT TO DO. UNLOCKED AND COPY NOT ALLOWED WITH THE WRITTEN.	GENEL TOLERANS : PROFİL BOY TOLERANSI :	MATERİYAL MM MDF	TARİH / DATE 17.10.2018

30 mm Profiles

PROFİLSE - SİLAS ORMAN ÜRÜNLERİ

KAĞIT ÜZERİNDEN ÖLÇÜ ALMAYINIZ !!!

Don't measurate on paper.

ÜRÜN KODU : 30*35-01
(Product Code)

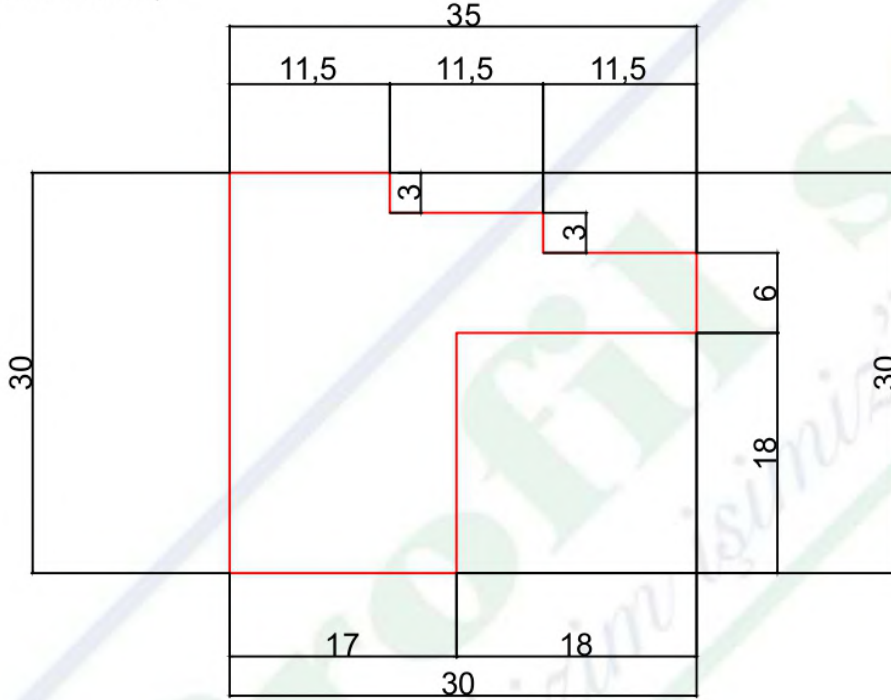

PVC BİTİŞ YERİ
(Pvc ending area)

BÖLÜM SORUMLUSU NEJDET ALTINTOPRAK	BU ÇİZİM PROFİLSE - SİLAS ORMAN ÜRÜNLERİ'NE AİTTİR. İZINSİZ ÇOĞALTILMAMAK VE KOPYA EDİLMEK ŞARTI İLE İZİN VERİLMİŞTİR.	PVC ENİ : MDF MİKTARI : PLAKADAN ÇIKAN :	KSM ÖLÇÜCÜ :	KUTU İÇİ : KUTU İÇİ ADET :
ARGE SORUMLUSU DOĞUKAN DEMİR	THIS DRAWING PROFILE - SİLAS FOREST PRODUCTS WHAT TO DO. UNLOCKED AND COPY NOT ALLOWED WITH THE WRITTEN.	GENEL TOLERANS : PROFİL BOY TOLERANSI :	MATERIAL MM MDF	TARİH / DATE 19.11.2018

30 mm Profiles

PROFİLSE - SİLAS ORMAN ÜRÜNLERİ

KAĞIT ÜZERİNDEN ÖLÇÜ ALMAYINIZ !!!

Don't measure on paper.

ÜRÜN KODU : 30*35

(Product Code)

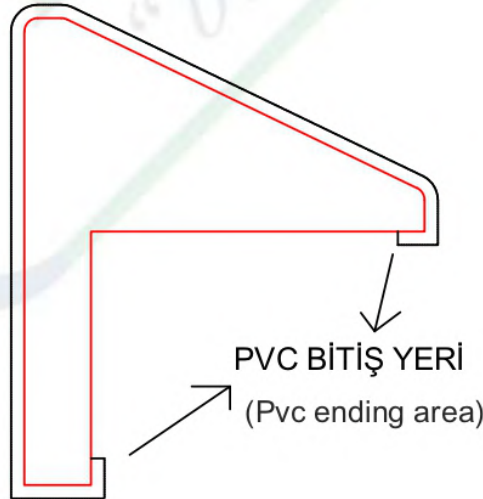
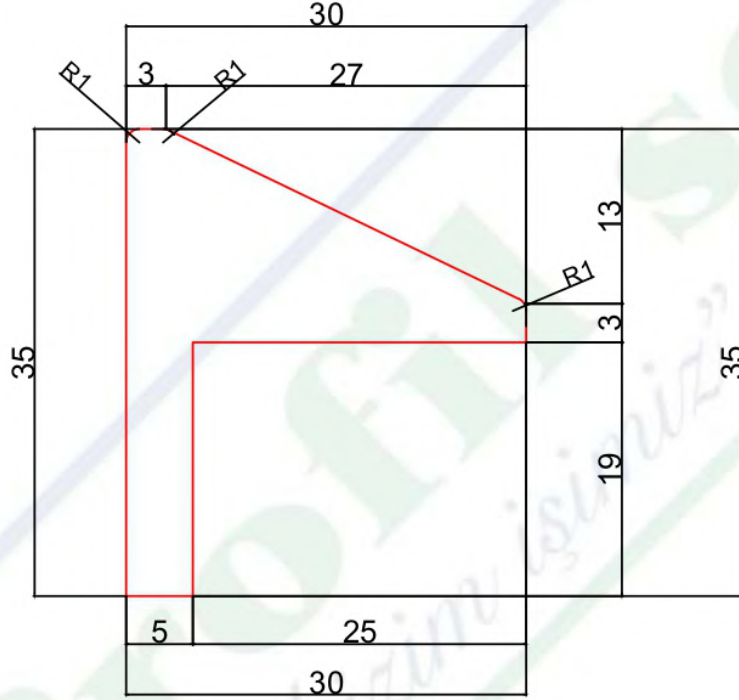

BÖLÜM SORUMLUSU NEJDET ALTINTOPRAK	BU ÇİZİM PROFİLSE - SİLAS ORMAN ÜRÜNLERİ'NE AİTTİR. İZINSİZ ÇOĞALTILMAMAK VE KOPYA EDİLMEKEMEK ŞARTI İLE İZİN VERİLMİŞTİR.	PVC ENİ : MDF MİKTARI : PLAKADAN ÇIKAN :	KSM ÖLÇÜCÜ :	KUTU İÇİ : KUTU İÇİ ADET :
ARGE SORUMLUSU DOĞUKAN DEMİR	THIS DRAWING PROFILE - SİLAS FOREST PRODUCTS WHAT TO DO. UNLOCKED AND COPY NOT ALLOWED WITH THE WRITTEN.	GENEL TOLERANS : PROFL BOY TOLERANSI :	MATERİYAL MM MDF	TARİH / DATE 07.01.2019

30 mm Profiles

PROFİLSE - SİLAS ORMAN ÜRÜNLERİ

KAĞIT ÜZERİNDEN ÖLÇÜ ALMAYINIZ !!!
Don't measure on paper.

ÜRÜN KODU : 30*50

(Product Code)

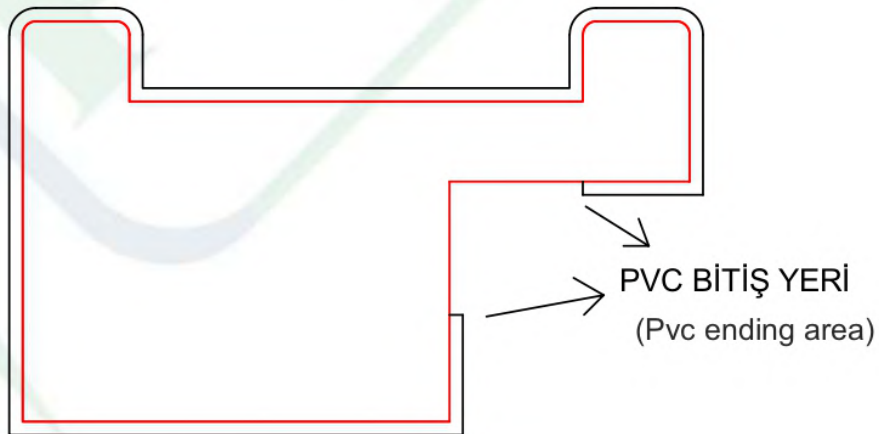
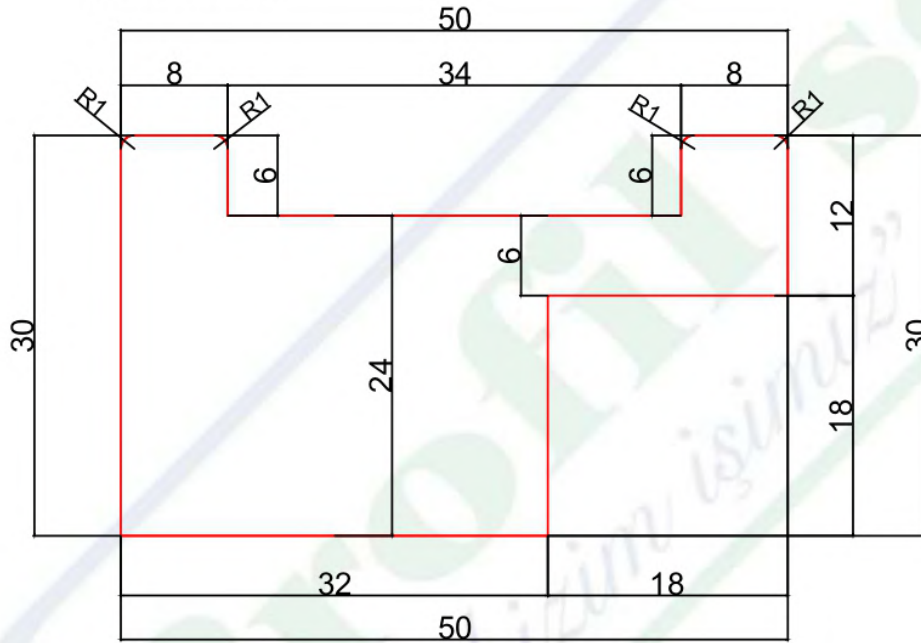

BÖLÜM SORUMLUSU NEJDET ALTINTOPRAK	BU ÇİZİM PROFİLSE - SİLAS ORMAN ÜRÜNLERİ'NE AİTTİR. İZINSİZ ÇOĞALTILMAMAK VE KOPYA EDİLMEKEMEK ŞARTI İLE İZİN VERİLMİŞTİR.	MDF MİKTARI : TABAKADAN ÇIKAN :	PVC ÖLÇÜSÜ :	KUTU İÇİ : KUTU İÇİ ADET :
ARGE SORUMLUSU DOĞUKAN DEMİR	THIS DRAWING PROFILE - SİLAS FOREST PRODUCTS WHAT TO DO. UNLOCKED AND COPY NOT ALLOWED WITH THE WRITTEN.	STANDART PROFİL BOY : PROFİL BOY :	MDF TÜRÜ : MM MDF	TARİH / DATE 18.04.2019

30 mm Profiles

PROFİLSE - SİLAS ORMAN ÜRÜNLERİ

KAĞIT ÜZERİNDEN ÖLÇÜ ALMAYINIZ !!!

Don't measurate on paper.

ÜRÜN KODU : 30*35

(Product Code)

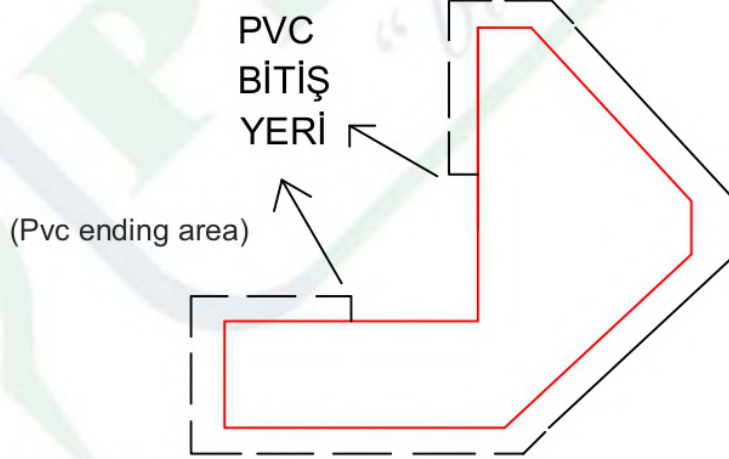
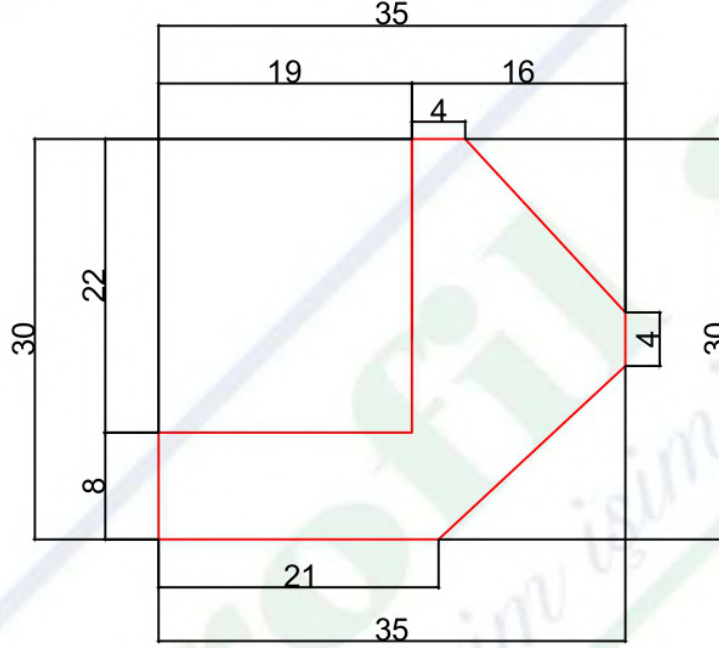

BÖLÜM SORUMLUSU NEJDET ALTINTOPRAK	BU ÇİZİM PROFİLSE - SİLAS ORMAN ÜRÜNLERİ 'NE AİTTİR. İZINSİZ ÇOĞALTILMAMAK VE KOPYA EDİLMEK ŞARTI İLE İZİN VERİLMİŞTİR.	PVC ENİ : MDF MİKTARI : PLAKADAN ÇIKAN :	KSM ÖLÇÜCÜ :	KUTU İÇİ : KUTU İÇİ ADET :
ARGE SORUMLUSU DOĞUKAN DEMİR	THIS DRAWING PROFILE - SİLAS FOREST PRODUCTS WHAT TO DO. UNLOCKED AND COPY NOT ALLOWED WITH THE WRITTEN.	GENEL TOLERANS : PROFİL BOY TOLERANSI :	MATERİYAL MM MDF	TARİH / DATE 07.02.2019

30 mm Profiles

PROFİLSE - SİLAS ORMAN ÜRÜNLERİ

KAĞIT ÜZERİNDEN ÖLÇÜ ALMAYINIZ !!!
Don't measurate on paper.

ÜRÜN KODU: 30*40
(Product Code)

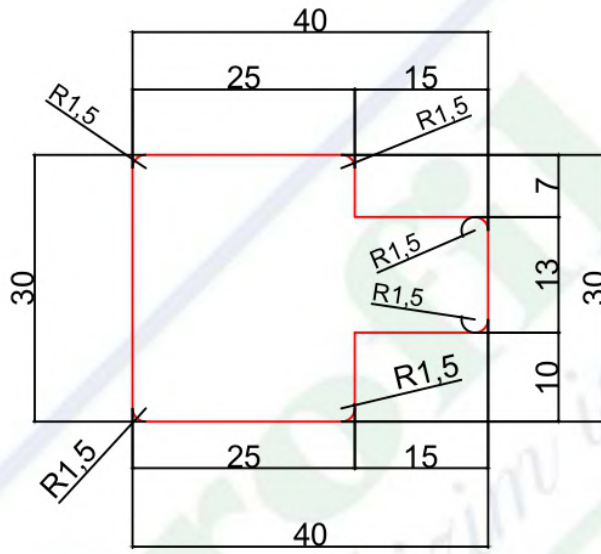

(Pvc ending area)
PVC BİTİŞ YERİ

BÖLÜM SORUMLUSU NEJDET ALTINTOPRAK	BU ÇİZİM PROFİLSE - SİLAS ORMAN ÜRÜNLERİ'NE AİTTİR. İZİNSİZ ÇOĞALTILMAMAK VE KOPYA EDİLMEMEK ŞARTI İLE İZİN VERİLMİŞTİR.	PVC ENİ : MDF MİKTARI : PLAKADAN ÇIKAN :	KSM ÖLÇÜCÜ :	KUTU İÇİ : KUTU İÇİ ADET :
ARGE SORUMLUSU DOĞUKAN DEMİR	THIS DRAWING PROFILE - SİLAS FOREST PRODUCTS WHAT TO DO. UNLOCKED AND COPY NOT ALLOWED WITH THE WRITTEN.	GENEL TOLERANS : PROFİL BOY TOLERANSI :	MATERIAL MM MDF	TARİH / DATE 20.12.2018

30 mm Profiles

PROFİLSE - SİLAS ORMAN ÜRÜNLERİ

ÜRÜN KODU : 30*37

(Product Code)

KAĞIT ÜZERİNDEN ÖLÇÜ ALMAYINIZ !!!

Don't measure on paper.

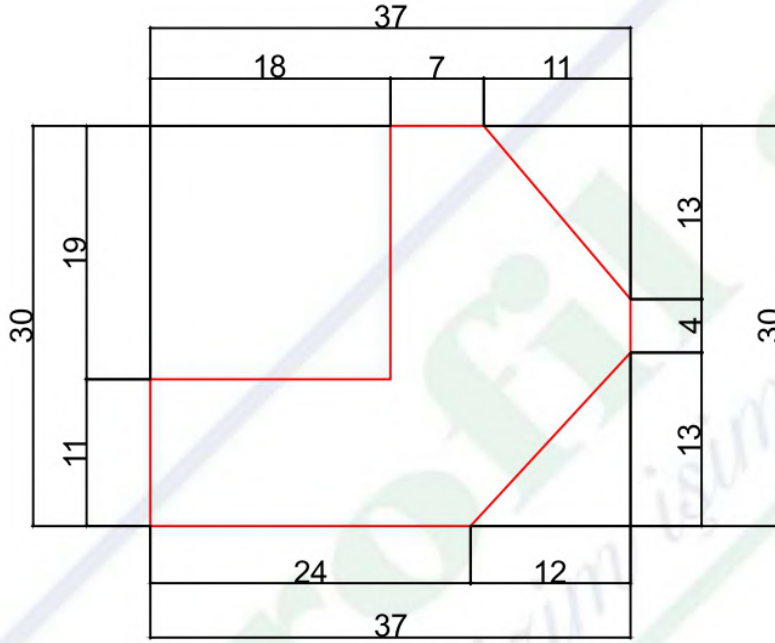

PVC BİTİŞ YERİ

(Pvc ending area)

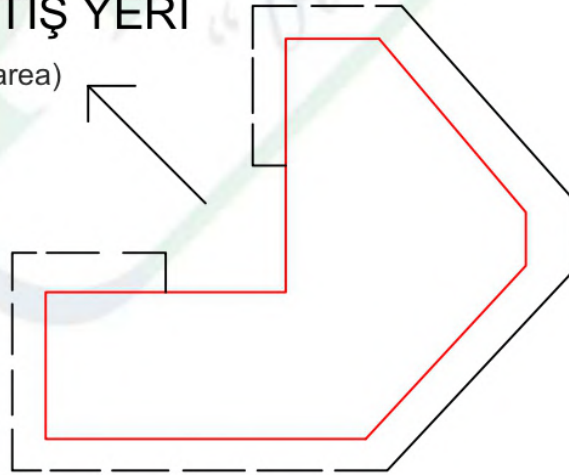

BÖLÜM SORUMLUSU NEJDET ALTINTOPRAK	BU ÇİZİM PROFİLSE - SİLAS ORMAN ÜRÜNLERİ'NE AİTTİR. İZINSİZ ÇOĞALTILMAMAK VE KOPYA EDİLMEKEMEK ŞARTI İLE İZİN VERİLMİŞTİR.	PVC ENİ : MDF MİKTARI : PLAKADAN ÇIKAN :	KSM ÖLÇÜCÜ :	KUTU İÇİ : KUTU İÇİ ADET :
ARGE SORUMLUSU DOĞUKAN DEMİR	THIS DRAWING PROFILE - SİLAS FOREST PRODUCTS WHAT TO DO. UNLOCKED AND COPY NOT ALLOWED WITH THE WRITTEN.	GENEL TOLERANS : PROFİL BOY TOLERANSI :	MATERIAL MM MDF	TARİH / DATE 08.04.2019

30 mm Profiles

PROFİLSE - SİLAS ORMAN ÜRÜNLERİ

KAGIT ÜZERİNDEN ÖLÇÜ ALMAYINIZ !!!

Don't measurate on paper.

ÜRÜN KODU: 30*50
(Product Code)

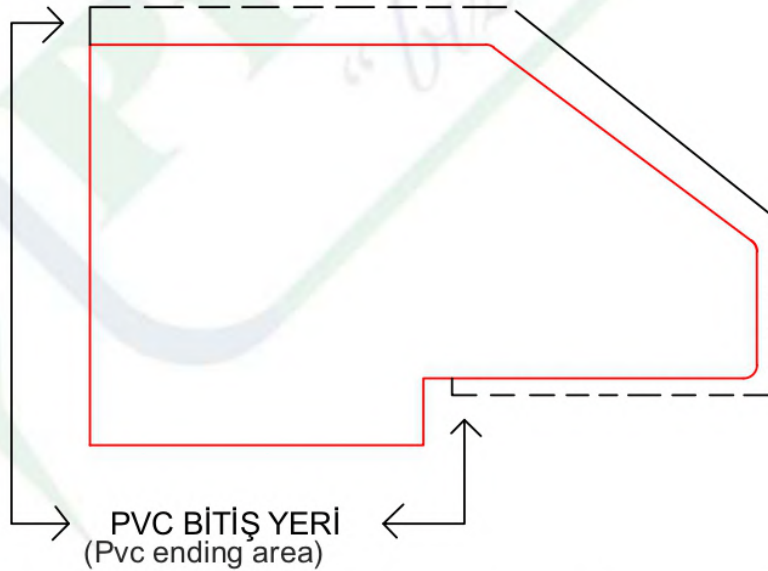
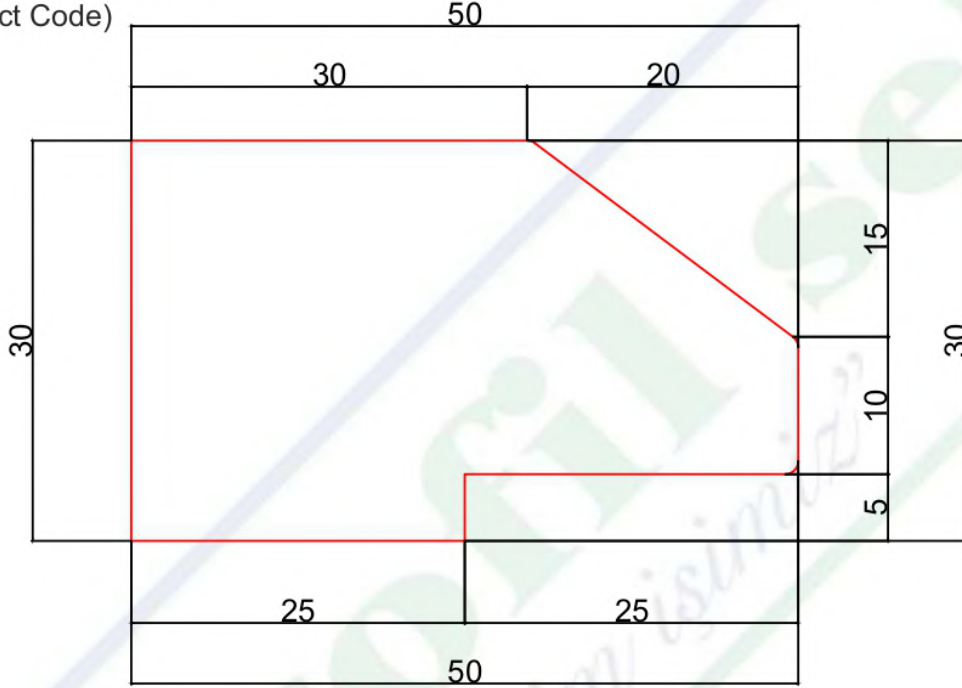

BÖLÜM SORUMLUSU NEJDET ALTINTOPRAK	BU ÇİZİM PROFİLSE - SİLAS ORMAN ÜRÜNLERİ'NE AITTİR. İZINSİZ ÇOĞALTILMAMAK VE KOPYA EDİLMEMEK ŞARTI İLE İZİN VERİLMİŞTİR.	PVC ENİ : MDF MİKTARI : PLAKADAN ÇIKAN :	KSM ÖLÇÜCÜ :	KUTU İÇİ : KUTU İÇİ ADET :
ARGE SORUMLUSU DOĞUKAN DEMİR	THIS DRAWING PROFILE - SİLAS FOREST PRODUCTS WHAT TO DO. UNLOCKED AND COPY NOT ALLOWED WITH THE WRITTEN.	GENEL TOLERANS : PROFİL BOY TOLERANSI :	MATERİYAL MM MDF	TARİH / DATE 14.11.2018

30 mm Profiles

PROFİLSE - SİLAS ORMAN ÜRÜNLERİ

KAĞIT ÜZERİNDEN ÖLÇÜ ALMAYINIZ !!!
Don't measure on paper.

ÜRÜN KODU : 30*65
(Product Code)

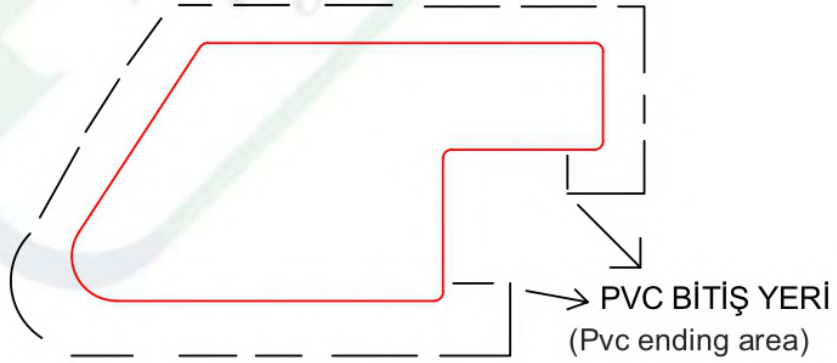
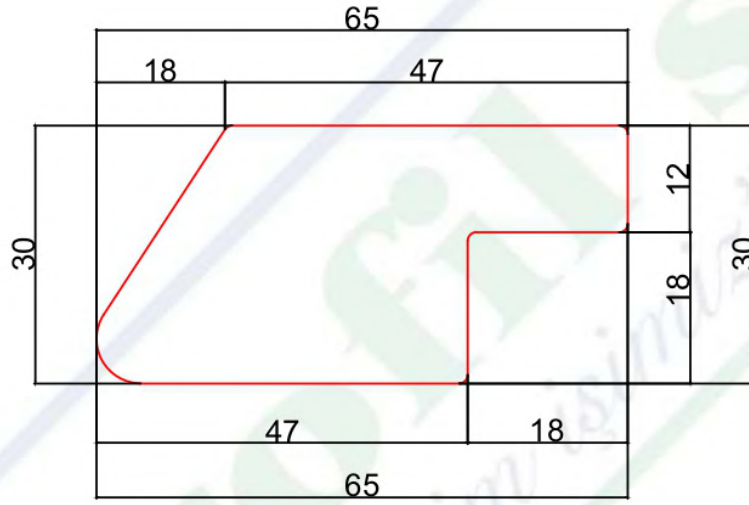

BÖLÜM SORUMLUSU NEJDET ALTINTOPRAK	BU ÇİZİM PROFİLSE - SİLAS ORMAN ÜRÜNLERİ'NE AİTTİR. İZİNSİZ ÇOĞALTILMAMAK VE KOPYA EDİLMEMEK ŞARTI İLE İZİN VERİLMİŞTİR.	PVC ENİ : MDF MİKTARI : PLAKADAN ÇIKAN :	KSM ÖLÇÜCÜ :	KUTU İÇİ : KUTU İÇİ ADET :
ARGE SORUMLUSU DOĞUKAN DEMİR	THIS DRAWING PROFILE - SİLAS FOREST PRODUCTS WHAT TO DO. UNLOCKED AND COPY NOT ALLOWED WITH THE WRITTEN.	GENEL TOLERANS : PROFİL BOY TOLERANSI :	MATERIAL MM MDF	TARİH / DATE 04.10.2018

30 mm Profiles

PROFİLSE - SİLAS ORMAN ÜRÜNLERİ

KAĞIT ÜZERİNDEN ÖLÇÜ ALMAYINIZ !!!

Don't measurate on paper.

ÜRÜN KODU : 30*64
(Product Code)

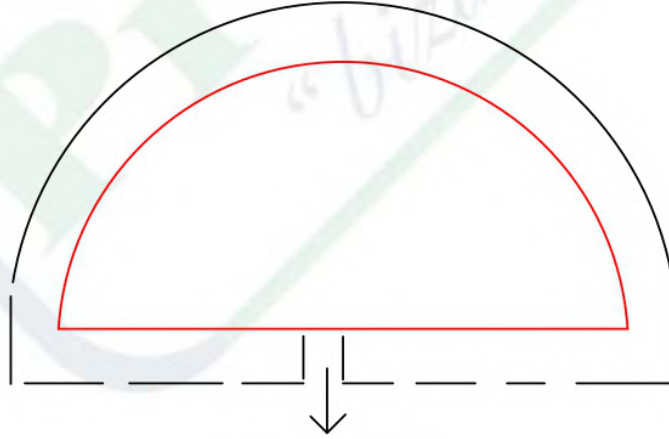
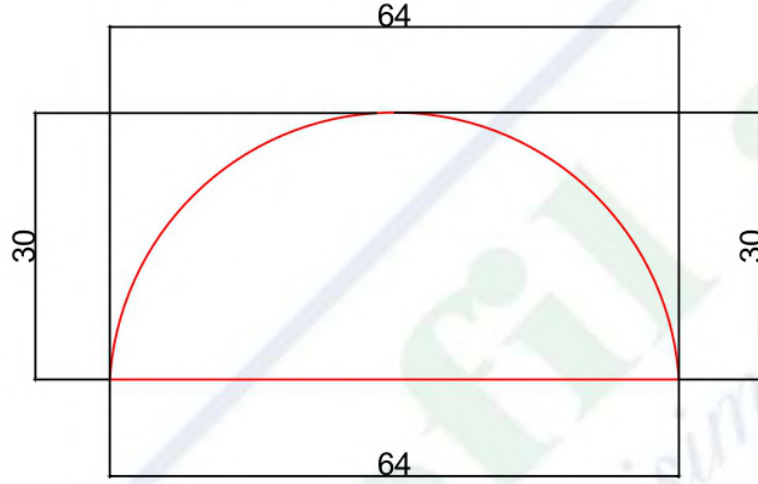

PVC BİTİŞ YERİ
(Pvc ending area)

BÖLÜM SORUMLUSU NEJDET ALTINTOPRAK	BU ÇİZİM PROFİLSE - SİLAS ORMAN ÜRÜNLERİ'NE AİTTİR. İZINSİZ ÇOĞALTILMAMAK VE KOPYA EDİLMEKEMEK ŞARTI İLE İZİN VERİLMİŞTİR.	PVC ENİ : MDF MİKTARI : PLAKADAN ÇIKAN :	KSM ÖLÇÜCÜ :	KUTU İÇİ : KUTU İÇİ ADET :
ARGE SORUMLUSU DOĞUKAN DEMİR	THIS DRAWING PROFILE - SİLAS FOREST PRODUCTS WHAT TO DO. UNLOCKED AND COPY NOT ALLOWED WITH THE WRITTEN.	GENEL TOLERANS : PROFİL BOY TOLERANSI :	MATERİYAL MM MDF	TARİH / DATE 04.10.2018

30 mm Profiles

PROFİLSE - SİLAS ORMAN ÜRÜNLERİ

KAĞIT ÜZERİNDEN ÖLÇÜ ALMAYINIZ !!!

Don't measurate on paper.

ÜRÜN KODU : 30*53

(Product Code)

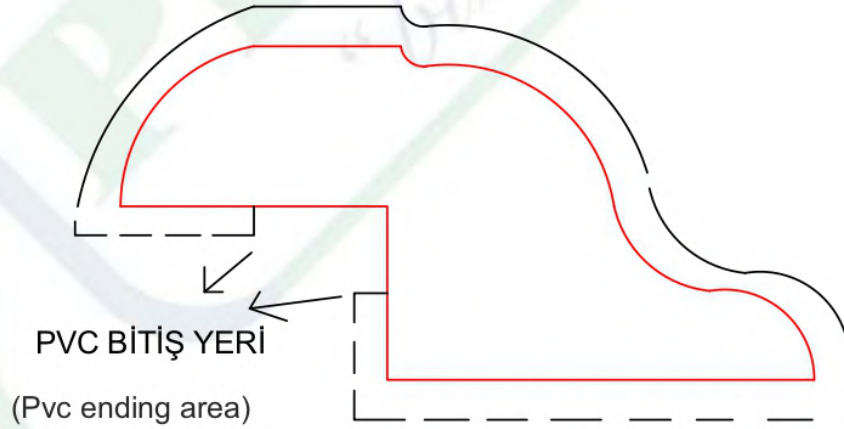
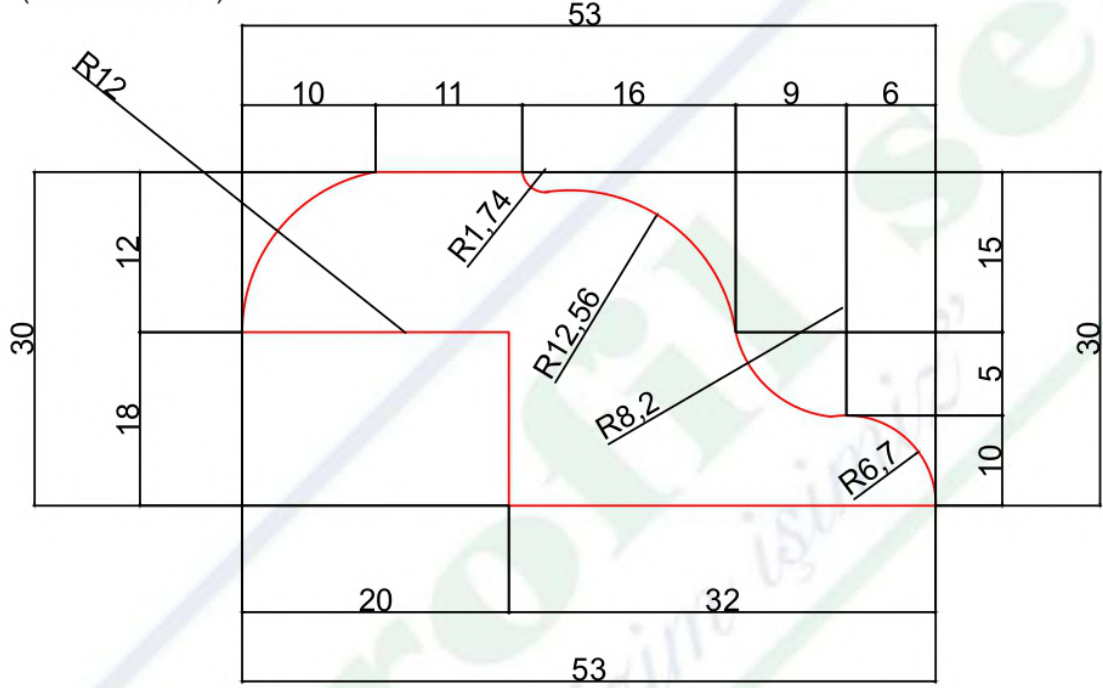

BÖLÜM SORUMLUSU NEJDET ALTINTOPRAK	BU ÇİZİM PROFİLSE - SİLAS ORMAN ÜRÜNLERİ'NE AİTTİR. İZİNSİZ ÇOĞALTILMAMAK VE KOPYA EDİLMEKEMEK ŞARTI İLE İZİN VERİLMİŞTİR.	PVC ENİ : MDF MİKTARI : PLAKADAN ÇIKAN :	KSM ÖLÇÜCÜ :	KUTU İÇİ : KUTU İÇİ ADET :
ARGE SORUMLUSU DOĞUKAN DEMİR	THIS DRAWING PROFILE - SİLAS FOREST PRODUCTS WHAT TO DO. UNLOCKED AND COPY NOT ALLOWED WITH THE WRITTEN.	GENEL TOLERANS : PROFİL BOY TOLERANSI :	MATERİYAL MM MDF	TARİH / DATE 30.11.2018

30 mm Profiles

PROFİLSE - SİLAS ORMAN ÜRÜNLERİ

KAĞIT ÜZERİNDEN ÖLÇÜ ALMAYINIZ !!!

ÜRÜN KODU : 30*30
(Product Code)

Don't measurate on paper.

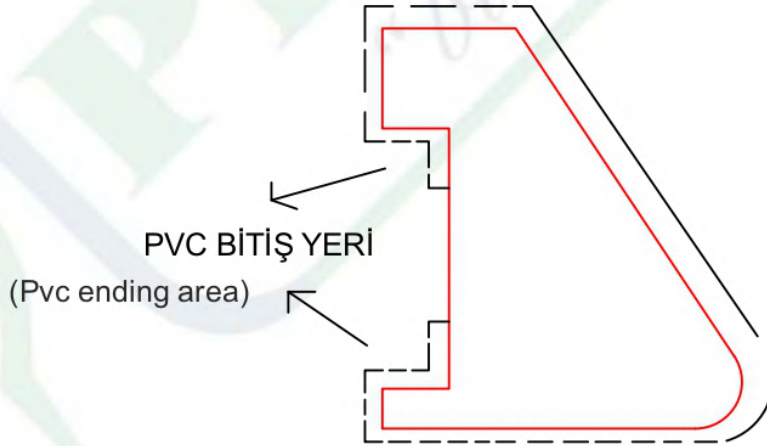
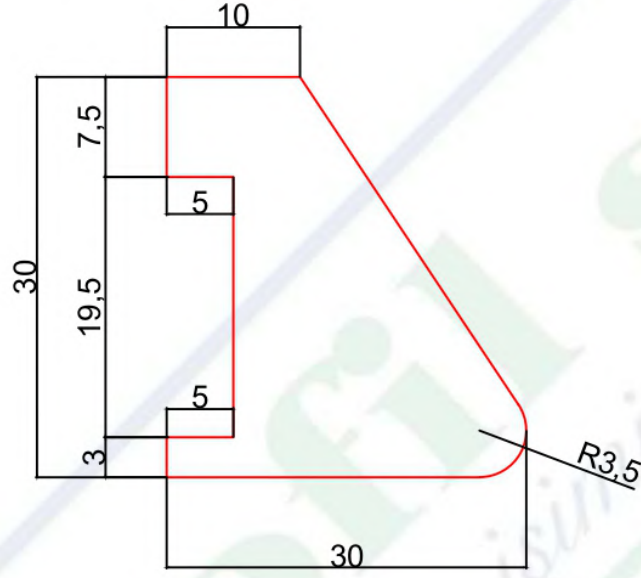

BÖLÜM SORUMLUSU NEJDET ALTINTOPRAK	BU ÇİZİM PROFİLSE - SİLAS ORMAN ÜRÜNLERİ'NE AİTTİR. İZINSİZ ÇOĞALTILMAMAK VE KOPYA EDİLMEMEK ŞARTI İLE İZİN VERİLMİŞTİR.	PVC ENİ : MDF MİKTARI : PLAKADAN ÇIKAN :	KSM ÖLÇÜCÜ :	KUTU İÇİ : KUTU İÇİ ADET :
ARGE SORUMLUSU DOĞUKAN DEMİR	THIS DRAWING PROFILE - SİLAS FOREST PRODUCTS WHAT TO DO. UNLOCKED AND COPY NOT ALLOWED WITH THE WRITTEN.	GENEL TOLERANS : PROFL BOY TOLERANSI :	MATERİAL MM MDF	TARİH / DATE 10.10.2018

30 mm Profiles

PROFİLSE - SİLAS ORMAN ÜRÜNLERİ

KAĞIT ÜZERİNDEN ÖLÇÜ ALMAYINIZ !!!

Don't measurate on paper.

ÜRÜN KODU : 30*55
(Product Code)

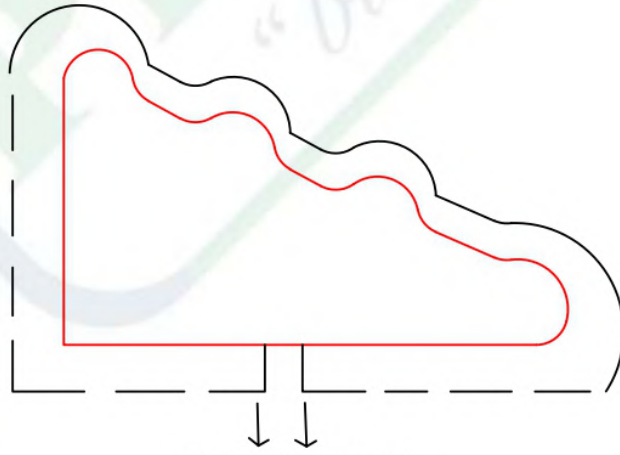
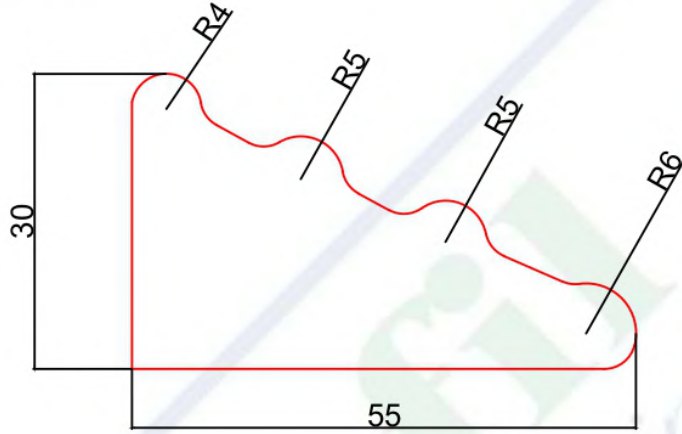

PVC BİTİŞ YERİ
(Pvc ending area)

BÖLÜM SORUMLUSU NEJDET ALTINTOPRAK	BU ÇİZİM PROFİLSE - SİLAS ORMAN ÜRÜNLERİ'NE AİTTİR. İZİNSİZ ÇOĞALTILMAMAK VE KOPYA EDİLMEMEK ŞARTI İLE İZİN VERİLMİŞTİR.	PVC ENİ : MDF MİKTARI : PLAKADAN ÇIKAN :	KSM ÖLÇÜCÜ :	KUTU İÇİ : KUTU İÇİ ADET :
ARGE SORUMLUSU DOĞUKAN DEMİR	THIS DRAWING PROFILE - SİLAS FOREST PRODUCTS WHAT TO DO. UNLOCKED AND COPY NOT ALLOWED WITH THE WRITTEN.	GENEL TOLERANS : PROFL BOY TOLERANSI :	MATERİYAL MM MDF	TARİH / DATE 10.10.2018

30 mm Profiles

PROFİLSE - SİLAS ORMAN ÜRÜNLERİ

KAĞIT ÜZERİNDEN ÖLÇÜ ALMAYINIZ !!!

Don't measurate on paper.

ÜRÜN KODU : 30*40

(Product Code)

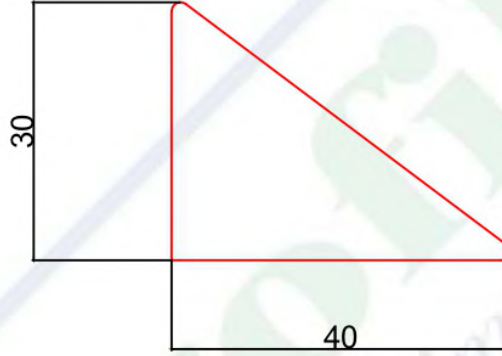

PVC BİTİŞ YERİ
(Pvc ending area)

BÖLÜM SORUMLUSU NEJDET ALTINTOPRAK	BU ÇİZİM PROFİLSE - SİLAS ORMAN ÜRÜNLERİ'NE AİTTİR. İZİNSİZ ÇOĞALTILMAMAK VE KOPYA EDİLMEKEMEK ŞARTI İLE İZİN VERİLMİŞTİR.	PVC ENİ : MDF MİKTARI : PLAKADAN ÇIKAN :	KSM ÖLÇÜCÜ :	KUTU İÇİ : KUTU İÇİ ADET :
ARGE SORUMLUSU DOĞUKAN DEMİR	THIS DRAWING PROFILE - SİLAS FOREST PRODUCTS WHAT TO DO. UNLOCKED AND COPY NOT ALLOWED WITH THE WRITTEN.	GENEL TOLERANS : PROFİL BOY TOLERANSI :	MATERIAL MM MDF	TARİH / DATE 03.10.2018

30 mm Profiles

PROFİLSE - SİLAS ORMAN ÜRÜNLERİ

KAĞIT ÜZERİNDEN ÖLÇÜ ALMAYINIZ !!!
Don't measure on paper.

ÜRÜN KODU : 30*57
(Product Code)

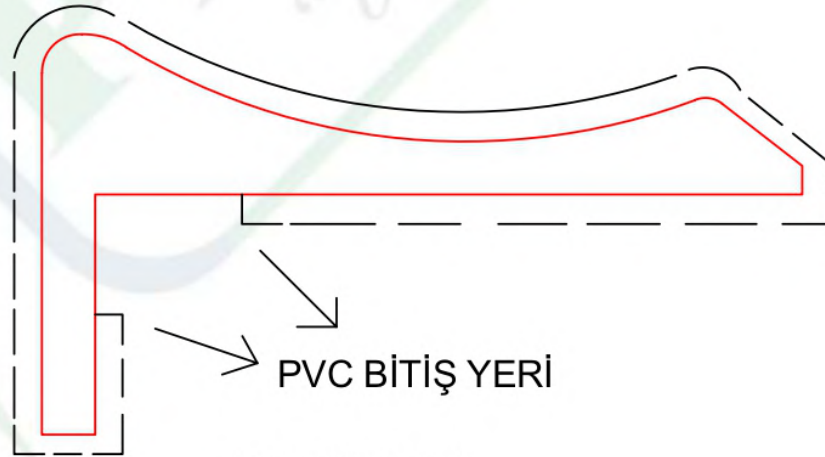
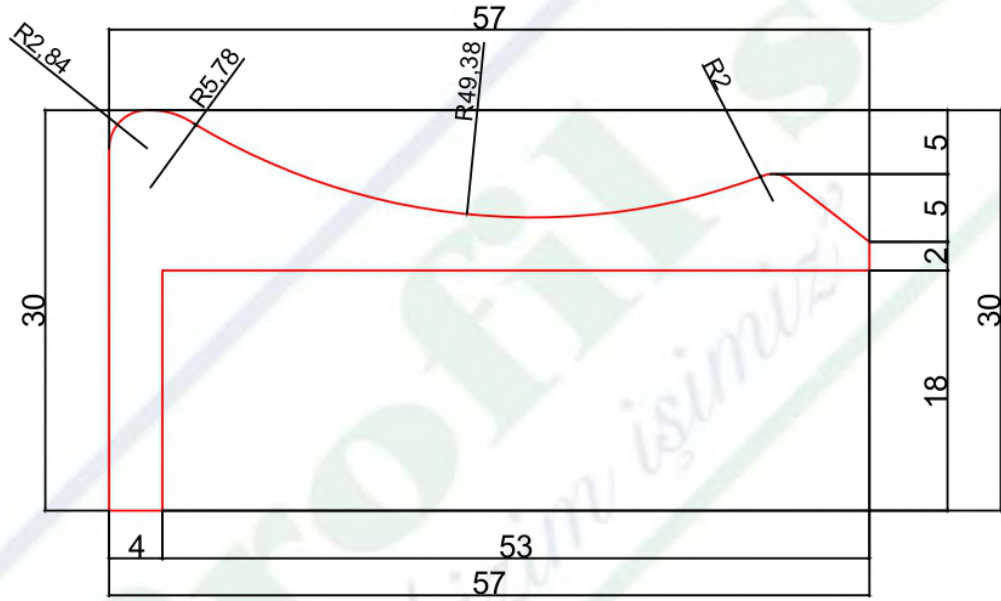

(Pvc ending area)

BÖLÜM SORUMLUSU NEJDET ALTINTOPRAK	BU ÇİZİM PROFİLSE - SİLAS ORMAN ÜRÜNLERİ'NE AİTTİR. İZİNSİZ ÇOĞALTILMAMAK VE KOPYA EDİLMEKEMEK ŞARTI İLE İZİN VERİLMİŞTİR.	PVC ENİ : MDF MİKTARI : PLAKADAN ÇIKAN :	KSM ÖLÇÜCÜ :	KUTU İÇİ : KUTU İÇİ ADET :
ARGE SORUMLUSU DOĞUKAN DEMİR	THIS DRAWING PROFILE - SİLAS FOREST PRODUCTS WHAT TO DO. UNLOCKED AND COPY NOT ALLOWED WITH THE WRITTEN.	GENEL TOLERANS : PROFL BOY TOLERANSI :	MATERİYAL MM MDF	TARİH / DATE 30.01.2019

30 mm Profiles

PROFİLSE - SİLAS ORMAN ÜRÜNLERİ

KAĞIT ÜZERİNDEN ÖLÇÜ ALMAYINIZ !!!
Don't measurate on paper.

ÜRÜN KODU : 30*50

(Product Code)

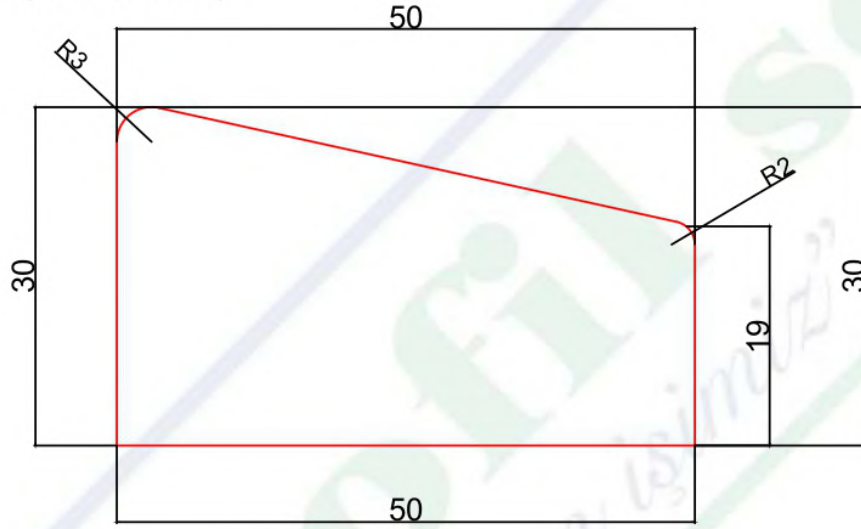

PVC BİTİŞ YERİ
(Pvc ending area)

BÖLÜM SORUMLUSU NEJDET ALTINTOPRAK	BU ÇİZİM PROFİLSE - SİLAS ORMAN ÜRÜNLERİ'NE AİTTİR. İZINSİZ ÇOĞALTILMAMAK VE KOPYA EDİLMEK ŞARTI İLE İZİN VERİLMİŞTİR.	PVC ENİ : MDF MİKTARI : PLAKADAN ÇIKAN :	KSM ÖLÇÜCÜ :	KUTU İÇİ : KUTU İÇİ ADET :
ARGE SORUMLUSU DOĞUKAN DEMİR	THIS DRAWING PROFILE - SİLAS FOREST PRODUCTS WHAT TO DO. UNLOCKED AND COPY NOT ALLOWED WITH THE WRITTEN.	GENEL TOLERANS : PROFL BOY TOLERANSI :	MATERİYAL MM MDF	TARİH / DATE 10.04.2019

30 mm Profiles

PROFİLSE - SİLAS ORMAN ÜRÜNLERİ

KAĞIT ÜZERİNDEN ÖLÇÜ ALMAYINIZ !!!
Don't measure on paper.

ÜRÜN KODU : 30*18

(Product Code)

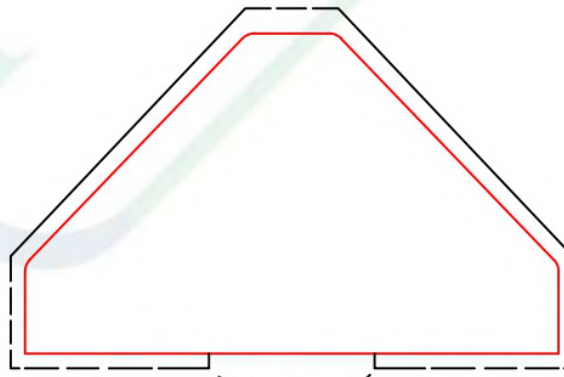
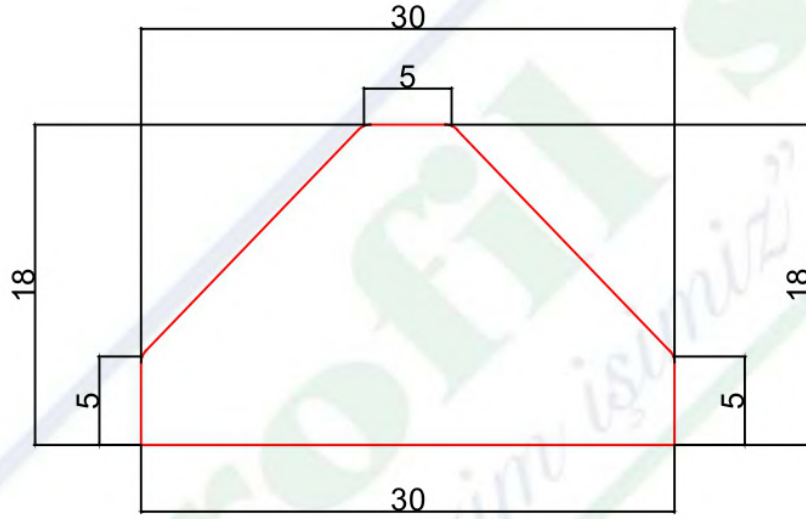

PVC BİTİŞ YERİ
(Pvc ending area)

BÖLÜM SORUMLUSU NEJDET ALTINTOPRAK	BU ÇİZİM PROFİLSE - SİLAS ORMAN ÜRÜNLERİ'NE AİTTİR. İZINSİZ ÇOĞALTILMAMAK VE KOPYA EDİLMEMEK ŞARTI İLE İZİN VERİLMİŞTİR.	PVC ENİ : MDF MİKTARI : PLAKADAN ÇIKAN :	KSM ÖLÇÜCÜ :	KUTU İÇİ : KUTU İÇİ ADET :
ARGE SORUMLUSU DOĞUKAN DEMİR	THIS DRAWING PROFILE - SILAS FOREST PRODUCTS WHAT TO DO. UNLOCKED AND COPY NOT ALLOWED WITH THE WRITTEN.	GENEL TOLERANS : PROFİL BOY TOLERANSI :	MATERIAL MM MDF	TARİH / DATE 16.04.2019

30 mm Profiles

PROFİLSE - SİLAS ORMAN ÜRÜNLERİ

KAĞIT ÜZERİNDEN ÖLÇÜ ALMAYINIZ !!!
Don't measurate on paper.

ÜRÜN KODU : 30*35

(Product Code)

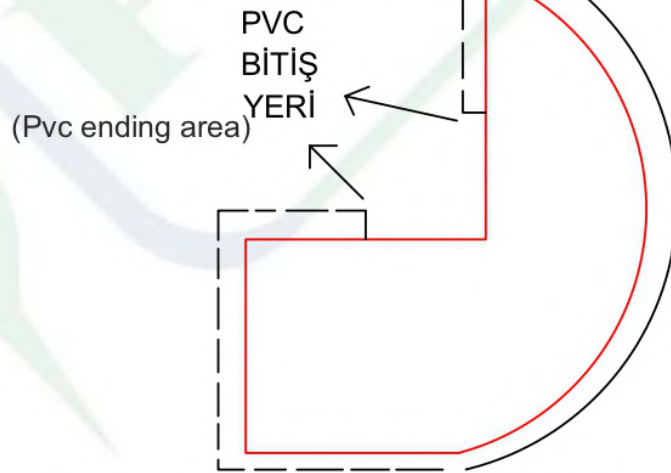
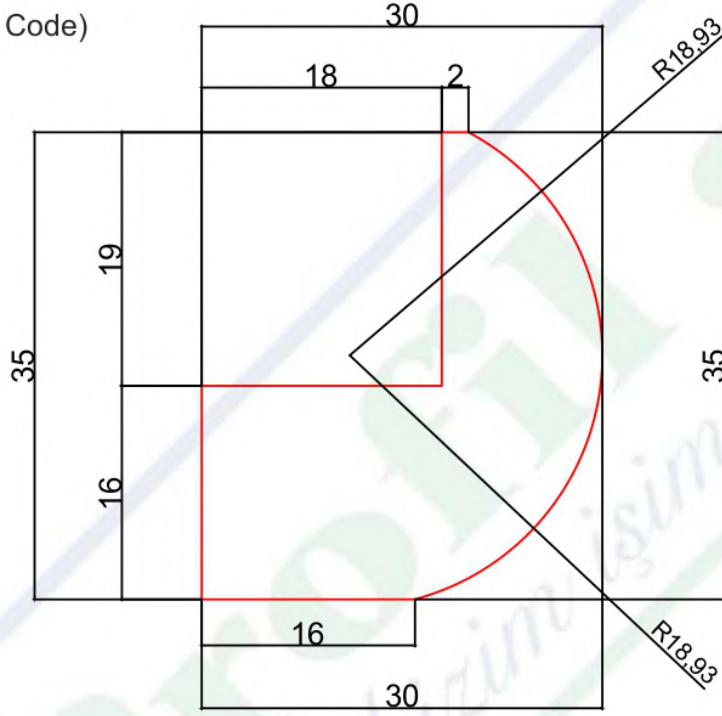

BÖLÜM SORUMLUSU NEJDET ALTINTOPRAK	BU ÇİZİM PROFİLSE - SİLAS ORMAN ÜRÜNLERİ'NE AİTTİR. İZINSİZ ÇOĞALTILMAMAK VE KOPYA EDİLMEKEMEK ŞARTI İLE İZİN VERİLMİŞTİR.	PVC ENİ : MDF MİKTARI : PLAKADAN ÇIKAN :	KSM ÖLÇÜCÜ :	KUTU İÇİ : KUTU İÇİ ADET :
ARGE SORUMLUSU DOĞUKAN DEMİR	THIS DRAWING PROFILE - SİLAS FOREST PRODUCTS WHAT TO DO. UNLOCKED AND COPY NOT ALLOWED WITH THE WRITTEN.	GENEL TOLERANS : PROFİL BOY TOLERANSI :	MATERİYAL MM MDF	TARİH / DATE 16.04.2019

30 mm Profiles

PROFİLSE - SİLAS ORMAN ÜRÜNLERİ

KAĞIT ÜZERİNDEN ÖLÇÜ ALMAYINIZ !!!
Don't measure on paper.

ÜRÜN KODU : 30*80
(Product Code)

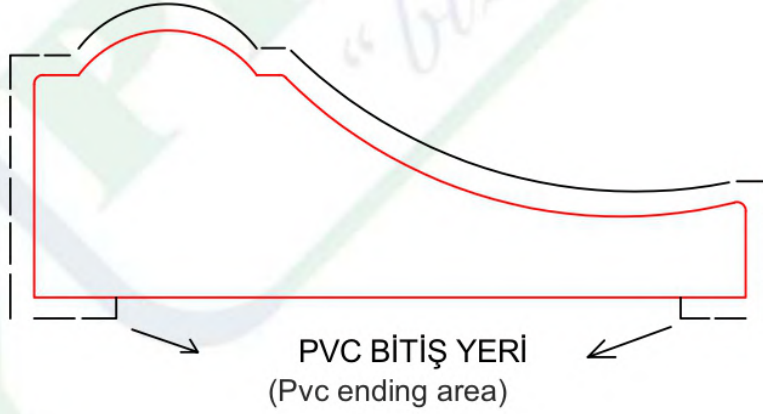
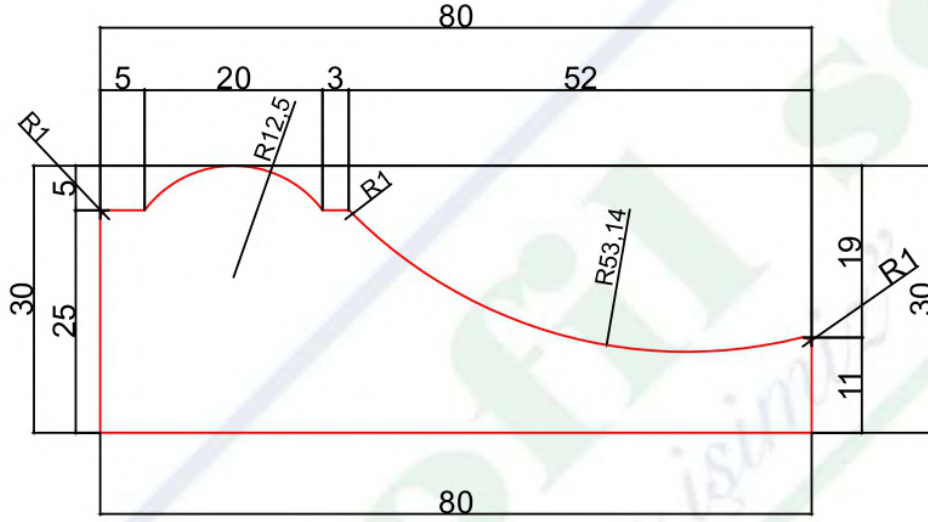

BÖLÜM SORUMLUSU NEJDET ALTINTOPRAK	BU ÇİZİM PROFİLSE - SİLAS ORMAN ÜRÜNLERİ'NE AİTTİR. İZINSİZ ÇOĞALTILMAMAK VE KOPYA EDİLMEMEK ŞARTI İLE İZİN VERİLMİŞTİR.	PVC ENİ : MDF MİKTARI : PLAKADAN ÇIKAN :	KSM ÖLÇÜCÜ :	KUTU İÇİ : KUTU İÇİ ADET :
ARGE SORUMLUSU DOĞUKAN DEMİR	THIS DRAWING PROFILE - SİLAS FOREST PRODUCTS WHAT TO DO. UNLOCKED AND COPY NOT ALLOWED WITH THE WRITTEN.	GENEL TOLERANS : PROFİL BOY TOLERANSI :	MATERIAL MM MDF	TARİH / DATE 20.05.2019

30 mm Profiles

PROFİLSE - SİLAS ORMAN ÜRÜNLERİ

KAĞIT ÜZERİNDEN ÖLÇÜ ALMAYINIZ !!!
Don't measure on paper.

ÜRÜN KODU : 30*80 KANALLI
(Product Code)

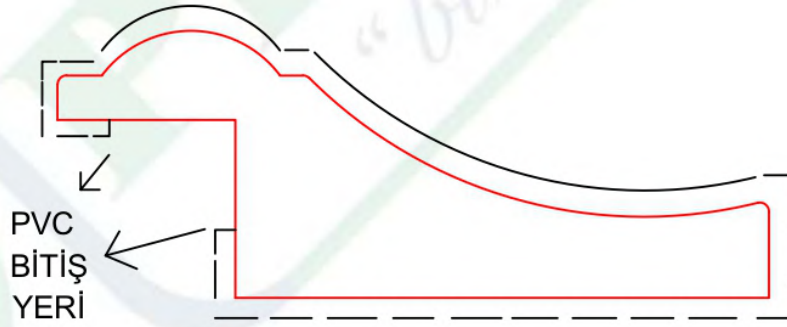
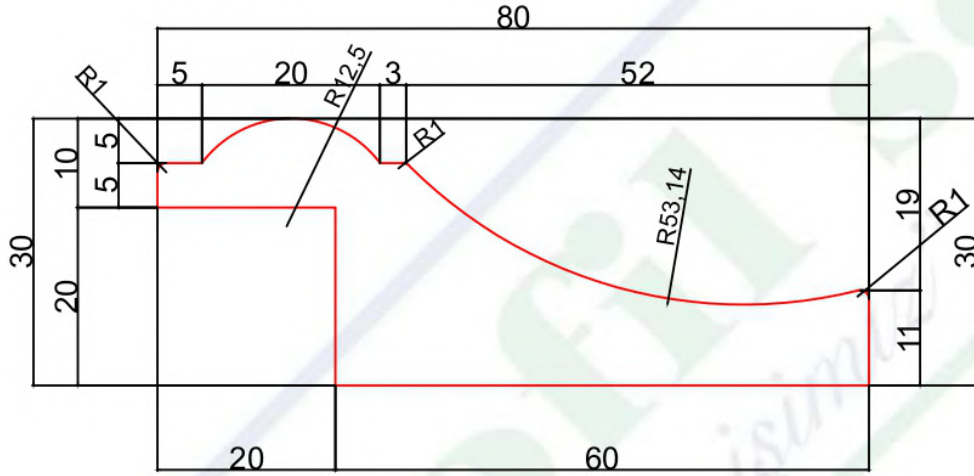

(Pvc ending area)

BÖLÜM SORUMLUSU NEJDET ALTINTOPRAK	BU ÇİZİM PROFİLSE - SİLAS ORMAN ÜRÜNLERİ'NE AİTTİR. İZINSİZ ÇOĞALTILMAMAK VE KOPYA EDİLMEMEK ŞARTI İLE İZİN VERİLMİŞTİR.	PVC ENİ : MDF MİKTARI : PLAKADAN ÇIKAN :	KSM ÖLÇÜCÜ :	KUTU İÇİ : KUTU İÇİ ADET :
ARGE SORUMLUSU DOĞUKAN DEMİR	THIS DRAWING PROFILE - SİLAS FOREST PRODUCTS WHAT TO DO. UNLOCKED AND COPY NOT ALLOWED WITH THE WRITTEN.	GENEL TOLERANS : PROFİL BOY TOLERANSI :	MATERİYAL MM MDF	TARİH / DATE 20.05.2019

30 mm Profiles

PROFİLSE - SİLAS ORMAN ÜRÜNLERİ

KAĞIT ÜZERİNDEN ÖLÇÜ ALMAYINIZ !!!
Don't measure on paper.

ÜRÜN KODU : 30*36-14
(Product Code)

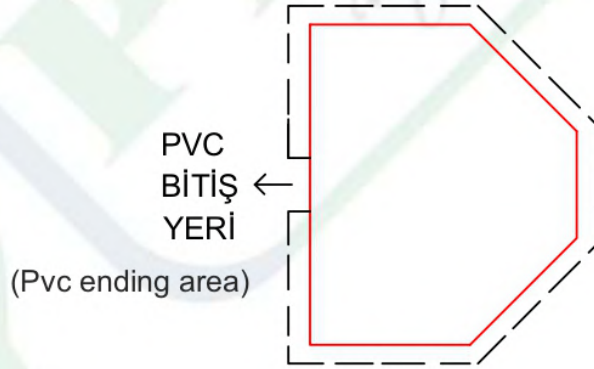
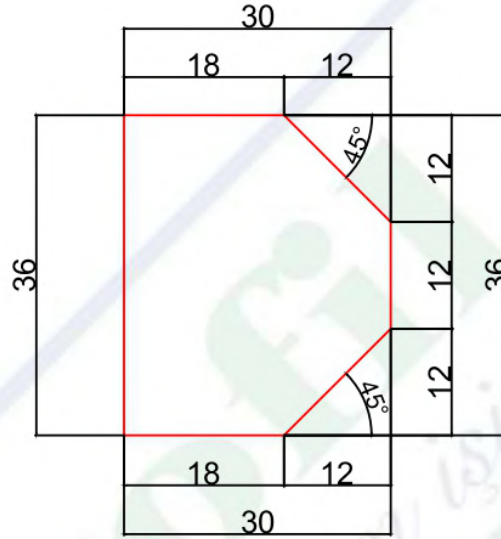

BÖLÜM SORUMLUSU NEJDET ALTINTOPRAK	BU ÇİZİM PROFİLSE - SİLAS ORMAN ÜRÜNLERİ'NE AİTTİR. İZINSİZ ÇOĞALTILMAMAK VE KOPYA EDİLMEKEMEK ŞARTI İLE İZİN VERİLMİŞTİR.	PVC ENİ : MDF MİKTARI : PLAKADAN ÇIKAN :	KSM ÖLÇÜCÜ :	KUTU İÇİ : KUTU İÇİ ADET :
ARGE SORUMLUSU DOĞUKAN DEMİR	THIS DRAWING PROFILE - SİLAS FOREST PRODUCTS WHAT TO DO. UNLOCKED AND COPY NOT ALLOWED WITH THE WRITTEN.	GENEL TOLERANS : PROFİL BOY TOLERANSI :	MATERİYAL MM MDF	TARİH / DATE 18.01.2019

30 mm Profiles

PROFİLSE - SİLAS ORMAN ÜRÜNLERİ

KAĞIT ÜZERİNDEN ÖLÇÜ ALMAYINIZ !!!

Don't measurate on paper.

ÜRÜN KODU : 30*44
(Product Code)

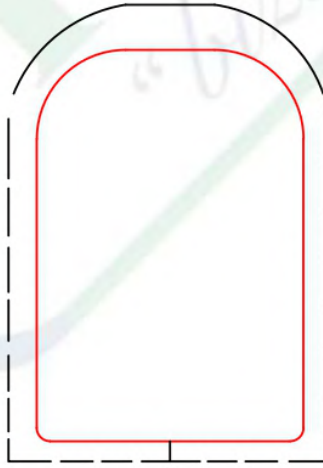
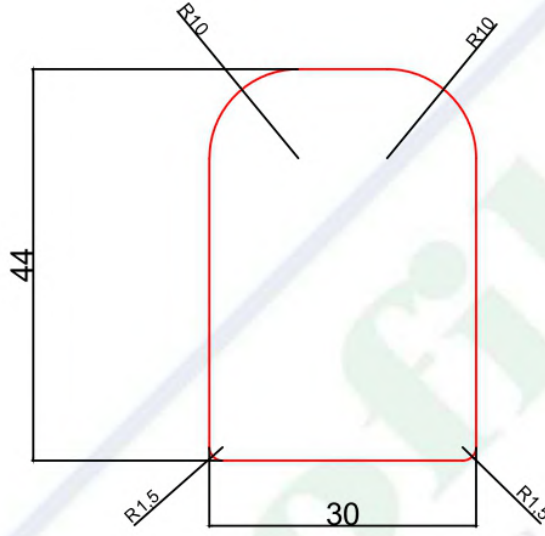

PVC BİTİŞ YERİ
(Pvc ending area)

BÖLÜM SORUMLUSU NEJDET ALTINTOPRAK	BU ÇİZİM PROFİLSE - SİLAS ORMAN ÜRÜNLERİ'NE AİTTİR. İZINSİZ ÇOĞALTILMAMAK VE KOPYA EDİLMEMEK ŞARTI İLE İZİN VERİLMİŞTİR.	PVC ENİ : MDF MİKTARI : PLAKADAN ÇIKAN :	KSM ÖLÇÜCÜ :	KUTU İÇİ : KUTU İÇİ ADET :
ARGE SORUMLUSU DOĞUKAN DEMİR	THIS DRAWING PROFILE - SİLAS FOREST PRODUCTS WHAT TO DO. UNLOCKED AND COPY NOT ALLOWED WITH THE WRITTEN.	GENEL TOLERANS : PROFL BOY TOLERANSI :	MATERİAL MM MDF	TARİH / DATE 10.12.2018

30 mm Profiles

PROFİLSE - SİLAS ORMAN ÜRÜNLERİ

KAĞIT ÜZERİNDEN ÖLÇÜ ALMAYINIZ !!!

Don't measurate on paper.

ÜRÜN KODU : 30*50
(Product Code)

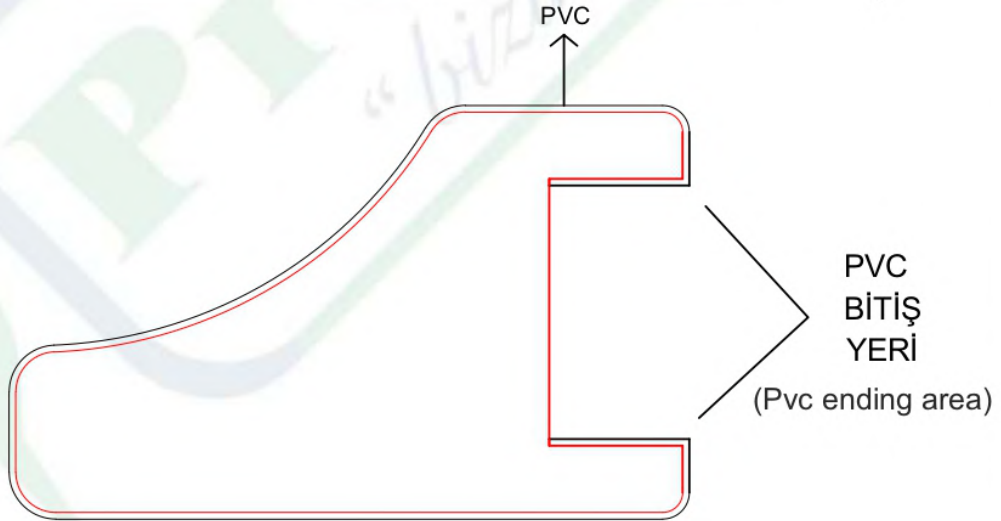
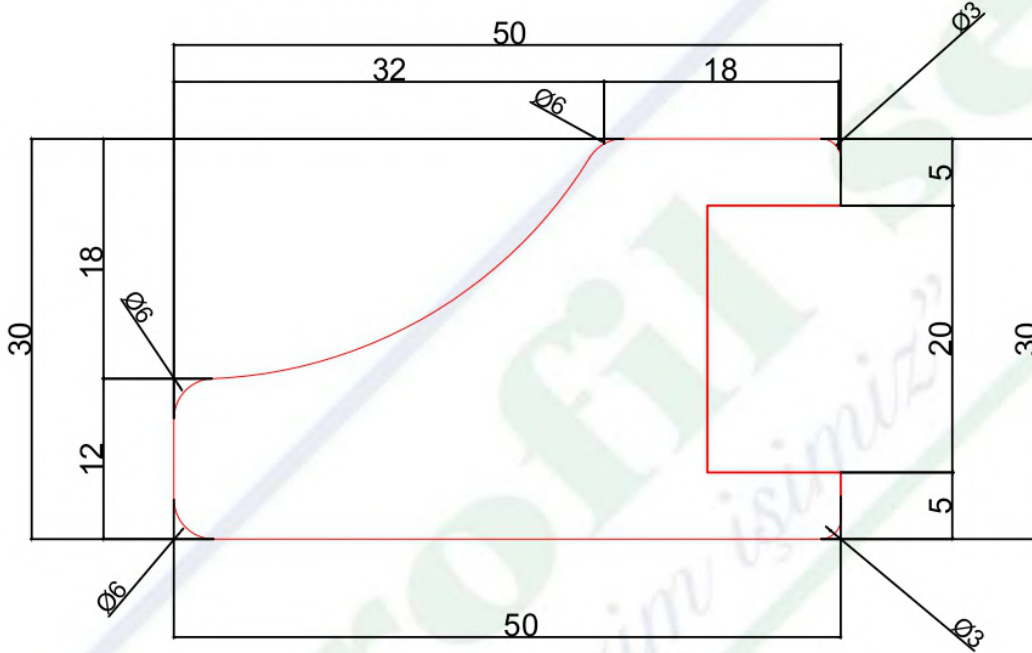

BÖLÜM SORUMLUSU NEJDET ALTINTOPRAK	BU ÇİZİM PROFİLSE - SİLAS ORMAN ÜRÜNLERİ'NE AİTTİR. İZINSİZ ÇOĞALTILMAMAK VE KOPYA EDİLMEMEK ŞARTI İLE İZİN VERİLMİŞTİR.	PVC ENİ : MDF MİKTARI : PLAKADAN ÇIKAN :	KSM ÖLÇÜCÜ :	KUTU İÇİ : KUTU İÇİ ADET :
ARGE SORUMLUSU DOĞUKAN DEMİR	THIS DRAWING PROFILE - SİLAS FOREST PRODUCTS WHAT TO DO. UNLOCKED AND COPY NOT ALLOWED WITH THE WRITTEN.	GENEL TOLERANS : PROFİL BOY TOLERANSI :	MATERİYAL MM MDF	TARİH / DATE 16.01.2019

30 mm Profiles

PROFİLSE - SİLAS ORMAN ÜRÜNLERİ

KAĞIT ÜZERİNDEN ÖLÇÜ ALMAYINIZ !!!

Don't measurate on paper.

ÜRÜN KODU : 315(30*75)

(Product Code)

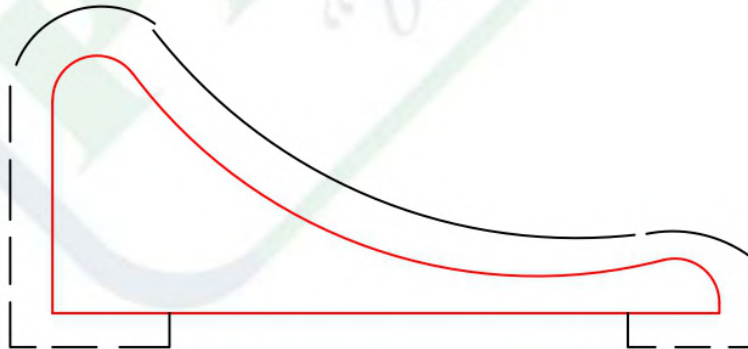
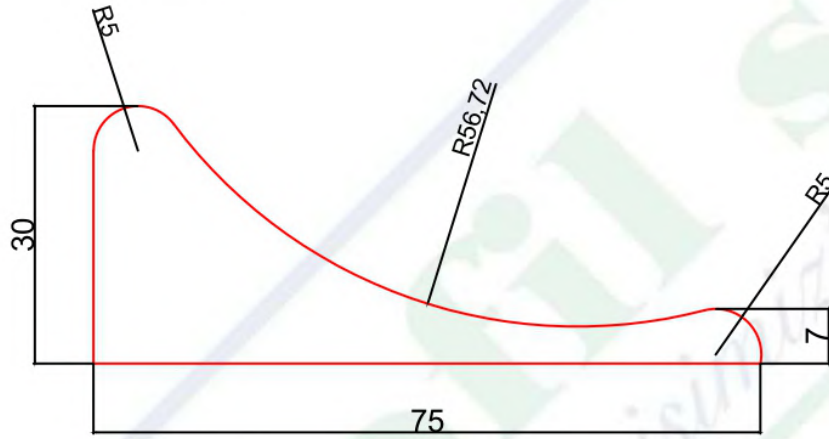

PVC BİTİŞ YERİ

(Pvc ending area)

BÖLÜM SORUMLUSU NEJDET ALTINTOPRAK	BU ÇİZİM PROFİLSE - SİLAS ORMAN ÜRÜNLERİ'NE AİTTİR. İZİNSİZ ÇOĞALTILMAMAK VE KOPYA EDİLMEMEK ŞARTI İLE İZİN VERİLMİŞTİR.	PVC ENİ : MDF MİKTARI : PLAKADAN ÇIKAN :	KSM ÖLÇÜCÜ :	KUTU İÇİ : KUTU İÇİ ADET :
ARGE SORUMLUSU DOĞUKAN DEMİR	THIS DRAWING PROFILE - SİLAS FOREST PRODUCTS WHAT TO DO. UNLOCKED AND COPY NOT ALLOWED WITH THE WRITTEN.	GENEL TOLERANS : PROFL BOY TOLERANSI :	MATERİYAL MM MDF	TARİH / DATE 2.01.2019

30 mm Profiles

PROFİLSE - SİLAS ORMAN ÜRÜNLERİ

KAĞIT ÜZERİNDEN ÖLÇÜ ALMAYINIZ !!!

(Product Code)

Don't measure on paper.

ÜRÜN KODU : 30*37

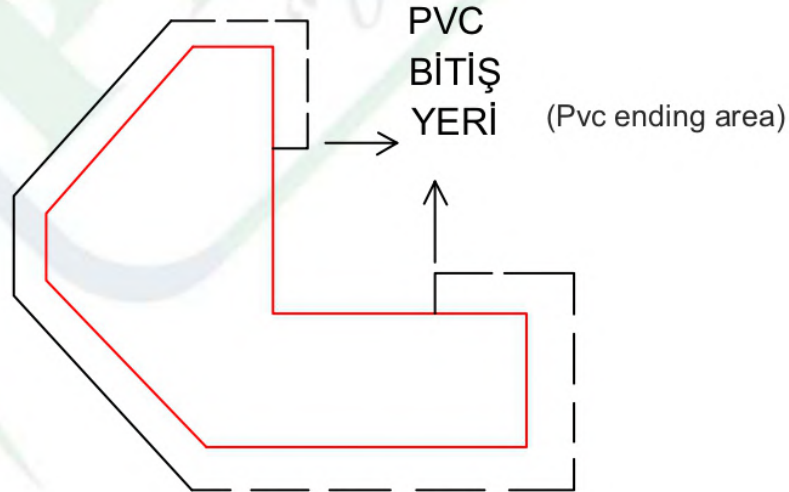
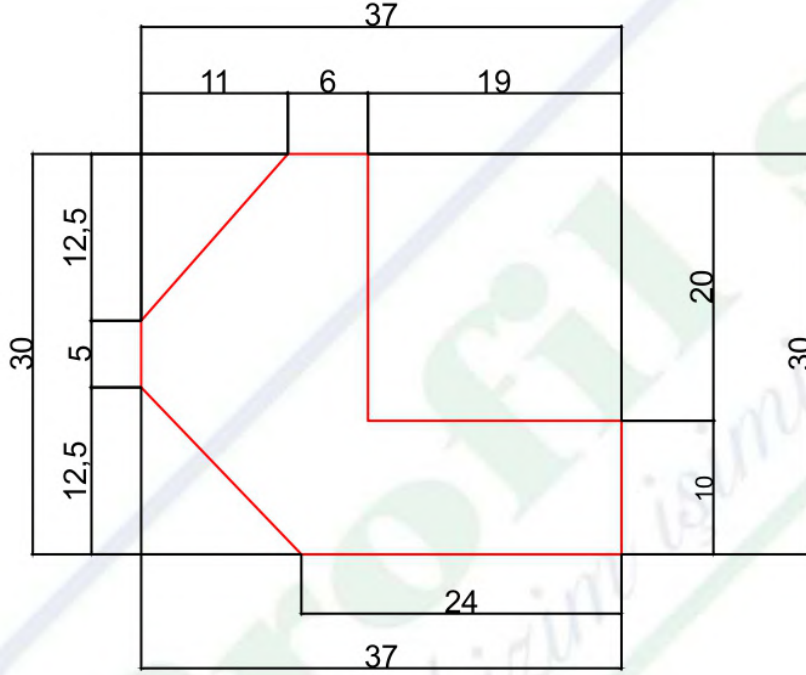

BÖLÜM SORUMLUSU NEJDET ALTINTOPRAK	BU ÇİZİM PROFİLSE - SİLAS ORMAN ÜRÜNLERİ'NE AİTTİR. İZİNSİZ ÇOĞALTILMAMAK VE KOPYA EDİLMEYEMEK ŞARTI İLE İZİN VERİLMİŞTİR.	PVC ENİ : MDF MİKTARI : PLAKADAN ÇIKAN :	KSM ÖLÇÜCÜ :	KUTU İÇİ : KUTU İÇİ ADET :
ARGE SORUMLUSU DOĞUKAN DEMİR	THIS DRAWING PROFILE - SİLAS FOREST PRODUCTS WHAT TO DO. UNLOCKED AND COPY NOT ALLOWED WITH THE WRITTEN.	GENEL TOLERANS : PROFİL BOY TOLERANSI :	MATERIAL MM MDF	TARİH / DATE 01.03.2019

30 mm Profiles

PROFİLSE - SİLAS ORMAN ÜRÜNLERİ

KAĞIT ÜZERİNDEN ÖLÇÜ ALMAYINIZ !!!

Don't measure on paper.

ÜRÜN KODU : 30*74

(Product Code)

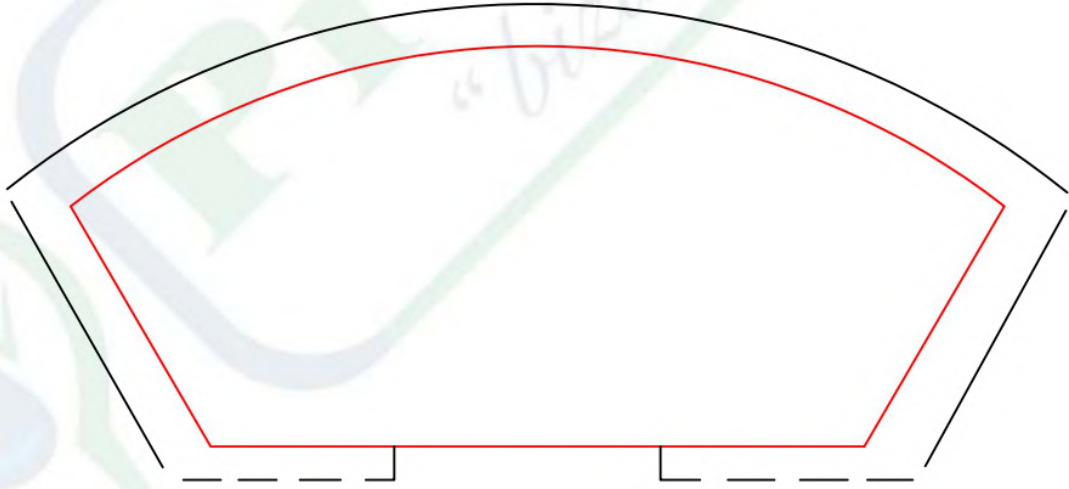
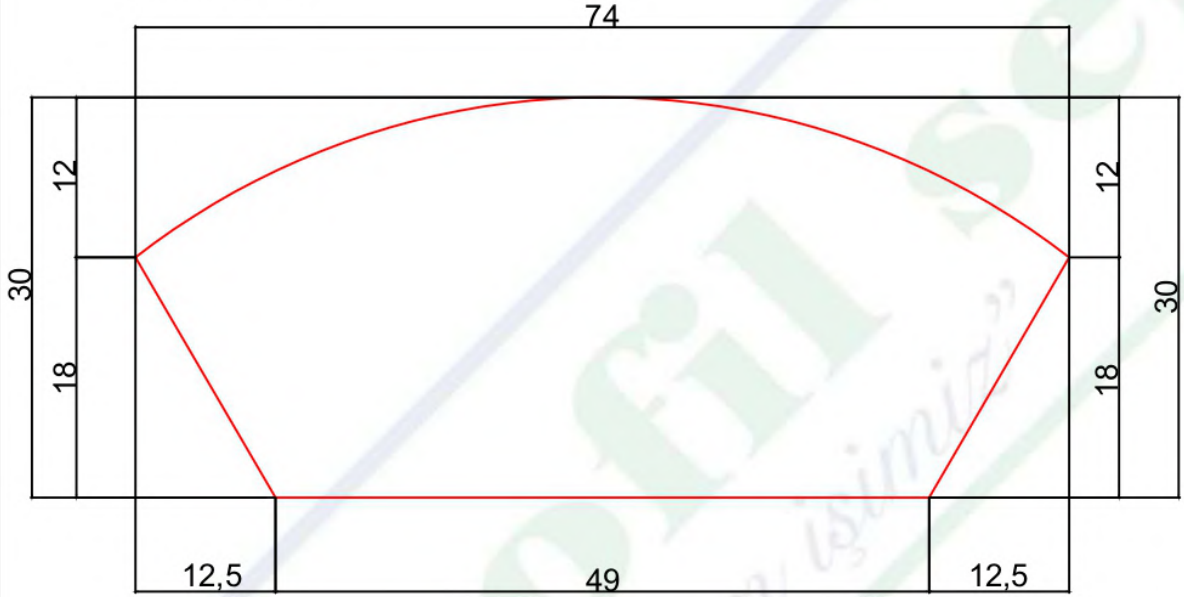

PVC BİTİŞ YERİ (Pvc ending area)

BÖLÜM SORUMLUSU NEJDET ALTINTOPRAK	BU ÇİZİM PROFİLSE - SİLAS ORMAN ÜRÜNLERİ'NE AİTTİR. İZİNSİZ ÇOĞALTILMAMAK VE KOPYA EDİLMEK ŞARTI İLE İZİN VERİLMİŞTİR.	PVC ENİ : MDF MİKTARI : PLAKADAN ÇIKAN :	KSM ÖLÇÜCÜ :	KUTU İÇİ : KUTU İÇİ ADET :
ARGE SORUMLUSU DOĞUKAN DEMİR	THIS DRAWING PROFILE - SİLAS FOREST PRODUCTS WHAT TO DO. UNLOCKED AND COPY NOT ALLOWED WITH THE WRITTEN.	GENEL TOLERANS : PROFİL BOY TOLERANSI :	MATERİYAL MM MDF	TARİH / DATE 12.11.2018

30 mm Profiles

PROFİLSE - SİLAS ORMAN ÜRÜNLERİ

KAĞIT ÜZERİNDEN ÖLÇÜ ALMAYINIZ !!!
Don't measure on paper.

ÜRÜN KODU 30*72
(Product Code)

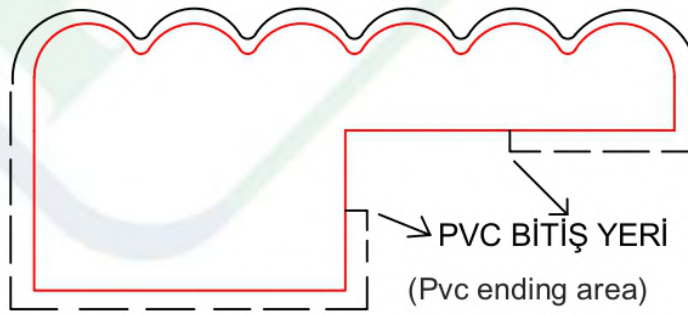
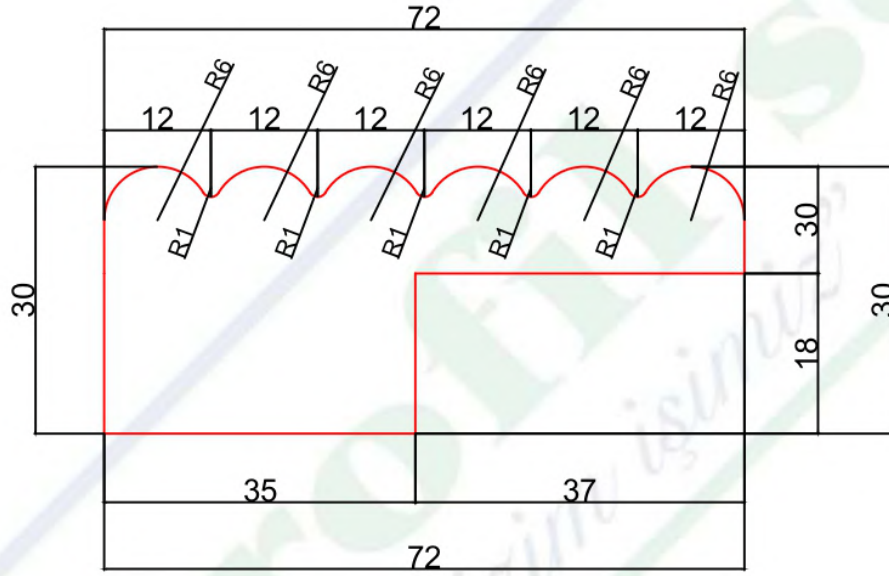

BÖLÜM SORUMLUSU NEJDET ALTINTOPRAK	BU ÇİZİM PROFİLSE - SİLAS ORMAN ÜRÜNLERİ'NE AITTİR. İZINSİZ ÇOĞALTILMAMAK VE KOPYA EDİLMEKEMEK ŞARTI İLE İZİN VERİLMİŞTİR.	PVC ENİ : MDF MİKTARI : PLAKADAN ÇIKAN :	KSM ÖLÇÜCÜ :	KUTU İÇİ : KUTU İÇİ ADET :
ARGE SORUMLUSU DOĞUKAN DEMİR	THIS DRAWING PROFILE - SİLAS FOREST PRODUCTS WHAT TO DO. UNLOCKED AND COPY NOT ALLOWED WITH THE WRITTEN.	GENEL TOLERANS : PROFİL BOY TOLERANSI :	MATERİYAL : MM MDF	TARİH / DATE 30.01.2019

30 mm Profiles

PROFİLSE - SİLAS ORMAN ÜRÜNLERİ

KAĞIT ÜZERİNDEN ÖLÇÜ ALMAYINIZ !!!
Don't measure on paper.

ÜRÜN KODU : 30-75(311 AL)

(Product Code)

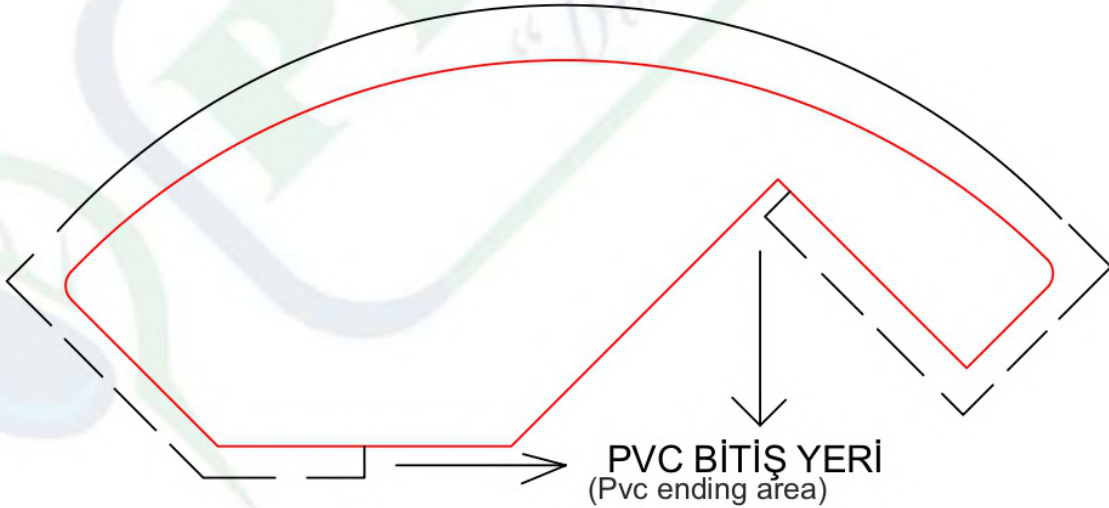
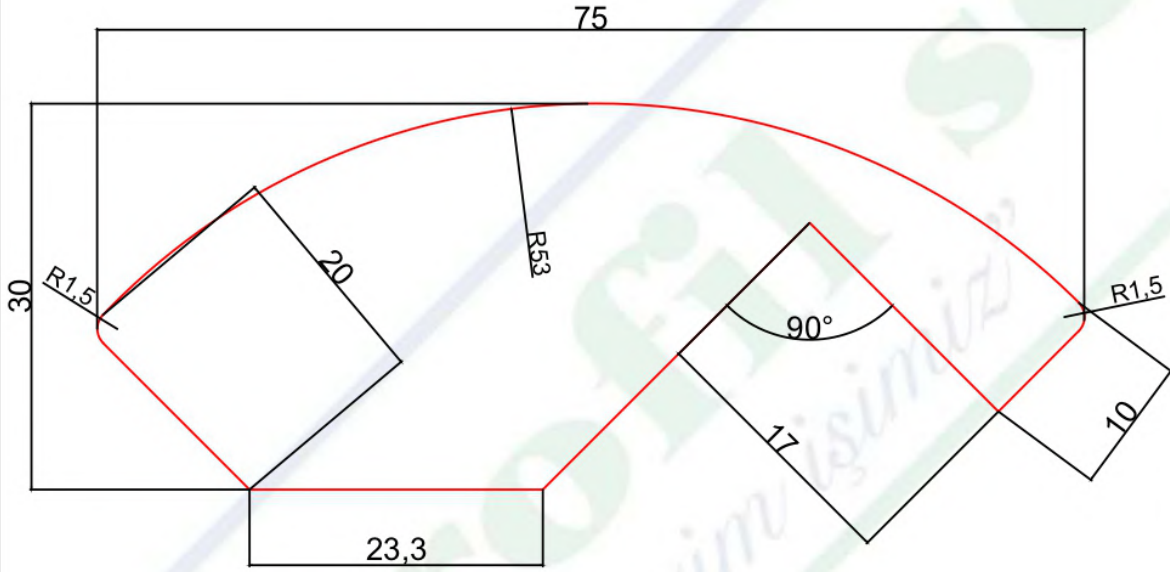

BÖLÜM SORUMLUSU NEJDET ALTINTOPRAK	BU ÇİZİM PROFİLSE - SİLAS ORMAN ÜRÜNLERİ'NE AİTTİR. İZINSİZ ÇOĞALTILMAMAK VE KOPYA EDİLMEMEK ŞARTI İLE İZİN VERİLMİŞTİR.	PVC ENİ : MDF MİKTARI : PLAKADAN ÇIKAN :	KSM ÖLÇÜCÜ :	KUTU İÇİ : KUTU İÇİ ADET :
ARGE SORUMLUSU DOĞUKAN DEMİR	THIS DRAWING PROFILE - SİLAS FOREST PRODUCTS WHAT TO DO. UNLOCKED AND COPY NOT ALLOWED WITH THE WRITTEN.	GENEL TOLERANS : PROFİL BOY TOLERANSI :	MATERIAL MM MDF	TARİH / DATE 07.02.2019

30 mm Profiles

PROFİLSE - SİLAS ORMAN ÜRÜNLERİ

KAĞIT ÜZERİNDEN ÖLÇÜ ALMAYINIZ !!!
Don't measure on paper.

ÜRÜN KODU : 30*130
(Product Code)

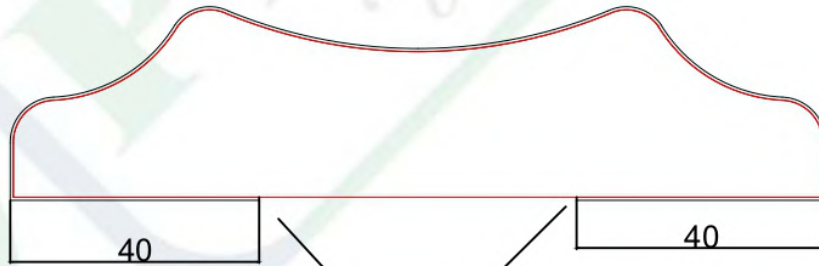
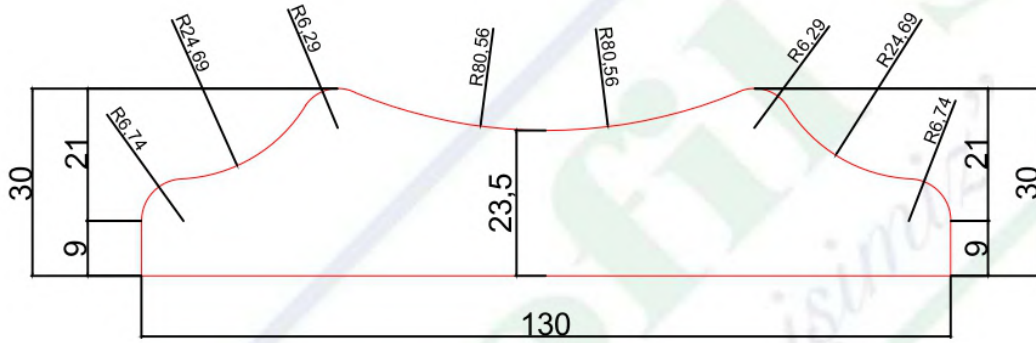

PVC BİTİŞ YERİ

(Pvc ending area)

BÖLÜM SORUMLUSU NEJDET ALTINTOPRAK	BU ÇİZİM PROFİLSE - SİLAS ORMAN ÜRÜNLERİ'NE AİTTİR. İZINSİZ ÇOĞALTILMAMAK VE KOPYA EDİLMEMEK ŞARTI İLE İZİN VERİLMİŞTİR.	PVC ENİ : MDF MİKTARI : PLAKADAN ÇIKAN :	KSM ÖLÇÜCÜ :	KUTU İÇİ : KUTU İÇİ ADET :
ARGE SORUMLUSU DOĞUKAN DEMİR	THIS DRAWING PROFILE - SILAS FOREST PRODUCTS WHAT TO DO. UNLOCKED AND COPY NOT ALLOWED WITH THE WRITTEN.	GENEL TOLERANS : PROFL BOY TOLERANSI :	MATERİYAL MM MDF	TARİH / DATE 16.01.2019

30 mm Profiles

PROFİLSE - SİLAS ORMAN ÜRÜNLERİ

ÜRÜN KODU : 31*40

(Product Code)

KAĞIT ÜZERİNDEN ÖLÇÜ ALMAYINIZ !!!

Don't measurate on paper.

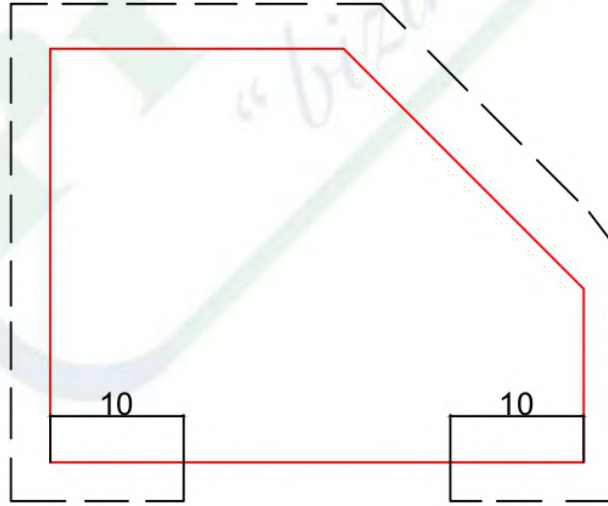
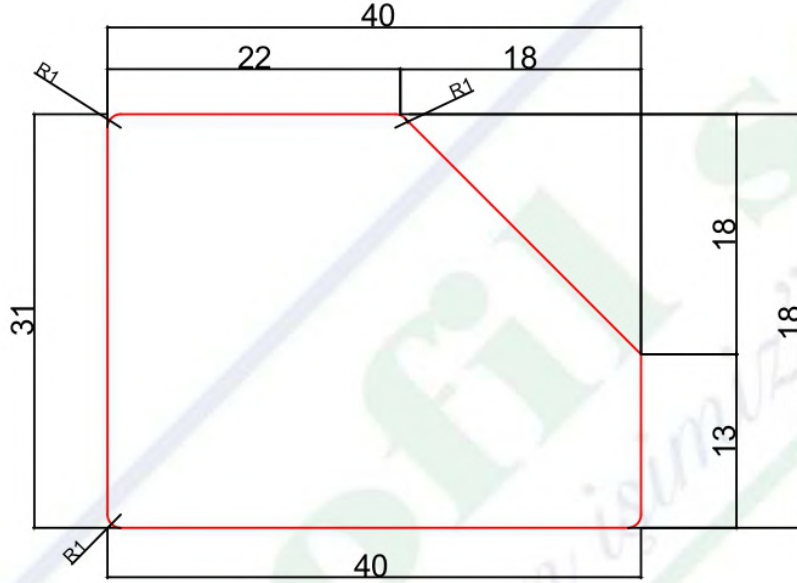

PVC BİTİŞ YERİ (Pvc ending area)

BÖLÜM SORUMLUSU NEJDET ALTINTOPRAK	BU ÇİZİM PROFİLSE - SİLAS ORMAN ÜRÜNLERİ'NE AİTTİR. İZINSİZ ÇOĞALTILMAMAK VE KOPYA EDİLMEMEK ŞARTI İLE İZİN VERİLMİŞTİR.	PVC ENİ : MDF MİKTARI : PLAKADAN ÇIKAN :	KSM ÖLÇÜCÜ :	KUTU İÇİ : KUTU İÇİ ADET :
ARGE SORUMLUSU DOĞUKAN DEMİR	THIS DRAWING PROFILE - SİLAS FOREST PRODUCTS WHAT TO DO. UNLOCKED AND COPY NOT ALLOWED WITH THE WRITTEN.	GENEL TOLERANS : PROFL BOY TOLERANSI :	MATERIAL MM MDF	TARİH / DATE 10.12.2018

36 mm Profiles

PROFİLSE - SİLAS ORMAN ÜRÜNLERİ

KAĞIT ÜZERİNDEN ÖLÇÜ ALMAYINIZ !!!

ÜRÜN KODU : 35*70

(Product Code)

Don't measurate on paper.

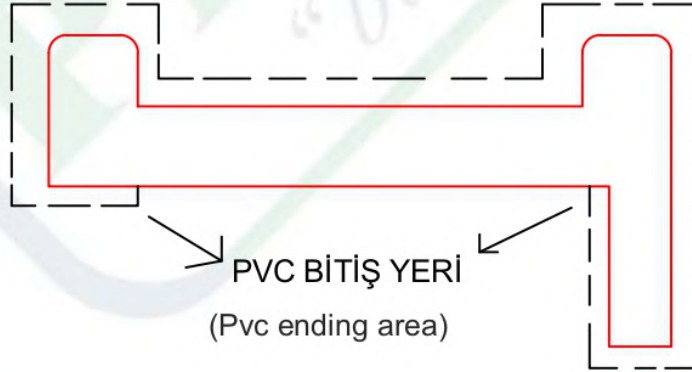
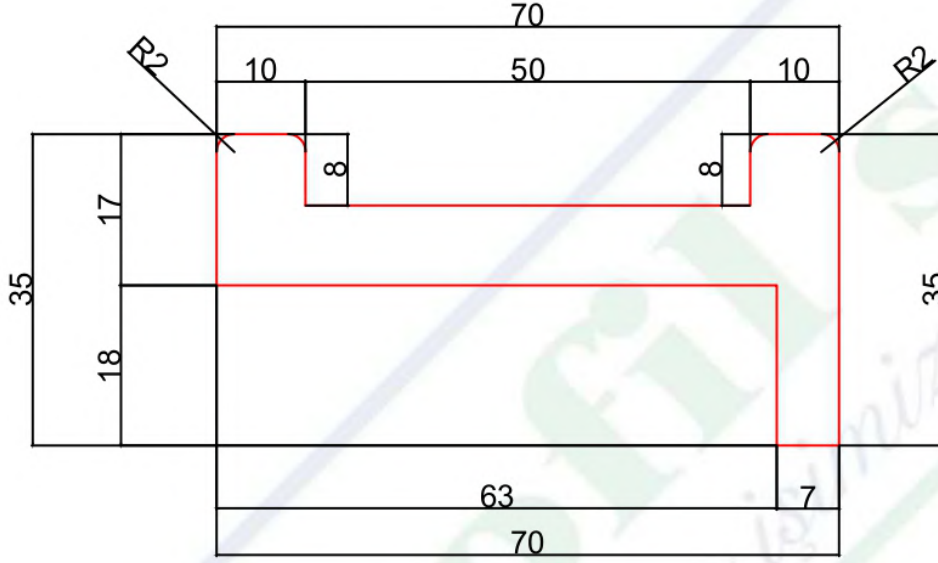

BÖLÜM SORUMLUSU NEJDET ALTINTOPRAK	BU ÇİZİM PROFİLSE - SİLAS ORMAN ÜRÜNLERİ'NE AİTTİR. İZİNSİZ ÇOĞALTILMAMAK VE KOPYA EDİLMEKEMEK ŞARTI İLE İZİN VERİLMİŞTİR.	PVC ENİ : MDF MİKTARI : PLAKADAN ÇIKAN :	KSM ÖLÇÜCÜ :	KUTU İÇİ : KUTU İÇİ ADET :
ARGE SORUMLUSU DOĞUKAN DEMİR	THIS DRAWING PROFILE - SİLAS FOREST PRODUCTS WHAT TO DO. UNLOCKED AND COPY NOT ALLOWED WITH THE WRITTEN.	GENEL TOLERANS : PROFL BOY TOLERANSI :	MATERİYAL MM MDF	TARİH / DATE 10.10.2018

36 mm Profiles

PROFİLSE - SİLAS ORMAN ÜRÜNLERİ

KAĞIT ÜZERİNDEN ÖLÇÜ ALMAYINIZ !!!
Don't measure on paper.

ÜRÜN KODU : 36*60
(Product Code)

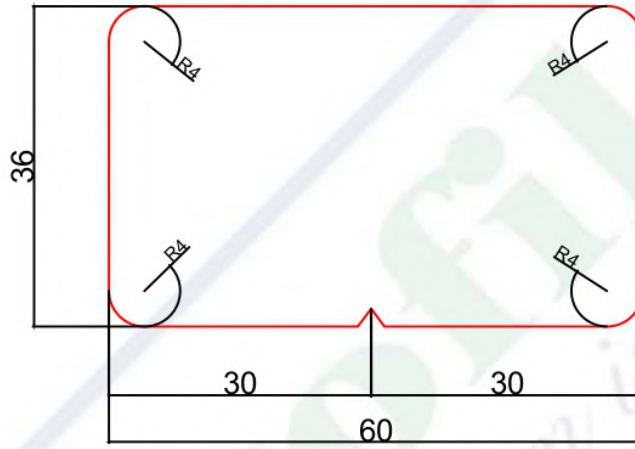

PVC BİTİŞ YERİ
(Pvc ending area)

BÖLÜM SORUMLUSU NEJDET ALTINTOPRAK	BU ÇİZİM PROFİLSE - SİLAS ORMAN ÜRÜNLERİ'NE AİTTİR. İZINSİZ ÇOĞALTILMAMAK VE KOPYA EDİLMEMEK ŞARTI İLE İZİN VERİLMİŞTİR.	PVC ENİ : MDF MİKTARI : PLAKADAN ÇIKAN :	KSM ÖLÇÜCÜ :	KUTU İÇİ : KUTU İÇİ ADET :
ARGE SORUMLUSU DOĞUKAN DEMİR	THIS DRAWING PROFILE - SİLAS FOREST PRODUCTS WHAT TO DO. UNLOCKED AND COPY NOT ALLOWED WITH THE WRITTEN.	GENEL TOLERANS : PROFİL BOY TOLERANSI :	MATERİYAL MM MDF	TARİH / DATE 10.12.2018

36 mm Profiles

PROFİLSE - SİLAS ORMAN ÜRÜNLERİ

KAĞIT ÜZERİNDEN ÖLÇÜ ALMAYINIZ !!!

Don't measure on paper.

ÜRÜN KODU : 36*80

(Product Code)

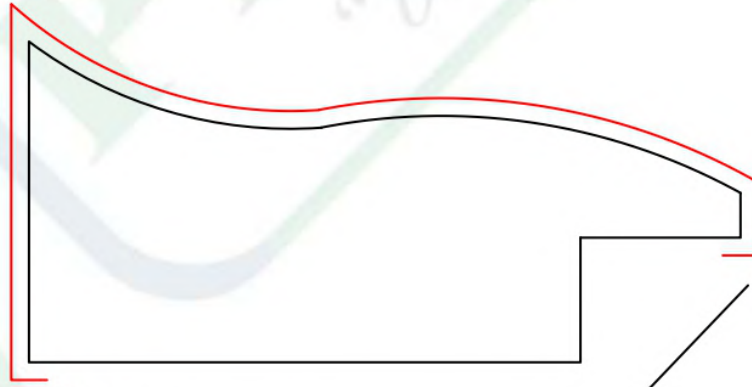
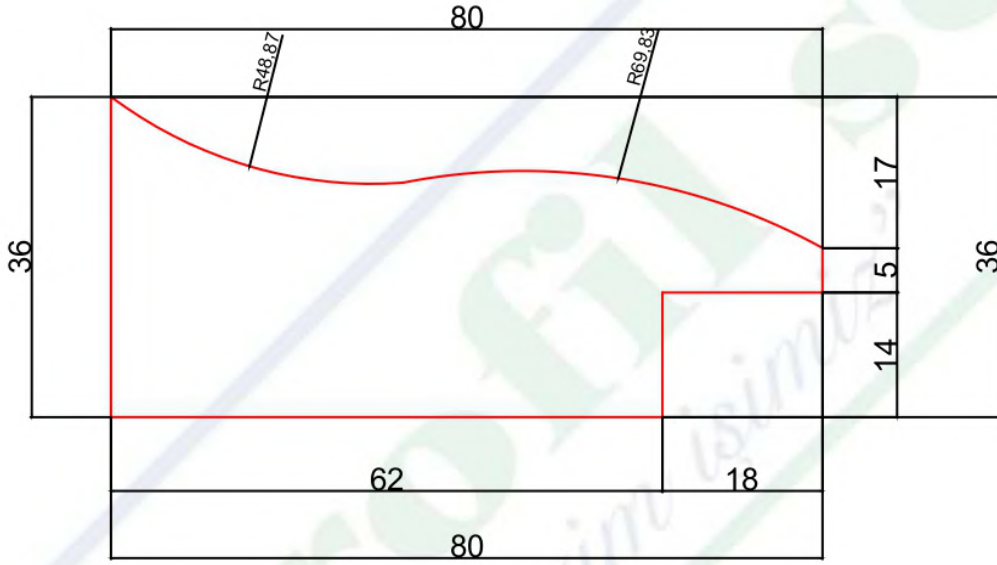

PVC BİTİŞ YERİ
(Pvc ending area)

BÖLÜM SORUMLUSU NEJDET ALTINTOPRAK	BU ÇİZİM PROFİLSE - SİLAS ORMAN ÜRÜNLERİ'NE AİTTİR. İZİNSİZ ÇOĞALTILMAMAK VE KOPYA EDİLMEMEK ŞARTI İLE İZİN VERİLMİŞTİR.	PVC ENİ : MDF MİKTARI : PLAKADAN ÇIKAN :	KSM ÖLÇÜCÜ :	KUTU İÇİ : KUTU İÇİ ADET :
ARGE SORUMLUSU DOĞUKAN DEMİR	THIS DRAWING PROFILE - SİLAS FOREST PRODUCTS WHAT TO DO. UNLOCKED AND COPY NOT ALLOWED WITH THE WRITTEN.	GENEL TOLERANS : PROFL BOY TOLERANSI :	MATERIAL MM MDF	TARİH / DATE 19.02.2019

36 mm Profiles

PROFİLSE - SİLAS ORMAN ÜRÜNLERİ

ÜRÜN KODU : 36*124
(Product Code)

KAĞIT ÜZERİNDEN ÖLÇÜ ALMAYINIZ !!!
Don't measure on paper.

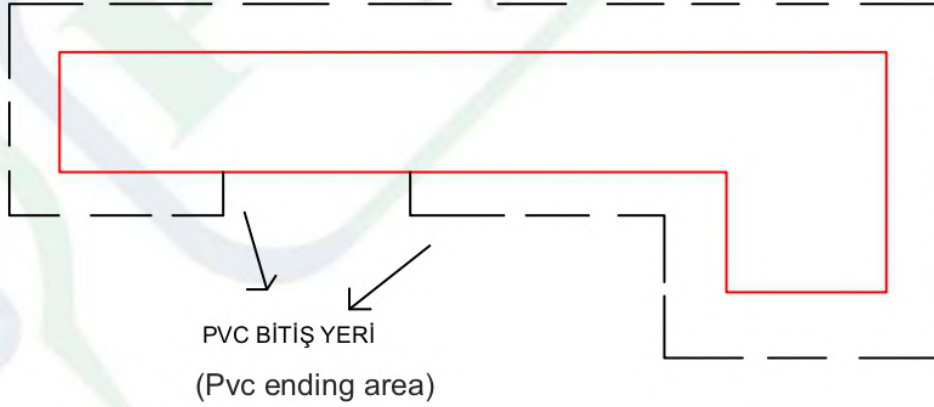

BÖLÜM SORUMLUSU NEJDET ALTINTOPRAK	BU ÇİZİM PROFİLSE - SİLAS ORMAN ÜRÜNLERİ'NE AİTTİR. İZINSİZ ÇOĞALTILMAMAK VE KOPYA EDİLMEKEMEK ŞARTI İLE İZİN VERİLMİŞTİR.	PVC ENİ : MDF MİKTARI : PLAKADAN ÇIKAN :	KSM ÖLÇÜCÜ :	KUTU İÇİ : KUTU İÇİ ADET :
ARGE SORUMLUSU DOĞUKAN DEMİR	THIS DRAWING PROFILE - SİLAS FOREST PRODUCTS WHAT TO DO. UNLOCKED AND COPY NOT ALLOWED WITH THE WRITTEN.	GENEL TOLERANS : PROFİL BOY TOLERANSI :	MATERİYAL MM MDF	TARİH / DATE 04.10.2018

36 mm Profiles

PROFİLSE - SİLAS ORMAN ÜRÜNLERİ

KAĞIT ÜZERİNDEN ÖLÇÜ ALMAYINIZ !!!
Don't measure on paper.

ÜRÜN KODU : 36*60
(Product Code)

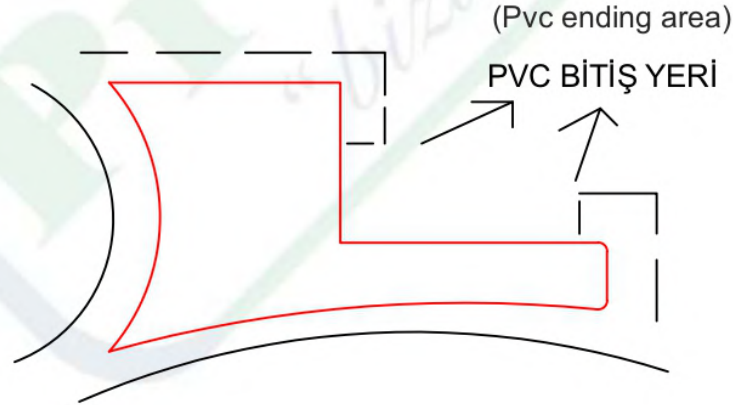
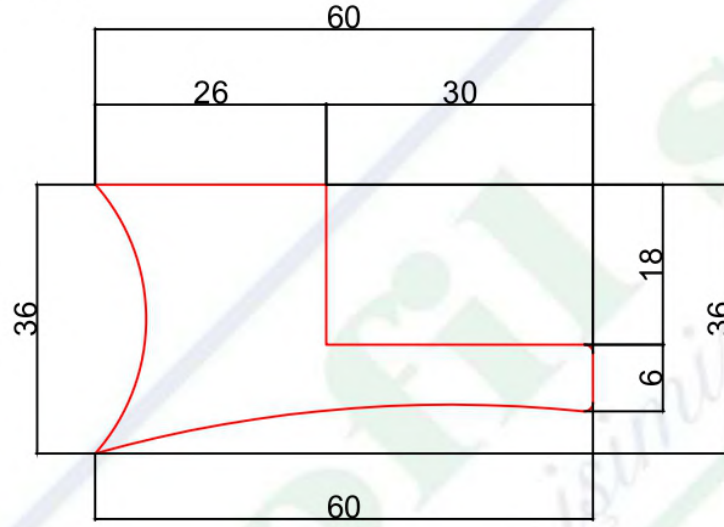

BÖLÜM SORUMLUSU NEJDET ALTINTOPRAK	BU ÇİZİM PROFİLSE - SİLAS ORMAN ÜRÜNLERİ'NE AİTTİR. İZİNSİZ ÇOĞALTILMAMAK VE KOPYA EDİLMEMEK ŞARTI İLE İZİN VERİLMİŞTİR.	PVC ENİ : MDF MIKTARI : PLAKADAN ÇIKAN :	KSM ÖLÇÜCÜ :	KUTU İÇİ : KUTU İÇİ ADET :
ARGE SORUMLUSU DOĞUKAN DEMİR	THIS DRAWING PROFILE - SİLAS FOREST PRODUCTS WHAT TO DO. UNLOCKED AND COPY NOT ALLOWED WITH THE WRITTEN.	GENEL TOLERANS : PROFİL BOY TOLERANSI :	MATERIAL MM MDF	TARİH / DATE 04.10.2018

36 mm Profiles

PROFİLSE - SİLAS ORMAN ÜRÜNLERİ

KAĞIT ÜZERİNDEN ÖLÇÜ ALMAYINIZ !!!
Don't measure on paper.

ÜRÜN KODU : 37*66
(Product Code)

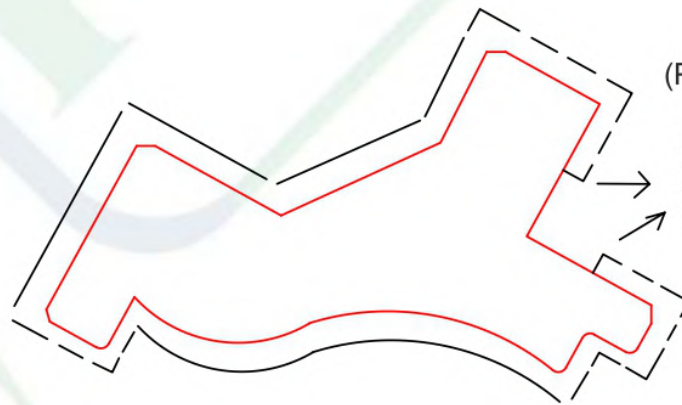
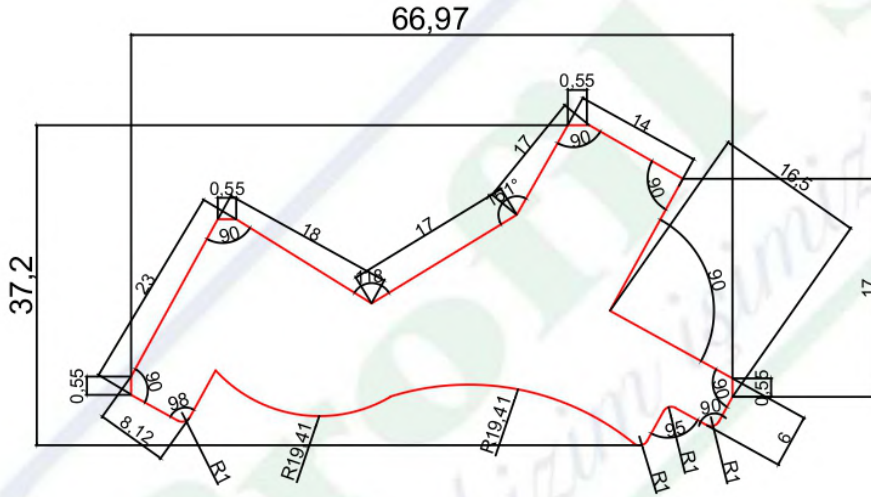

(Pvc ending area)

PVC
BİTİŞ
YERİ

BÖLÜM SORUMLUSU NEJDET ALTINTOPRAK	BU ÇİZİM PROFİLSE - SİLAS ORMAN ÜRÜNLERİ'NE AİTTİR. İZİNSİZ ÇOĞALTILMAMAK VE KOPYA EDİLMEKEMEK ŞARTI İLE İZİN VERİLMİŞTİR.	PVC ENİ : MDF MİKTARI : PLAKADAN ÇIKAN :	KSM ÖLÇÜCÜ :	KUTU İÇİ : KUTU İÇİ ADET :
ARGE SORUMLUSU DOĞUKAN DEMİR	THIS DRAWING PROFILE - SİLAS FOREST PRODUCTS WHAT TO DO. UNLOCKED AND COPY NOT ALLOWED WITH THE WRITTEN.	GENEL TOLERANS : PROFİL BOY TOLERANSI :	MATERIAL MM MDF	TARİH / DATE 10.12.2018

36 mm Profiles

PROFİLSE - SİLAS ORMAN ÜRÜNLERİ

KAĞIT ÜZERİNDEN ÖLÇÜ ALMAYINIZ !!!

Don't measurate on paper.

ÜRÜN KODU : 36*43

(Product Code)

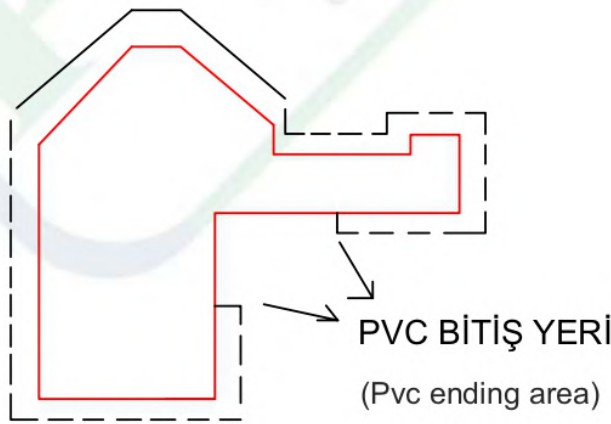
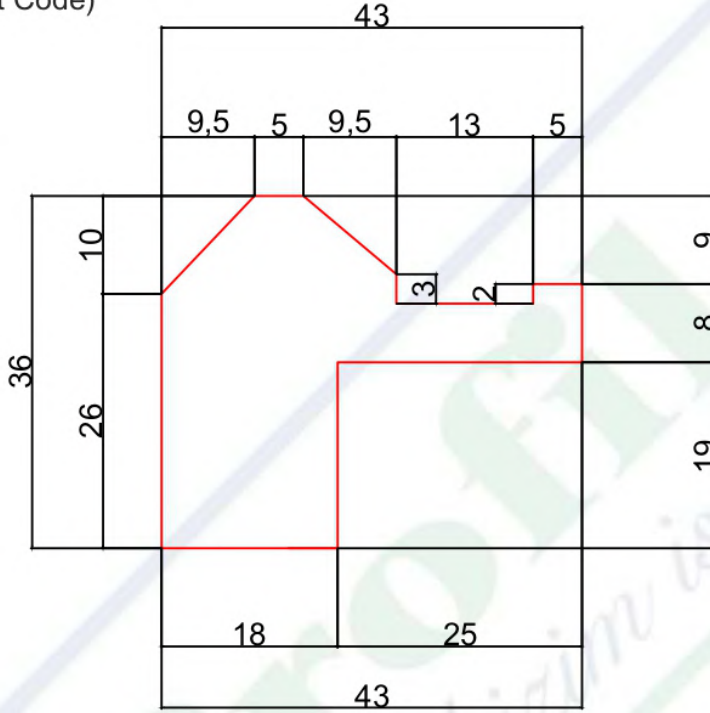

BÖLÜM SORUMLUSU NEJDET ALTINTOPRAK	BU ÇİZİM PROFİLSE - SİLAS ORMAN ÜRÜNLERİ'NE AITTİR. İZİNSİZ ÇOĞALTILMAMAK VE KOPYA EDİLMEMEK ŞARTI İLE İZİN VERİLMİŞTİR.	PVC ENİ : MDF MİKTARI : PLAKADAN ÇIKAN :	KSM ÖLÇÜCÜ :	KUTU İÇİ : KUTU İÇİ ADET :
ARGE SORUMLUSU DOĞUKAN DEMİR	THIS DRAWING PROFILE - SİLAS FOREST PRODUCTS WHAT TO DO. UNLOCKED AND COPY NOT ALLOWED WITH THE WRITTEN.	GENEL TOLERANS : PROFİL BOY TOLERANSI :	MATERİYAL MM MDF	TARİH / DATE 19.11.2018

36 mm Profiles

PROFİLSE - SİLAS ORMAN ÜRÜNLERİ

ÜRÜN KODU: 36*100
(Product Code)

KAĞIT ÜZERİNDEN ÖLÇÜ ALMAYINIZ !!!
Don't measure on paper.

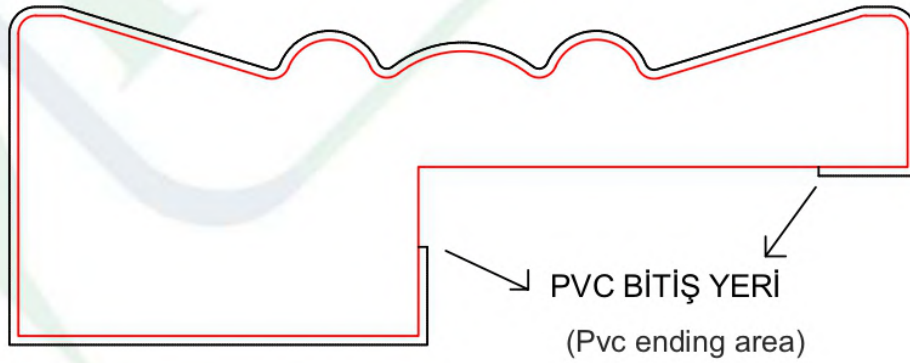
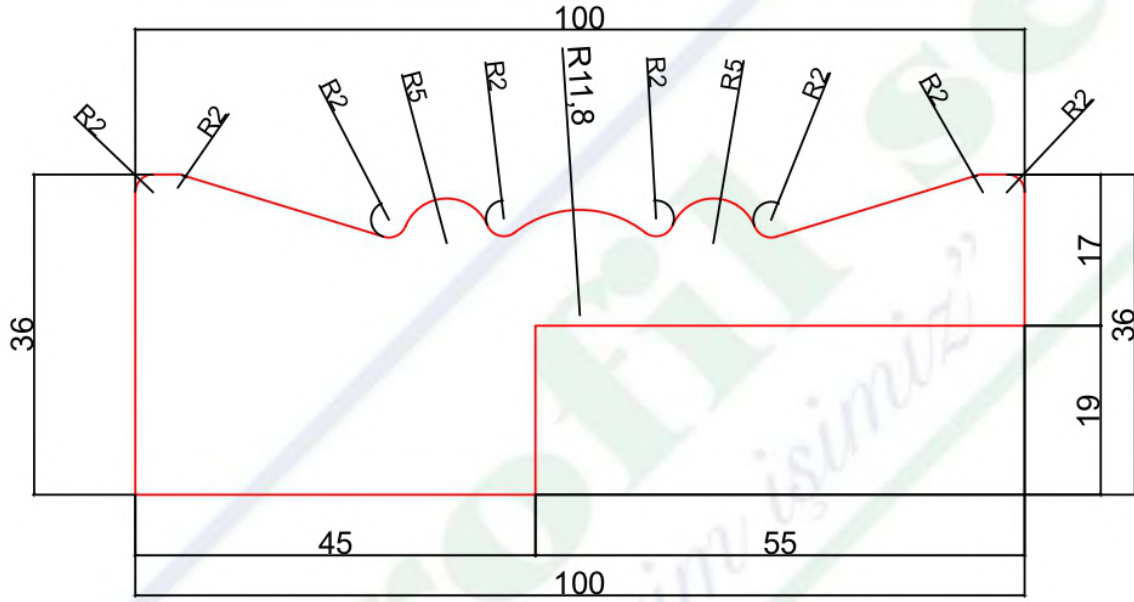

BÖLÜM SORUMLUSU NEJDET ALTINTOPRAK	BU ÇİZİM PROFİLSE - SİLAS ORMAN ÜRÜNLERİ'NE AİTTİR. İZINSİZ ÇOĞALTILMAMAK VE KOPYA EDİLMEMEK ŞARTI İLE İZİN VERİLMİŞTİR.	PVC ENİ : MDF MİKTARI : PLAKADAN ÇIKAN :	KSM ÖLÇÜCÜ :	KUTU İÇİ : KUTU İÇİ ADET :
ARGE SORUMLUSU DOĞUKAN DEMİR	THIS DRAWING PROFILE - SILAS FOREST PRODUCTS WHAT TO DO. UNLOCKED AND COPY NOT ALLOWED WITH THE WRITTEN.	GENEL TOLERANS : PROFİL BOY TOLERANSI :	MATERİYAL MM MDF	TARİH / DATE 20.12.2018

36 mm Profiles

PROFİLSE - SİLAS ORMAN ÜRÜNLERİ

KAĞIT ÜZERİNDEN ÖLÇÜ ALMAYINIZ !!!

ÜRÜN KODU : 313 (18+18*110)
(Product Code)

Don't measurate on paper.

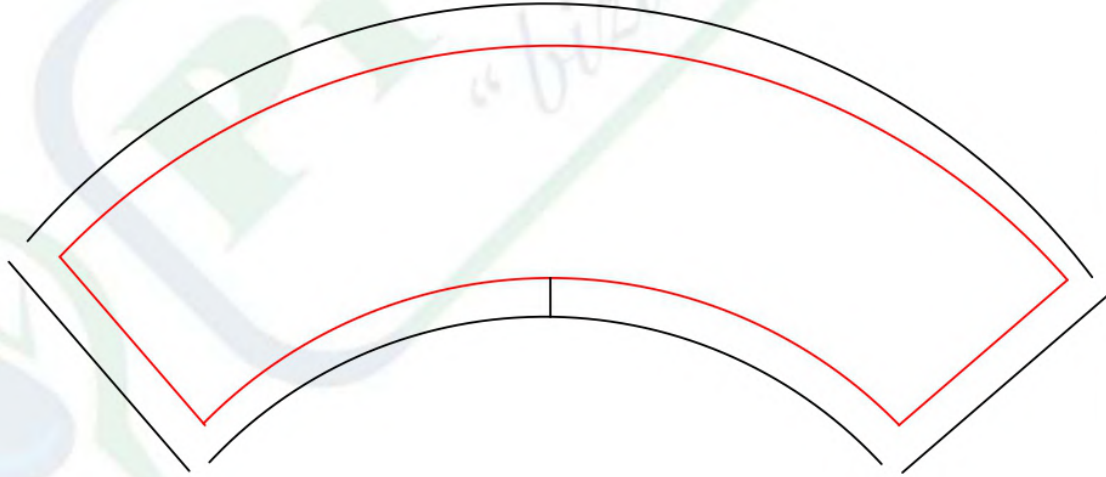
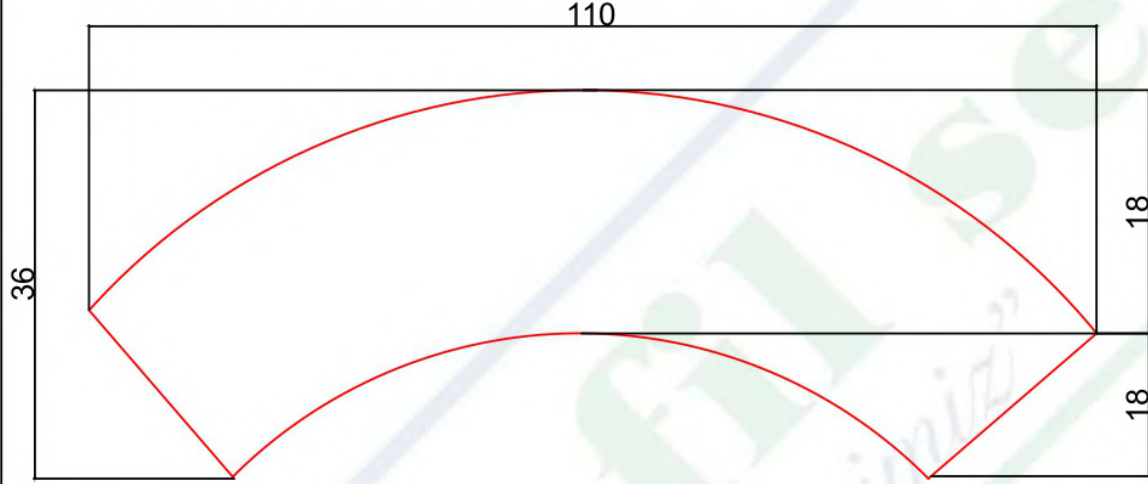

BÖLÜM SORUMLUSU NEJDET ALTINTOPRAK	BU ÇİZİM PROFİLSE - SİLAS ORMAN ÜRÜNLERİ'NE AİTTİR. İZINSİZ ÇOĞALTILMAMAK VE KOPYA EDİLMEKEMEK ŞARTI İLE İZİN VERİLMİŞTİR.	PVC ENİ : MDF MİKTARI : PLAKADAN ÇIKAN :	KSM ÖLÇÜCÜ :	KUTU İÇİ : KUTU İÇİ ADET :
ARGE SORUMLUSU DOĞUKAN DEMİR	THIS DRAWING PROFILE - SİLAS FOREST PRODUCTS WHAT TO DO. UNLOCKED AND COPY NOT ALLOWED WITH THE WRITTEN.	GENEL TOLERANS : PROFİL BOY TOLERANSI :	MATERİAL MM MDF	TARİH / DATE 14.11.2018

36 mm Profiles

PROFİLSE - SİLAS ORMAN ÜRÜNLERİ

KAĞIT ÜZERİNDEN ÖLÇÜ ALMAYINIZ !!!
Don't measure on paper.

ÜRÜN KODU : 36*90

(Product Code)

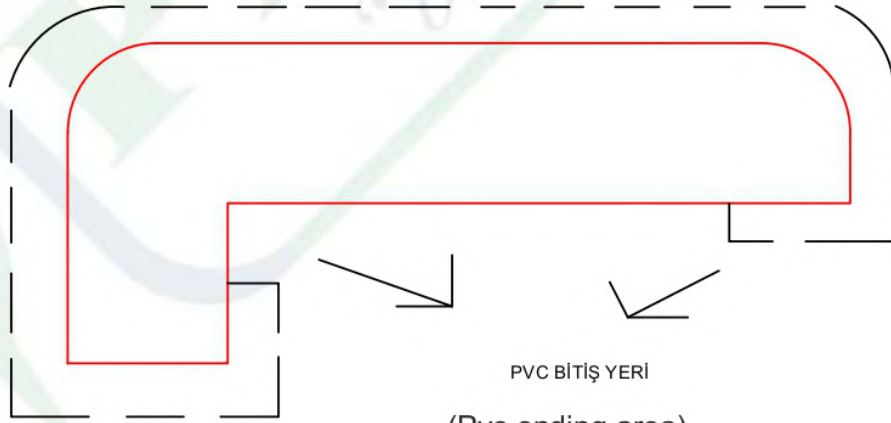
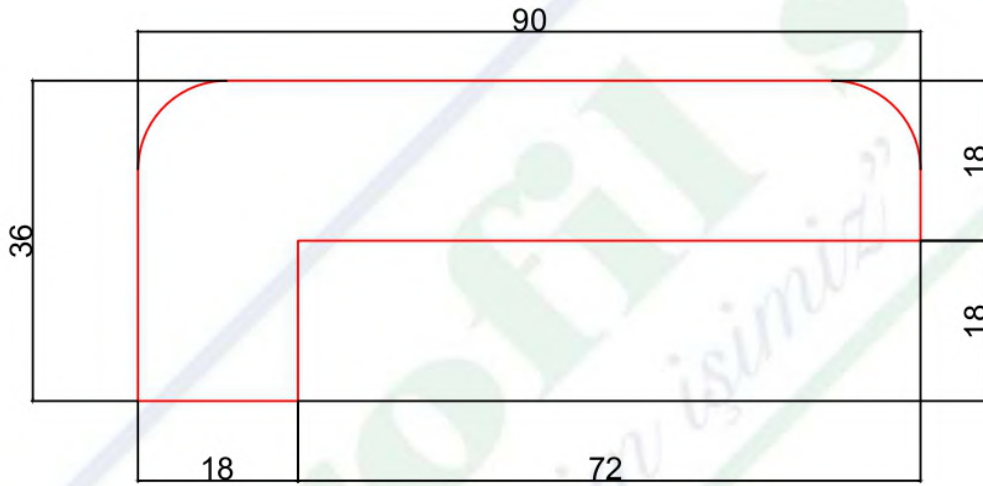

BÖLÜM SORUMLUSU NEJDET ALTINTOPRAK	BU ÇİZİM PROFİLSE - SİLAS ORMAN ÜRÜNLERİ'NE AİTTİR. İZINSİZ ÇOĞALTILMAMAK VE KOPYA EDİLMEMEK ŞARTI İLE İZİN VERİLMİŞTİR.	PVC ENİ : MDF MİKTARI : PLAKADAN ÇIKAN :	KSM ÖLÇÜCÜ :	KUTU İÇİ : KUTU İÇİ ADET :
ARGE SORUMLUSU DOĞUKAN DEMİR	THIS DRAWING PROFILE - SİLAS FOREST PRODUCTS WHAT TO DO. UNLOCKED AND COPY NOT ALLOWED WITH THE WRITTEN.	GENEL TOLERANS : PROFL BOY TOLERANSI :	MATERİYAL MM MDF	TARİH / DATE 04.10.2018

36 mm Profiles

PROFİLSE - SİLAS ORMAN ÜRÜNLERİ

KAĞIT ÜZERİNDEN ÖLÇÜ ALMAYINIZ !!!
Don't measure on paper.

ÜRÜN KODU : 36*88
(Product Code)

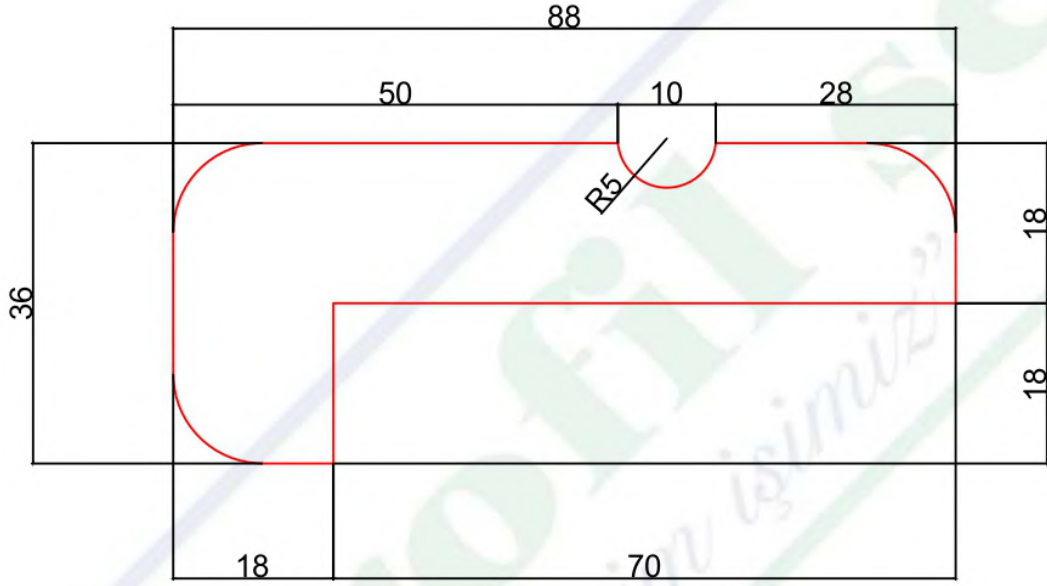

PVC BİTİŞ YERİ
(Pvc ending area)

BÖLÜM SORUMLUSU NEJDET ALTINTOPRAK	BU ÇİZİM PROFİLSE - SİLAS ORMAN ÜRÜNLERİ'NE AİTTİR. İZINSİZ ÇOĞALTILMAMAK VE KOPYA EDİLMEMEK ŞARTI İLE İZİN VERİLMİŞTİR.	PVC ENİ : MDF MİKTARI : PLAKADAN ÇIKAN :	KSM ÖLÇÜCÜ :	KUTU İÇİ : KUTU İÇİ ADET :
ARGE SORUMLUSU DOĞUKAN DEMİR	THIS DRAWING PROFILE - SİLAS FOREST PRODUCTS WHAT TO DO. UNLOCKED AND COPY NOT ALLOWED WITH THE WRITTEN.	GENEL TOLERANS : PROFİL BOY TOLERANSI :	MATERİYAL MM MDF	TARİH / DATE 04.10.2018

36 mm Profiles

PROFİLSE - SİLAS ORMAN ÜRÜNLERİ

KAĞIT ÜZERİNDEN ÖLÇÜ ALMAYINIZ !!!

Don't measurate on paper.

ÜRÜN KODU : 36*80

(Product Code)

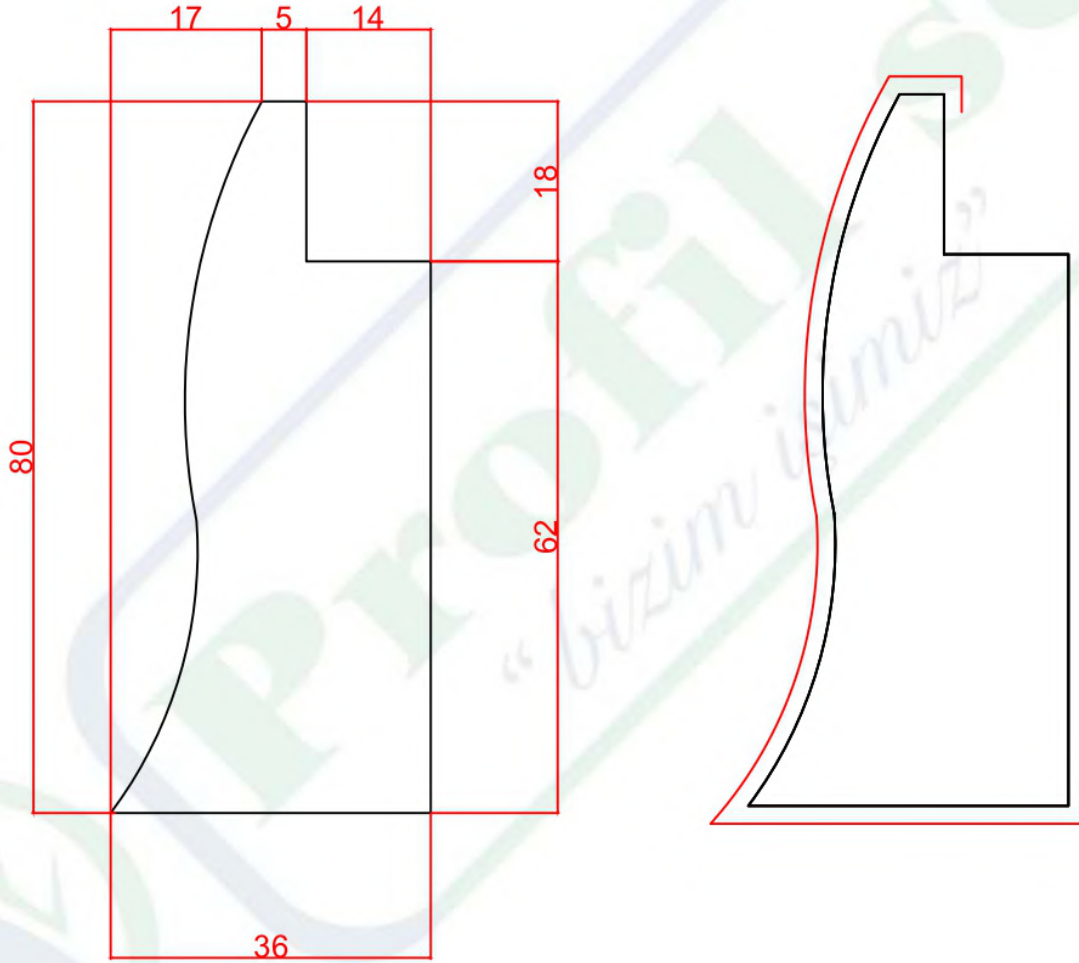

BÖLÜM SORUMLUSU NEJDET ALTINTOPRAK	BU ÇİZİM PROFİLSE - SİLAS ORMAN ÜRÜNLERİ'NE AITTIR. İZİNSİZ ÇOĞALTILMAMAK VE KOPYA EDİLMEMEK ŞARTI İLE İZİN VERİLMİŞTİR.	PVC ENİ : MDF MİKTARI : PLAKADAN ÇIKAN :	KSM ÖLÇÜCÜ :	KUTU İÇİ : KUTU İÇİ ADET :
ARGE SORUMLUSU DOĞUKAN DEMİR	THIS DRAWING PROFILE - SİLAS FOREST PRODUCTS WHAT TO DO. UNLOCKED AND COPY NOT ALLOWED WITH THE WRITTEN.	GENEL TOLERANS : PROFİL BOY TOLERANSI :	MATERİYAL : MM MDF	TARİH / DATE 09.11.2018

36 mm Profiles

PROFİLSE - SİLAS ORMAN ÜRÜNLERİ

KAĞIT ÜZERİNDEN ÖLÇÜ ALMAYINIZ !!!

ÜRÜN KODU : 36*65

Don't measurate on paper.

(Product Code)

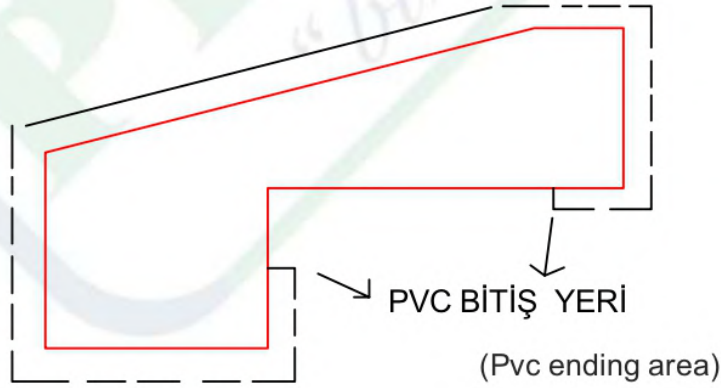
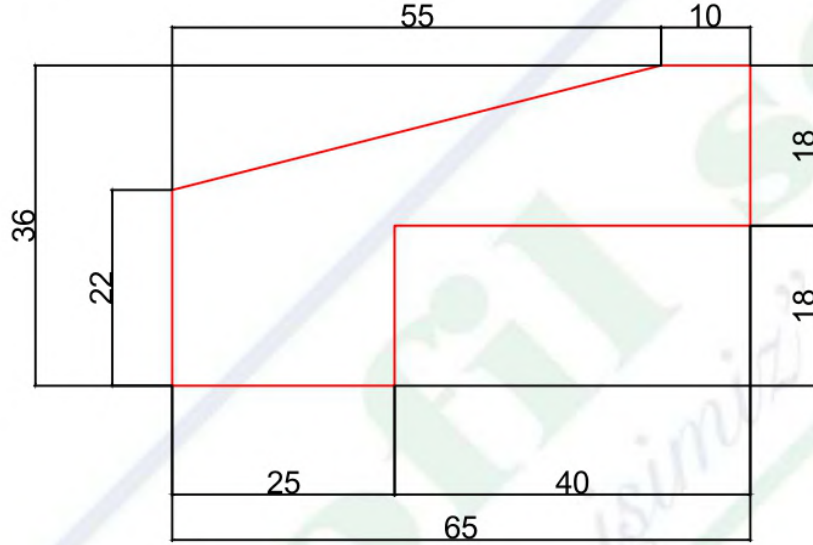

BÖLÜM SORUMLUSU NEJDET ALTINTOPRAK	BU ÇİZİM PROFİLSE - SİLAS ORMAN ÜRÜNLERİ'NE AITTİR. İZINSİZ ÇOĞALTILMAMAK VE KOPYA EDİLMEMEK ŞARTI İLE İZİN VERİLMİŞTİR.	PVC ENİ : MDF MİKTARI : PLAKADAN ÇIKAN :	KSM ÖLÇÜCÜ :	KUTU İÇİ : KUTU İÇİ ADET :
ARGE SORUMLUSU DOĞUKAN DEMİR	THIS DRAWING PROFILE - SİLAS FOREST PRODUCTS WHAT TO DO. UNLOCKED AND COPY NOT ALLOWED WITH THE WRITTEN.	GENEL TOLERANS : PROFL BOY TOLERANSI :	MATERİAL : MM MDF	TARİH / DATE : 10.10.2018

36 mm Profiles

PROFİLSE - SİLAS ORMAN ÜRÜNLERİ

KAĞIT ÜZERİNDEN ÖLÇÜ ALMAYINIZ !!!
Don't measure on paper.

ÜRÜN KODU : 38*66

(Product Code)

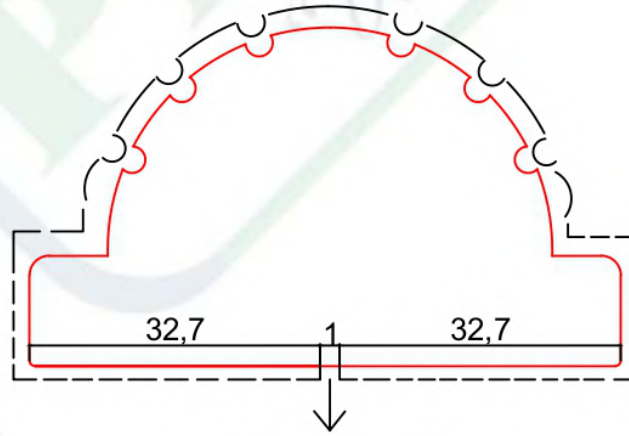
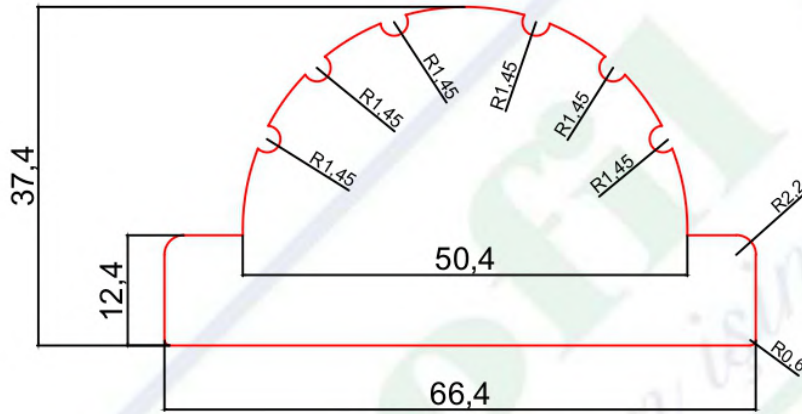

PVC BİTİŞ YERİ
(Pvc ending area)

BÖLÜM SORUMLUSU NEJDET ALTINTOPRAK	BU ÇİZİM PROFİLSE - SİLAS ORMAN ÜRÜNLERİ'NE AİTTİR. İZINSİZ ÇOĞALTILMAMAK VE KOPYA EDİLMEKEMEK ŞARTI İLE İZİN VERİLMİŞTİR.	PVC ENİ : MDF MİKTARI : PLAKADAN ÇIKAN :	KSM ÖLÇÜCÜ :	KUTU İÇİ : KUTU İÇİ ADET :
ARGE SORUMLUSU DOĞUKAN DEMİR	THIS DRAWING PROFILE - SİLAS FOREST PRODUCTS WHAT TO DO. UNLOCKED AND COPY NOT ALLOWED WITH THE WRITTEN.	GENEL TOLERANS : PROFİL BOY TOLERANSI :	MATERİYAL MM MDF	TARİH / DATE 10.12.2018

36 mm Profiles

PROFİLSE - SİLAS ORMAN ÜRÜNLERİ

KAĞIT ÜZERİNDEN ÖLÇÜ ALMAYINIZ !!!

ÜRÜN KODU : 36*91

Don't measurate on paper.

(Product Code)

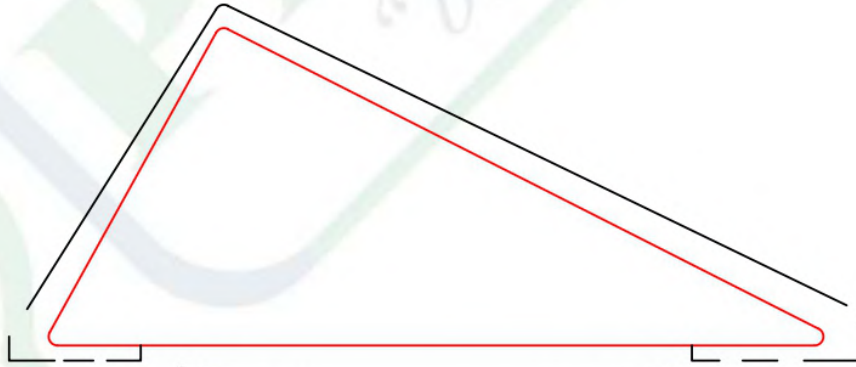
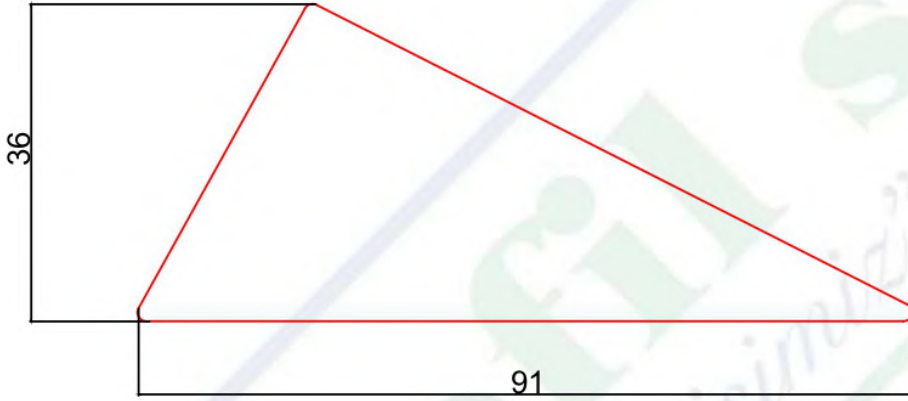

PVC BİTİŞ YERİ

(Pvc ending area)

BÖLÜM SORUMLUSU NEJDET ALTINTOPRAK	BU ÇİZİM PROFİLSE - SİLAS ORMAN ÜRÜNLERİ'NE AİTTİR. İZINSİZ ÇOĞALTILMAMAK VE KOPYA EDİLMEMEK ŞARTI İLE İZİN VERİLMİŞTİR.	PVC ENİ : MDF MİKTARI : PLAKADAN ÇIKAN :	KSM ÖLÇÜCÜ :	KUTU İÇİ : KUTU İÇİ ADET :
ARGE SORUMLUSU DOĞUKAN DEMİR	THIS DRAWING PROFILE - SİLAS FOREST PRODUCTS WHAT TO DO. UNLOCKED AND COPY NOT ALLOWED WITH THE WRITTEN.	GENEL TOLERANS : PROFİL BOY TOLERANSI :	MATERİYAL MM MDF	TARİH / DATE 03.10.2018

36 mm Profiles

PROFİLSE - SİLAS ORMAN ÜRÜNLERİ

KAĞIT ÜZERİNDEN ÖLÇÜ ALMAYINIZ !!!
Don't measure on paper.

ÜRÜN KODU : 36*63

(Product Code)

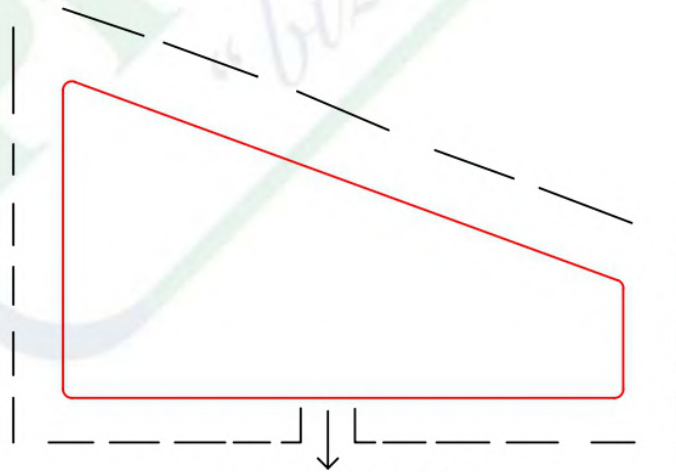
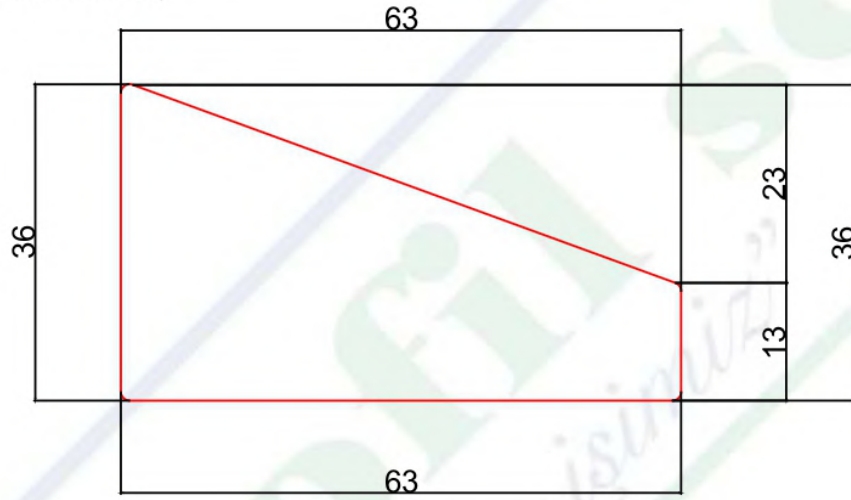

PVC BİTİŞ YERİ
(Pvc ending area)

BÖLÜM SORUMLUSU NEJDET ALTINTOPRAK	BU ÇİZİM PROFİLSE - SİLAS ORMAN ÜRÜNLERİ'NE AİTTİR. İZINSİZ ÇOĞALTILMAMAK VE KOPYA EDİLMEMEK ŞARTI İLE İZİN VERİLMİŞTİR.	PVC ENİ : MDF MİKTARI : PLAKADAN ÇIKAN :	KSM ÖLÇÜCÜ :	KUTU İÇİ : KUTU İÇİ ADET :
ARGE SORUMLUSU DOĞUKAN DEMİR	THIS DRAWING PROFILE - SİLAS FOREST PRODUCTS WHAT TO DO. UNLOCKED AND COPY NOT ALLOWED WITH THE WRITTEN.	GENEL TOLERANS : PROFİL BOY TOLERANSI :	MATERIAL MM MDF	TARİH / DATE 04.10.2018

36 mm Profiles

PROFİLSE - SİLAS ORMAN ÜRÜNLERİ

KAĞIT ÜZERİNDEN ÖLÇÜ ALMAYINIZ !!!
Don't measure on paper.

ÜRÜN KODU : 36*36
(Product Code)

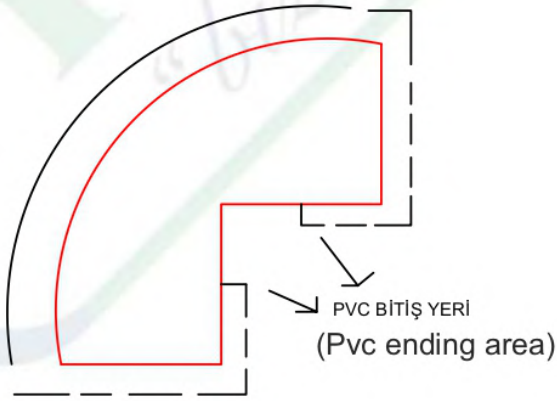
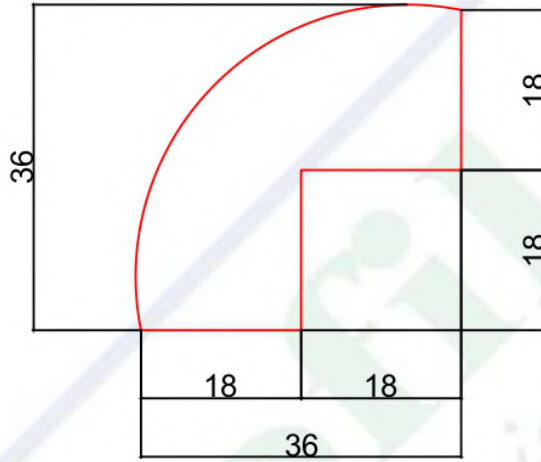

BÖLÜM SORUMLUSU NEJDET ALTINTOPRAK	BU ÇİZİM PROFİLSE - SİLAS ORMAN ÜRÜNLERİ'NE AİTTİR. İZİNSİZ ÇOĞALTILMAMAK VE KOPYA EDİLMEMEK ŞARTI İLE İZİN VERİLMİŞTİR.	PVC ENİ : MDF MİKTARI : PLAKADAN ÇIKAN :	KSM ÖLÇÜCÜ :	KUTU İÇİ : KUTU İÇİ ADET :
ARGE SORUMLUSU DOĞUKAN DEMİR	THIS DRAWING PROFILE - SİLAS FOREST PRODUCTS WHAT TO DO. UNLOCKED AND COPY NOT ALLOWED WITH THE WRITTEN.	GENEL TOLERANS : PROFİL BOY TOLERANSI :	MATERIAL MM MDF	TARİH / DATE 10.10.2018

36 mm Profiles

PROFİLSE - SİLAS ORMAN ÜRÜNLERİ

KAĞIT ÜZERİNDEN ÖLÇÜ ALMAYINIZ !!!
Don't measure on paper.

ÜRÜN KODU : 36*50-14
(Product Code)

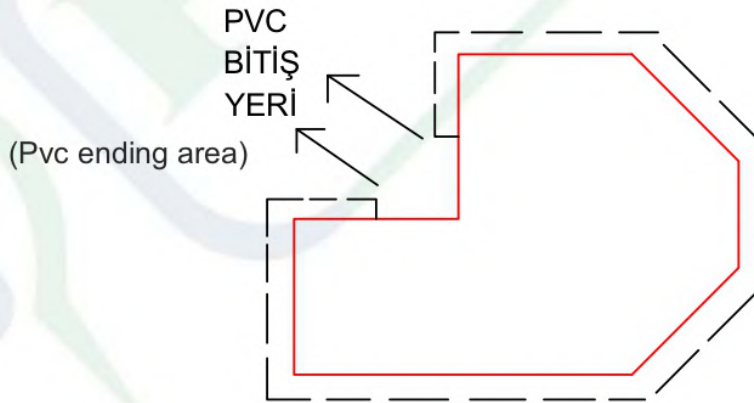
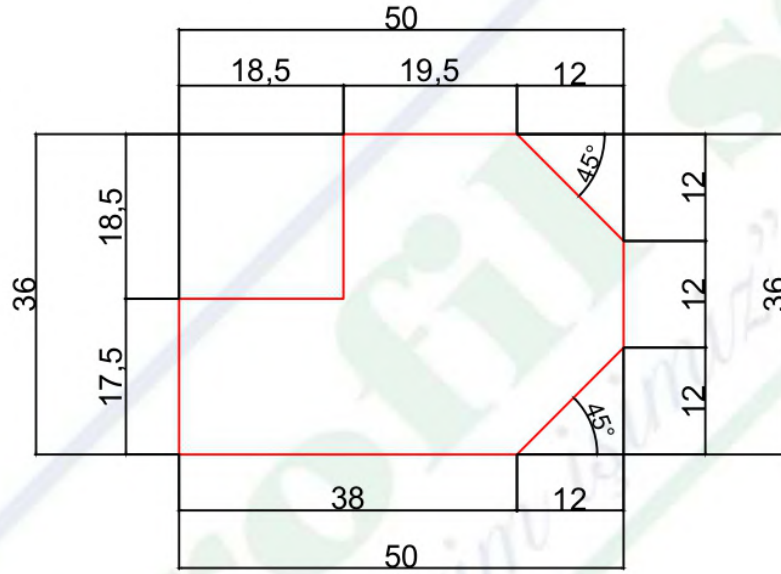

BÖLÜM SORUMLUSU NEJDET ALTINTOPRAK	BU ÇİZİM PROFİLSE - SİLAS ORMAN ÜRÜNLERİ'NE AİTTİR. İZİNSİZ ÇOĞALTILMAMAK VE KOPYA EDİLMEKEMEK ŞARTI İLE İZİN VERİLMİŞTİR.	PVC ENİ : MDF MİKTARI : PLAKADAN ÇIKAN :	KSM ÖLÇÜCÜ :	KUTU İÇİ : KUTU İÇİ ADET :
ARGE SORUMLUSU DOĞUKAN DEMİR	THIS DRAWING PROFILE - SİLAS FOREST PRODUCTS WHAT TO DO. UNLOCKED AND COPY NOT ALLOWED WITH THE WRITTEN.	GENEL TOLERANS : PROFİL BOY TOLERANSI :	MATERİYAL MM MDF	TARİH / DATE 18.01.2019

36 mm Profiles

PROFİLSE - SİLAS ORMAN ÜRÜNLERİ

KAĞIT ÜZERİNDEN ÖLÇÜ ALMAYINIZ !!!
Don't measure on paper.

ÜRÜN KODU : 36*50
(Product Code)

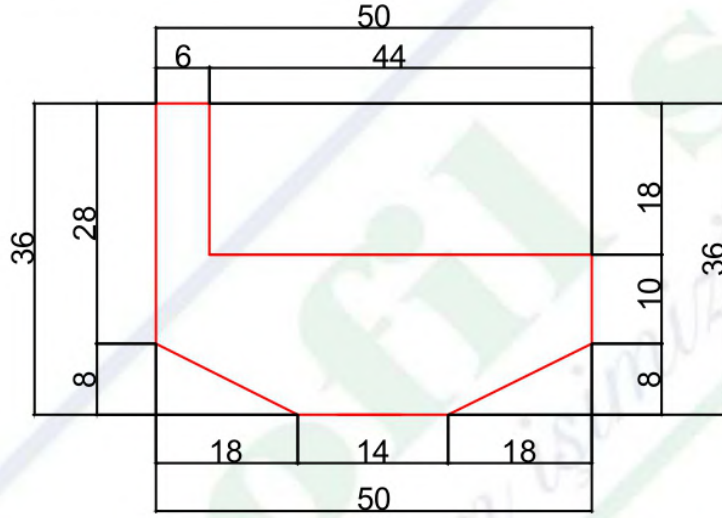

(Pvc ending area)

PVC BİTİŞ YERİ

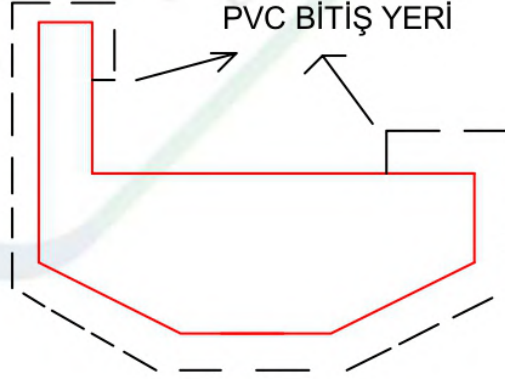

BÖLÜM SORUMLUSU NEJDET ALTINTOPRAK	BU ÇİZİM PROFİLSE - SİLAS ORMAN ÜRÜNLERİ'NE AİTTİR. İZİNSİZ ÇOĞALTILMAMAK VE KOPYA EDİLMEKEMEK ŞARTI İLE İZİN VERİLMİŞTİR.	PVC ENİ : MDF MIKTARI : PLAKADAN ÇIKAN :	KSM ÖLÇÜCÜ :	KUTU İÇİ : KUTU İÇİ ADET :
ARGE SORUMLUSU DOĞUKAN DEMİR	THIS DRAWING PROFILE - SİLAS FOREST PRODUCTS WHAT TO DO. UNLOCKED AND COPY NOT ALLOWED WITH THE WRITTEN.	GENEL TOLERANS : PROFİL BOY TOLERANSI :	MATERIAL MM MDF	TARİH / DATE 04.10.2018

36 mm Profiles

PROFİLSE - SİLAS ORMAN ÜRÜNLERİ

KAĞIT ÜZERİNDEN ÖLÇÜ ALMAYINIZ !!!

Don't measurate on paper.

ÜRÜN KODU : 36*70

(Product Code)

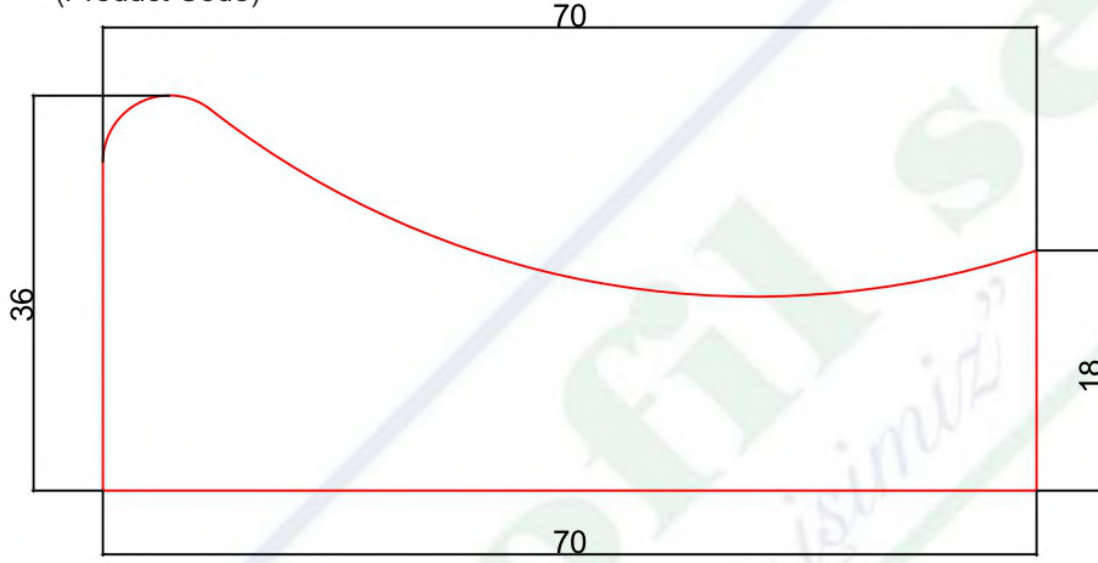

(Pvc ending area)
PVC BİTİŞ YERİ

BÖLÜM SORUMLUSU NEJDET ALTINTOPRAK	BU ÇİZİM PROFİLSE - SİLAS ORMAN ÜRÜNLERİ'NE AİTTİR. İZINSİZ ÇOĞALTILMAMAK VE KOPYA EDİLMEK ŞARTI İLE İZİN VERİLMİŞTİR.	PVC ENİ : MDF MİKTARI : PLAKADAN ÇIKAN :	KSM ÖLÇÜCÜ :	KUTU İÇİ : KUTU İÇİ ADET :
ARGE SORUMLUSU DOĞUKAN DEMİR	THIS DRAWING PROFILE - SİLAS FOREST PRODUCTS WHAT TO DO. UNLOCKED AND COPY NOT ALLOWED WITH THE WRITTEN.	GENEL TOLERANS : PROFİL BOY TOLERANSI :	MATERİYAL MM MDF	TARİH / DATE 12.11.2018

36 mm Profiles

PROFİLSE - SİLAS ORMAN ÜRÜNLERİ

KAĞIT ÜZERİNDEN ÖLÇÜ ALMAYINIZ !!!
Don't measure on paper.

ÜRÜN KODU : 36*50
(Product Code)

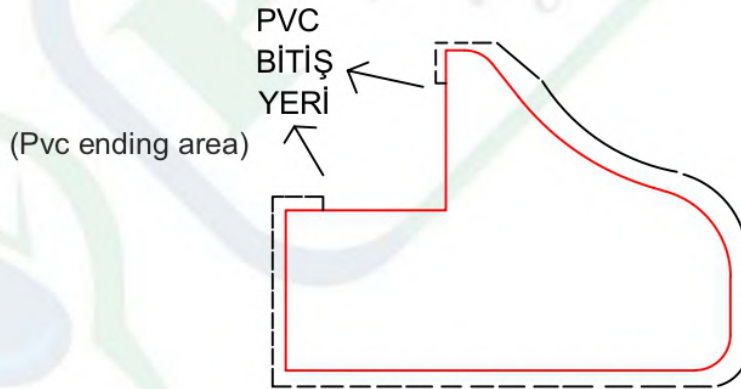
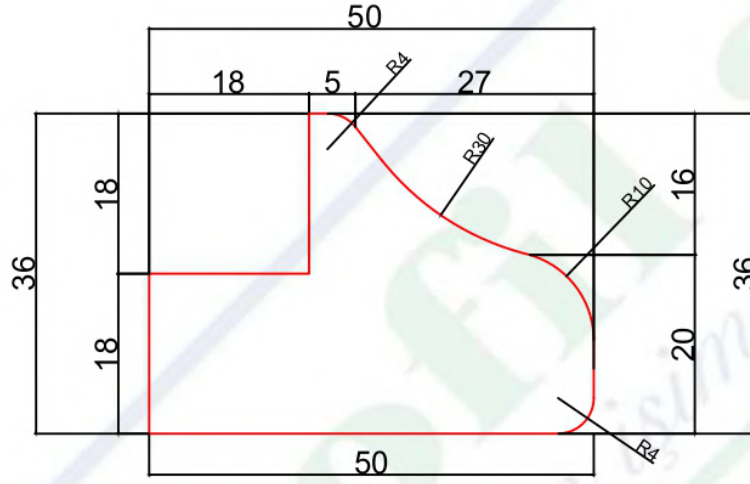

BÖLÜM SORUMLUSU NEJDET ALTINTOPRAK	BU ÇİZİM PROFİLSE - SİLAS ORMAN ÜRÜNLERİ'NE AİTTİR. İZINSİZ ÇOĞALTILMAMAK VE KOPYA EDİLMEMEK ŞARTI İLE İZİN VERİLMİŞTİR.	PVC ENİ : MDF MİKTARI : PLAKADAN ÇIKAN :	KSM ÖLÇÜCÜ :	KUTU İÇİ : KUTU İÇİ ADET :
ARGE SORUMLUSU DOĞUKAN DEMİR	THIS DRAWING PROFILE - SILAS FOREST PRODUCTS WHAT TO DO. UNLOCKED AND COPY NOT ALLOWED WITH THE WRITTEN.	GENEL TOLERANS : PROFİL BOY TOLERANSI :	MATERİYAL MM MDF	TARİH / DATE 06.12.2018

36 mm Profiles

PROFİLSE - SİLAS ORMAN ÜRÜNLERİ

KAĞIT ÜZERİNDEN ÖLÇÜ ALMAYINIZ !!!
Don't measure on paper.

ÜRÜN KODU : 36*60
(Product Code)

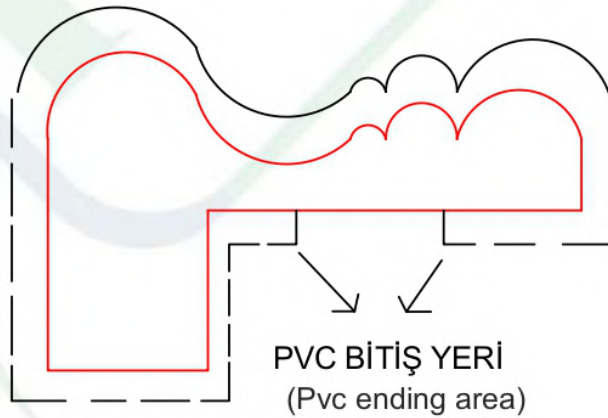
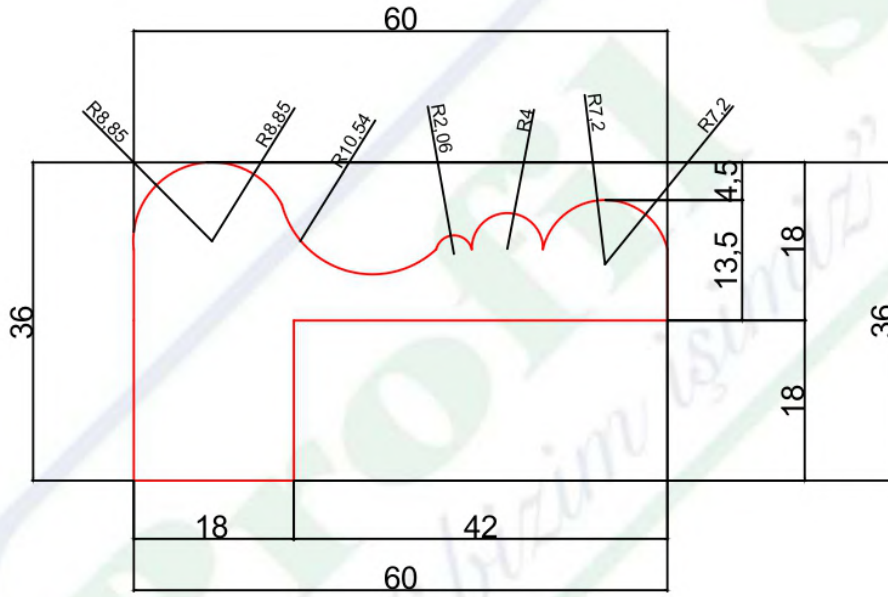

BÖLÜM SORUMLUSU NEJDET ALTINTOPRAK	BU ÇİZİM PROFİLSE - SİLAS ORMAN ÜRÜNLERİ'NE AITTİR. İZİNSİZ ÇOĞALTILMAMAK VE KOPYA EDİLMEMEK ŞARTI İLE İZİN VERİLMİŞTİR.	PVC ENİ : MDF MİKTARI : PLAKADAN ÇIKAN :	KSM ÖLÇÜCÜ :	KUTU İÇİ : KUTU İÇİ ADET :
ARGE SORUMLUSU DOĞUKAN DEMİR	THIS DRAWING PROFILE - SİLAS FOREST PRODUCTS WHAT TO DO. UNLOCKED AND COPY NOT ALLOWED WITH THE WRITTEN.	GENEL TOLERANS : PROFİL BOY TOLERANSI :	MATERİYAL MM MDF	TARİH / DATE 20.02.2019

36 mm Profiles

PROFİLSE - SİLAS ORMAN ÜRÜNLERİ

KAĞIT ÜZERİNDEN ÖLÇÜ ALMAYINIZ !!!

Don't measure on paper.

ÜRÜN KODU : 36*48

(Product Code)

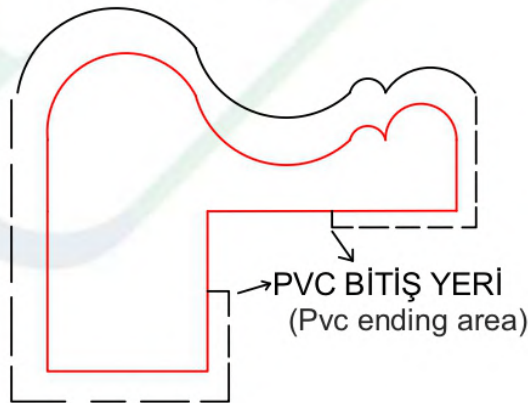
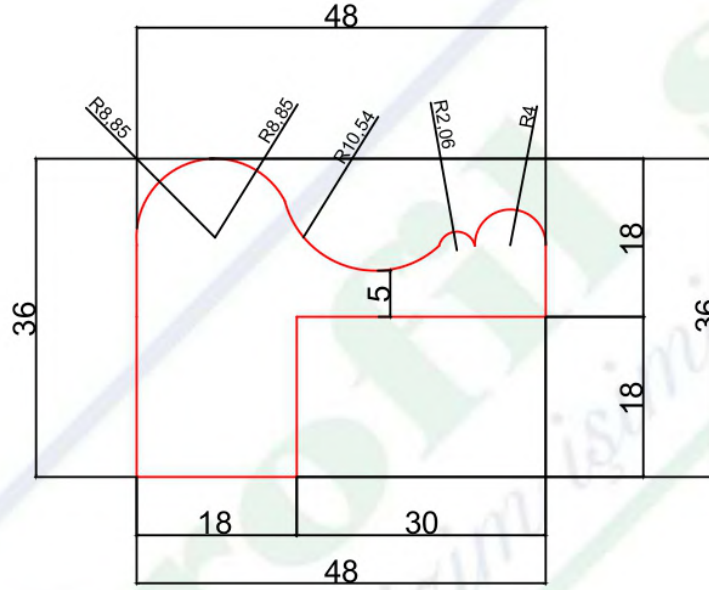

BÖLÜM SORUMLUSU NEJDET ALTINTOPRAK	BU ÇİZİM PROFİLSE - SİLAS ORMAN ÜRÜNLERİ'NE AİTTİR. İZINSİZ ÇOĞALTILMAMAK VE KOPYA EDİLMEMEK ŞARTI İLE İZİN VERİLMİŞTİR.	PVC ENİ : MDF MİKTARI : PLAKADAN ÇIKAN :	KSM ÖLÇÜCÜ :	KUTU İÇİ : KUTU İÇİ ADET :
ARGE SORUMLUSU DOĞUKAN DEMİR	THIS DRAWING PROFILE - SILAS FOREST PRODUCTS WHAT TO DO. UNLOCKED AND COPY NOT ALLOWED WITH THE WRITTEN.	GENEL TOLERANS : PROFİL BOY TOLERANSI :	MATERİYAL MM MDF	TARİH / DATE 20.02.2019

36 mm Profiles

PROFİLSE - SİLAS ORMAN ÜRÜNLERİ

KAĞIT ÜZERİNDEN ÖLÇÜ ALMAYINIZ !!!

ÜRÜN KODU : 35*55

Don't measurate on paper.

(Product Code)

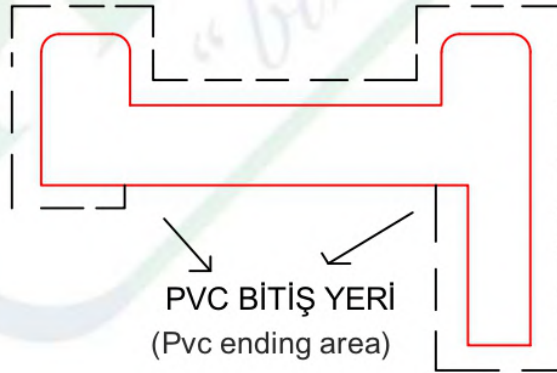
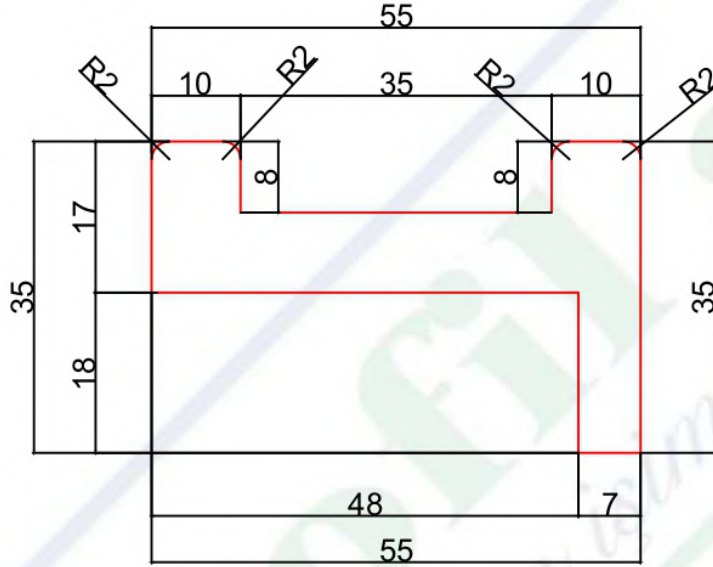

BÖLÜM SORUMLUSU NEJDET ALTINTOPRAK	BU ÇİZİM PROFİLSE - SİLAS ORMAN ÜRÜNLERİ'NE AİTTİR. İZINSİZ ÇOĞALTILMAMAK VE KOPYA EDİLMEMEK ŞARTI İLE İZİN VERİLMİŞTİR.	PVC ENİ : MDF MİKTARI : PLAKADAN ÇIKAN :	KSM ÖLÇÜCÜ :	KUTU İÇİ : KUTU İÇİ ADET :
ARGE SORUMLUSU DOĞUKAN DEMİR	THIS DRAWING PROFILE - SİLAS FOREST PRODUCTS WHAT TO DO. UNLOCKED AND COPY NOT ALLOWED WITH THE WRITTEN.	GENEL TOLERANS : PROFİL BOY TOLERANSI :	MATERİYAL MM MDF	TARİH / DATE 10.10.2018

36 mm Profiles

PROFİLSE - SİLAS ORMAN ÜRÜNLERİ

KAĞIT ÜZERİNDEN ÖLÇÜ ALMAYINIZ !!!

Don't measurate on paper.

ÜRÜN KODU : 36*65

(Product Code)

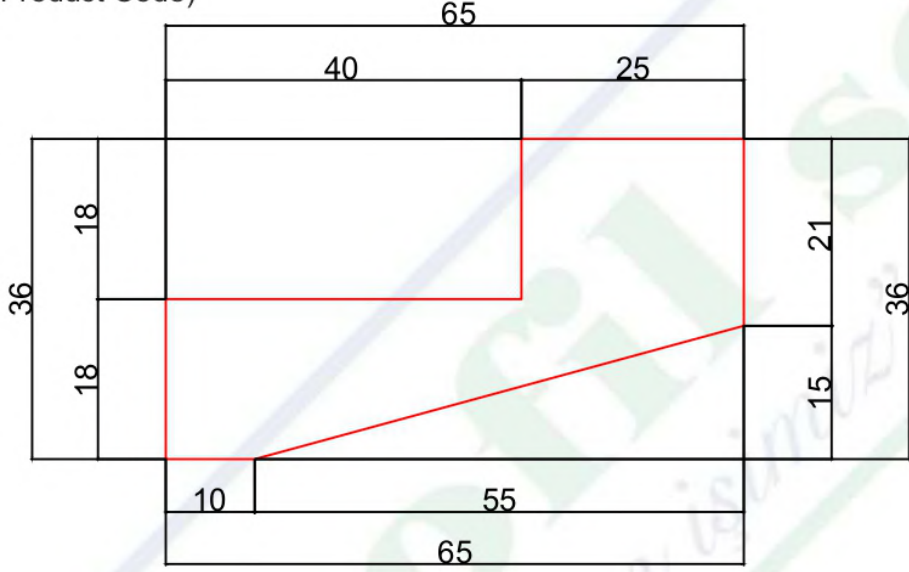

(Pvc ending area)

PVC BİTİŞ YERİ

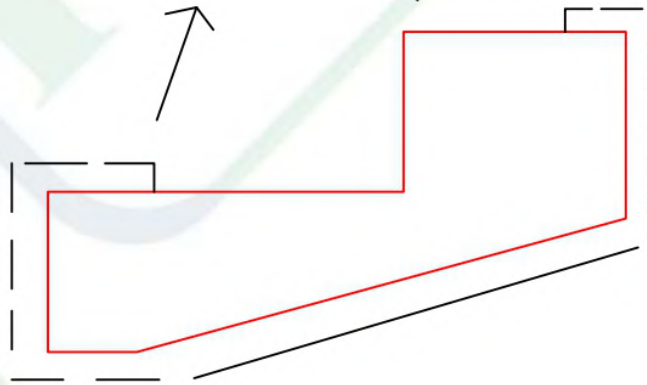

BÖLÜM SORUMLUSU NEJDET ALTINTOPRAK	BU ÇİZİM PROFİLSE - SİLAS ORMAN ÜRÜNLERİ'NE AİTTİR. İZİNSİZ ÇOĞALTILMAMAK VE KOPYA EDİLMEKEMEK ŞARTI İLE İZİN VERİLMİŞTİR.	PVC ENİ : MDF MİKTARI : PLAKADAN ÇIKAN :	KSM ÖLÇÜCÜ :	KUTU İÇİ : KUTU İÇİ ADET :
ARGE SORUMLUSU DOĞUKAN DEMİR	THIS DRAWING PROFILE - SİLAS FOREST PRODUCTS WHAT TO DO. UNLOCKED AND COPY NOT ALLOWED WITH THE WRITTEN.	GENEL TOLERANS : PROFL BOY TOLERANSI :	MATERİAL MM MDF	TARİH / DATE 10.10.2018

36 mm Profiles

PROFİLSE - SİLAS ORMAN ÜRÜNLERİ

KAĞIT ÜZERİNDEN ÖLÇÜ ALMAYINIZ !!!
Don't measure on paper.

ÜRÜN KODU : 36*70
(Product Code)

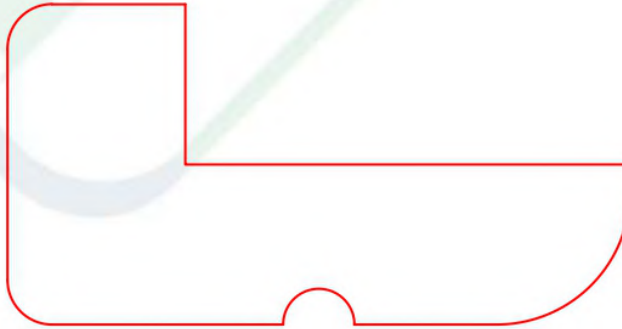
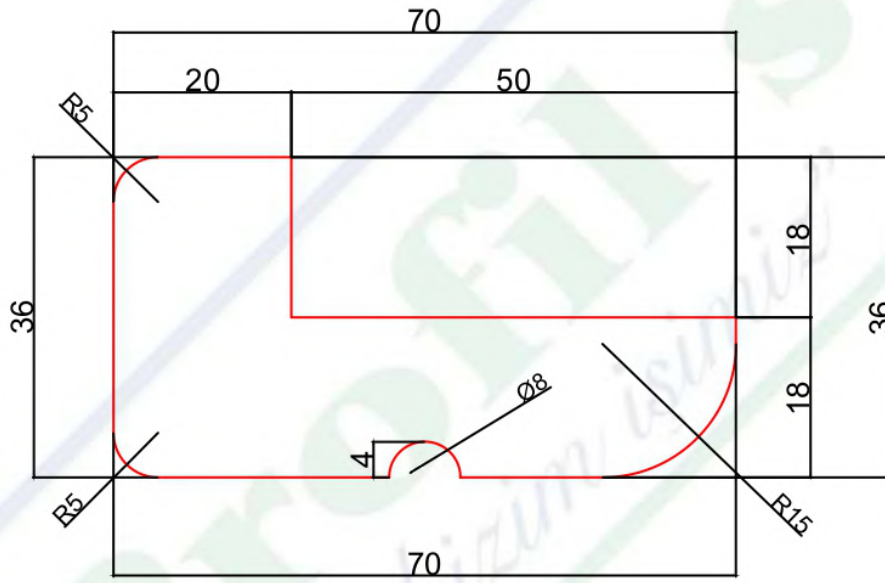

BÖLÜM SORUMLUSU NEJDET ALTINTOPRAK	BU ÇİZİM PROFİLSE - SİLAS ORMAN ÜRÜNLERİ'NE AİTTİR. İZINSİZ ÇOĞALTILMAMAK VE KOPYA EDİLMEKEMEK ŞARTI İLE İZİN VERİLMİŞTİR.	PVC ENİ : MDF MİKTARI : PLAKADAN ÇIKAN :	KSM ÖLÇÜCÜ :	KUTU İÇİ : KUTU İÇİ ADET :
ARGE SORUMLUSU DOĞUKAN DEMİR	THIS DRAWING PROFILE - SİLAS FOREST PRODUCTS WHAT TO DO. UNLOCKED AND COPY NOT ALLOWED WITH THE WRITTEN.	GENEL TOLERANS : PROFİL BOY TOLERANSI :	MATERİYAL MM MDF	TARİH / DATE 28.01.2019

36 mm Profiles

PROFİLSE - SİLAS ORMAN ÜRÜNLERİ

KAĞIT ÜZERİNDEN ÖLÇÜ ALMAYINIZ !!!

ÜRÜN KODU : 36*80 Don't measurate on paper.
(Product Code)

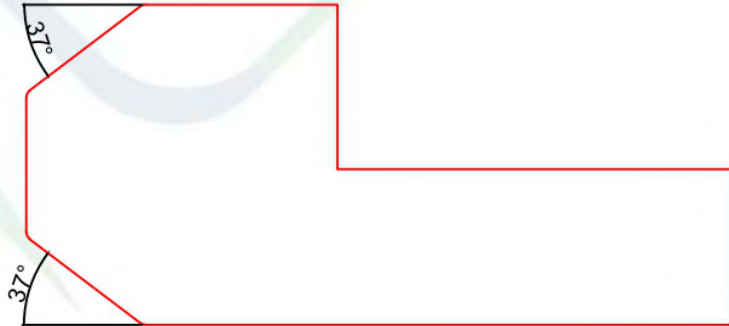
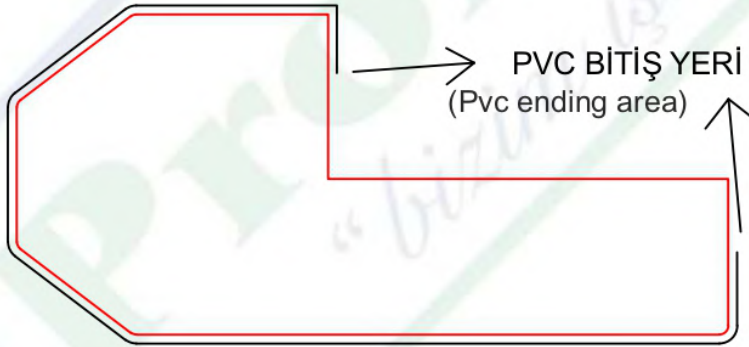
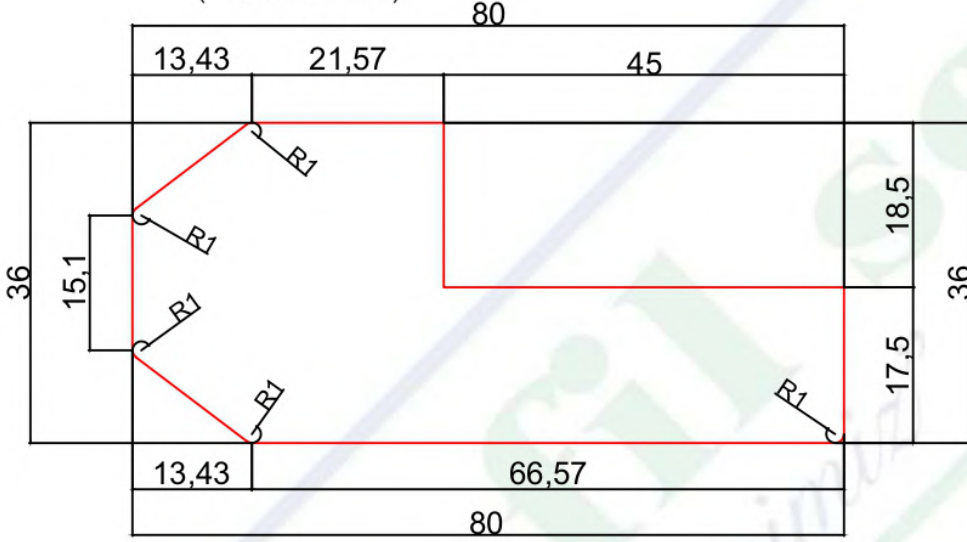

BÖLÜM SORUMLUSU NEJDET ALTINTOPRAK	BU ÇİZİM PROFİLSE - SİLAS ORMAN ÜRÜNLERİ'NE AİTTİR. İZINSİZ ÇOĞALTILMAMAK VE KOPYA EDİLMEMEK ŞARTI İLE İZİN VERİLMİŞTİR.	PVC ENİ : MDF MİKTARI : PLAKADAN ÇIKAN :	KSM ÖLÇÜCÜ :	KUTU İÇİ : KUTU İÇİ ADET :
ARGE SORUMLUSU DOĞUKAN DEMİR	THIS DRAWING PROFILE - SİLAS FOREST PRODUCTS WHAT TO DO. UNLOCKED AND COPY NOT ALLOWED WITH THE WRITTEN.	GENEL TOLERANS : PROFİL BOY TOLERANSI :	MATERİYAL MM MDF	TARİH / DATE 4.01.2019

36 mm Profiles

PROFİLSE - SİLAS ORMAN ÜRÜNLERİ

KAĞIT ÜZERİNDEN ÖLÇÜ ALMAYINIZ !!!
Don't measure on paper.

ÜRÜN KODU : 36*45
(Product Code)

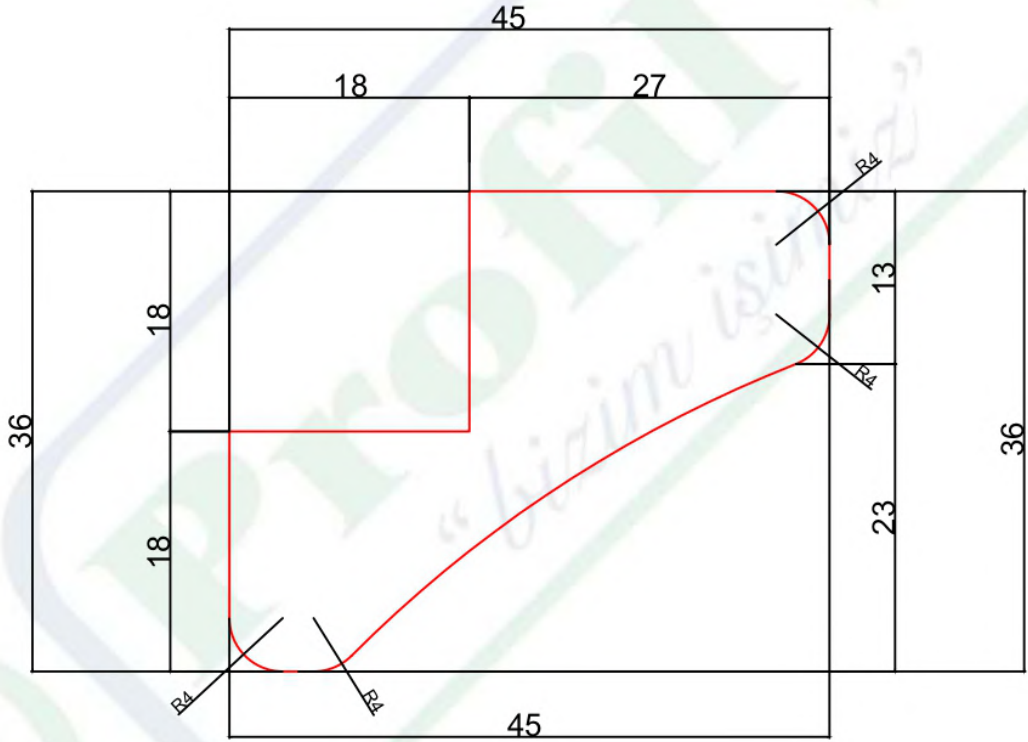

BÖLÜM SORUMLUSU NEJDET ALTINTOPRAK	BU ÇİZİM PROFİLSE - SİLAS ORMAN ÜRÜNLERİ'NE AİTTİR. İZINSİZ ÇOĞALTILMAMAK VE KOPYA EDİLMEK ŞARTI İLE İZİN VERİLMİŞTİR.	PVC ENİ : MDF MİKTARI : PLAKADAN ÇIKAN :	KSM ÖLÇÜCÜ :	KUTU İÇİ : KUTU İÇİ ADET :
ARGE SORUMLUSU DOĞUKAN DEMİR	THIS DRAWING PROFILE - SİLAS FOREST PRODUCTS WHAT TO DO. UNLOCKED AND COPY NOT ALLOWED WITH THE WRITTEN.	GENEL TOLERANS : PROFİL BOY TOLERANSI :	MATERİYAL MM MDF	TARİH / DATE 26.11.2018

36 mm Profiles

PROFİLSE - SİLAS ORMAN ÜRÜNLERİ

KAĞIT ÜZERİNDEN ÖLÇÜ ALMAYINIZ !!!

Don't measurate on paper.

ÜRÜN KODU : 36*80
(Product Code)

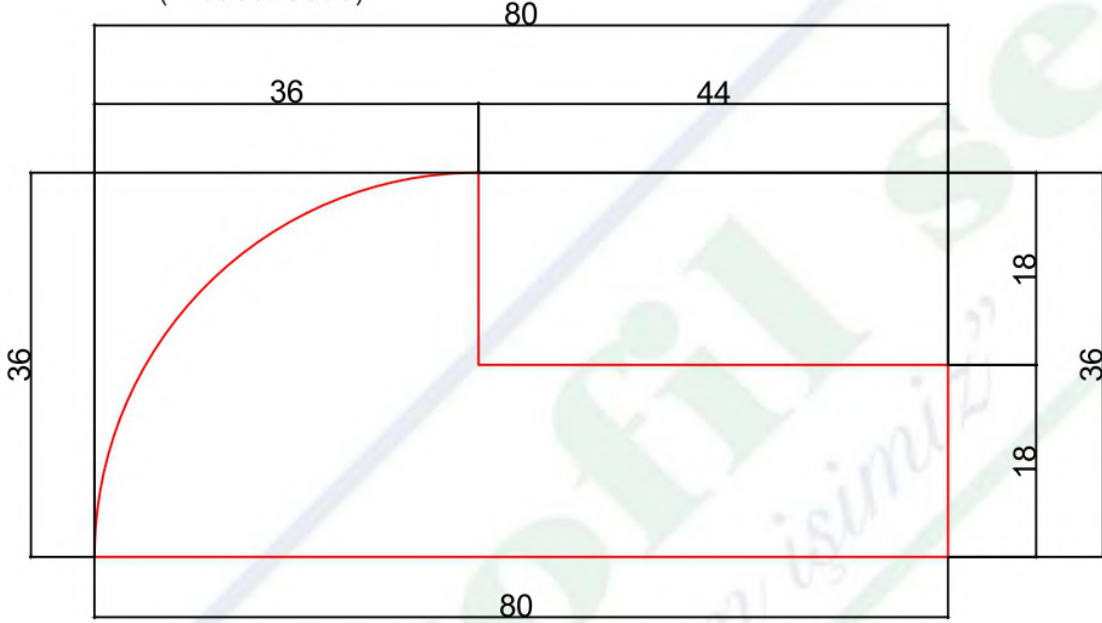

(Pvc ending area)

PVC BİTİŞ YERİ

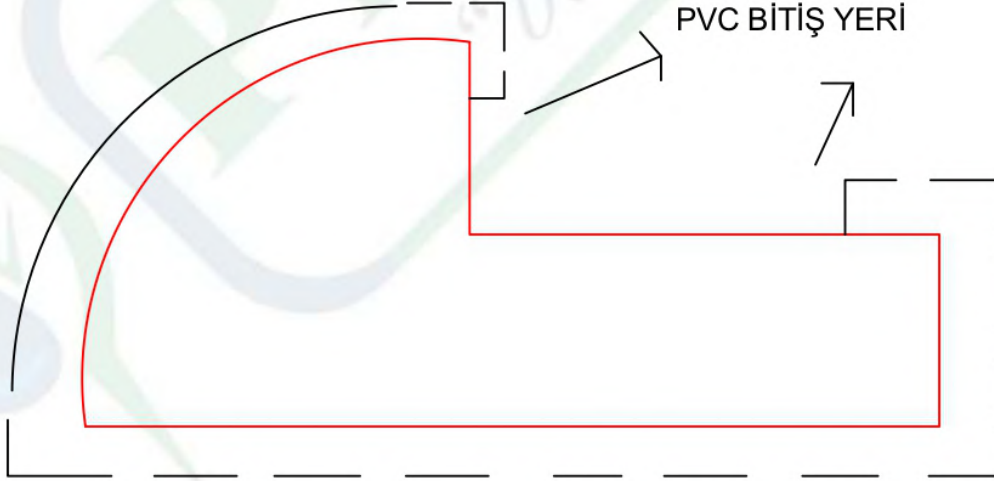

BÖLÜM SORUMLUSU NEJDET ALTINTOPRAK	BU ÇİZİM PROFİLSE - SİLAS ORMAN ÜRÜNLERİ'NE AİTTİR. İZINSİZ ÇOĞALTILMAMAK VE KOPYA EDİLMEMEK ŞARTI İLE İZİN VERİLMİŞTİR.	PVC ENİ : MDF MİKTARI : PLAKADAN ÇIKAN :	KSM ÖLÇÜCÜ :	KUTU İÇİ : KUTU İÇİ ADET :
ARGE SORUMLUSU DOĞUKAN DEMİR	THIS DRAWING PROFILE - SİLAS FOREST PRODUCTS WHAT TO DO. UNLOCKED AND COPY NOT ALLOWED WITH THE WRITTEN.	GENEL TOLERANS : PROFİL BOY TOLERANSI :	MATERİYAL MM MDF	TARİH / DATE 15.11.2018

36 mm Profiles

PROFİLSE - SİLAS ORMAN ÜRÜNLERİ

KAĞIT ÜZERİNDEN ÖLÇÜ ALMAYINIZ !!!

Don't measurate on paper.

ÜRÜN KODU : 36*60
(Product Code)

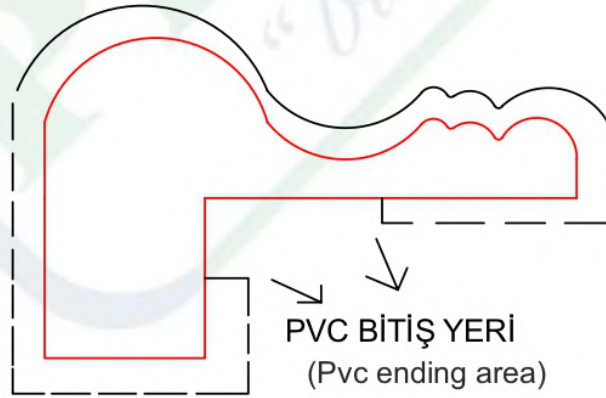
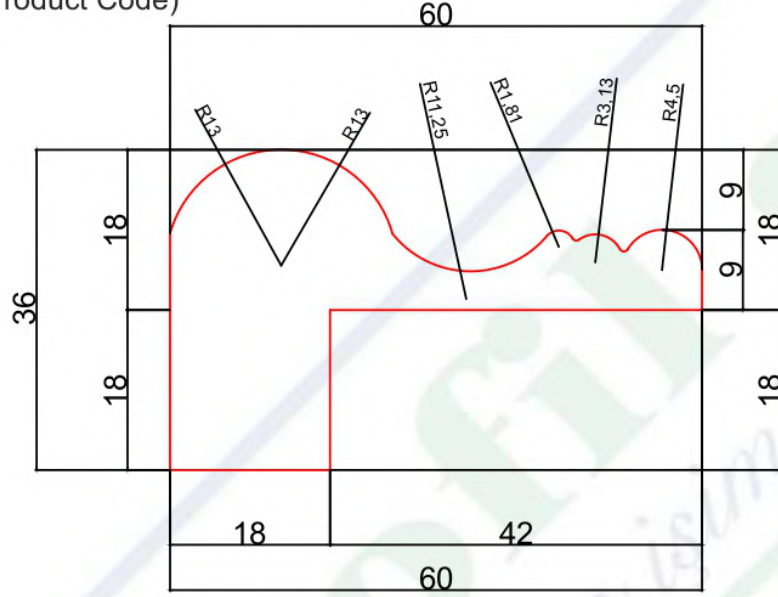

BÖLÜM SORUMLUSU NEJDET ALTINTOPRAK	BU ÇİZİM PROFİLSE - SİLAS ORMAN ÜRÜNLERİ'NE AİTTİR. İZİNSİZ ÇOĞALTILMAMAK VE KOPYA EDİLMEKEMEK ŞARTI İLE İZİN VERİLMİŞTİR.	PVC ENİ : MDF MİKTARI : PLAKADAN ÇIKAN :	KSM ÖLÇÜCÜ :	KUTU İÇİ : KUTU İÇİ ADET :
ARGE SORUMLUSU DOĞUKAN DEMİR	THIS DRAWING PROFILE - SİLAS FOREST PRODUCTS WHAT TO DO. UNLOCKED AND COPY NOT ALLOWED WITH THE WRITTEN.	GENEL TOLERANS : PROFL BOY TOLERANSI :	MATERİYAL MM MDF	TARİH / DATE 14.12.2018

40 mm Profiles

PROFİLSE - SİLAS ORMAN ÜRÜNLERİ

KAĞIT ÜZERİNDEN ÖLÇÜ ALMAYINIZ !!!

ÜRÜN KODU : 40*60
(Product Code)

Don't measurate on paper.

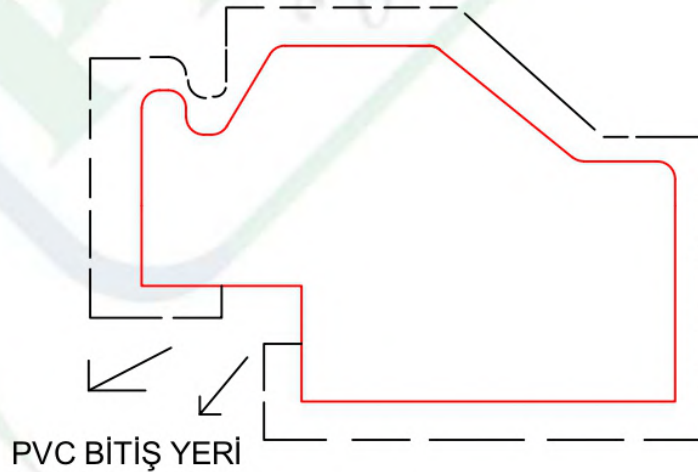
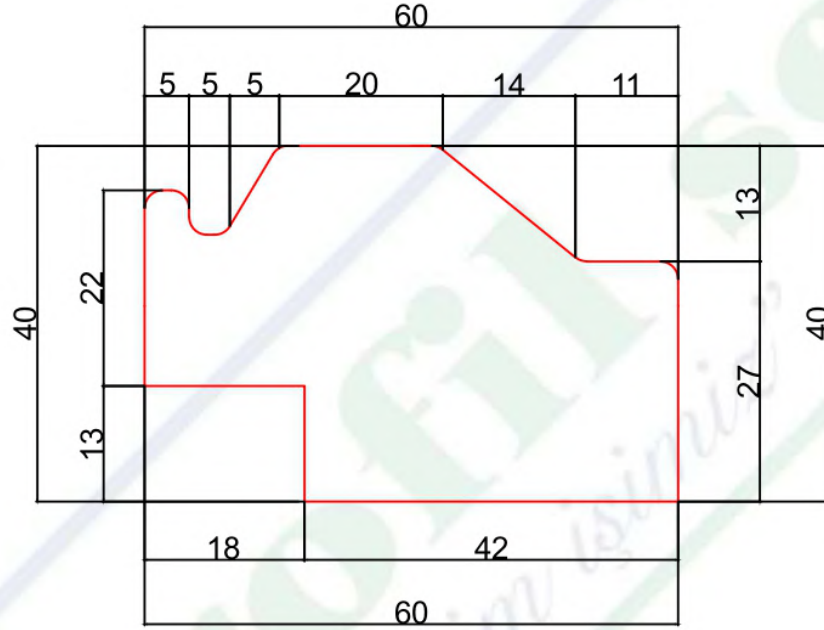

(Pvc ending area)

BÖLÜM SORUMLUSU NEJDET ALTINTOPRAK	BU ÇİZİM PROFİLSE - SİLAS ORMAN ÜRÜNLERİ'NE AİTTİR. İZINSİZ ÇOĞALTILMAMAK VE KOPYA EDİLMEMEK ŞARTI İLE İZİN VERİLMİŞTİR.	PVC ENİ : MDF MİKTARI : PLAKADAN ÇIKAN :	KSM ÖLÇÜCÜ :	KUTU İÇİ : KUTU İÇİ ADET :
ARGE SORUMLUSU DOĞUKAN DEMİR	THIS DRAWING PROFILE - SİLAS FOREST PRODUCTS WHAT TO DO. UNLOCKED AND COPY NOT ALLOWED WITH THE WRITTEN.	GENEL TOLERANS : PROFİL BOY TOLERANSI :	MATERİYAL MM MDF	TARİH / DATE 10.10.2018

40 mm Profiles

PROFİLSE - SİLAS ORMAN ÜRÜNLERİ

KAĞIT ÜZERİNDEN ÖLÇÜ ALMAYINIZ !!!
Don't measure on paper.

ÜRÜN KODU : 40*80
(Product Code)

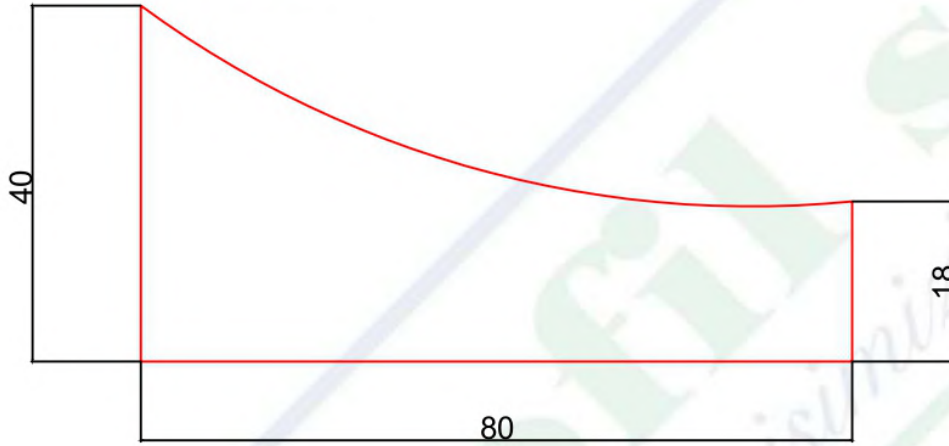

PVC BİTİŞ YERİ
(Pvc ending area)

BÖLÜM SORUMLUSU NEJDET ALTINTOPRAK	BU ÇİZİM PROFİLSE - SİLAS ORMAN ÜRÜNLERİ'NE AİTTİR. İZİNSİZ ÇOĞALTILMAMAK VE KOPYA EDİLMEMEK ŞARTI İLE İZİN VERİLMİŞTİR.	PVC ENİ : MDF MİKTARI : PLAKADAN ÇIKAN :	KSM ÖLÇÜCÜ :	KUTU İÇİ : KUTU İÇİ ADET :
ARGE SORUMLUSU DOĞUKAN DEMİR	THIS DRAWING PROFILE - SİLAS FOREST PRODUCTS WHAT TO DO. UNLOCKED AND COPY NOT ALLOWED WITH THE WRITTEN.	GENEL TOLERANS : PROFİL BOY TOLERANSI :	MATERİYAL MM MDF	TARİH / DATE 12.11.2018

40 mm Profiles

PROFİLSE - SİLAS ORMAN ÜRÜNLERİ

KAĞIT ÜZERİNDEN ÖLÇÜ ALMAYINIZ !!!

Don't measurate on paper.

ÜRÜN KODU : 40*50

(Product Code)

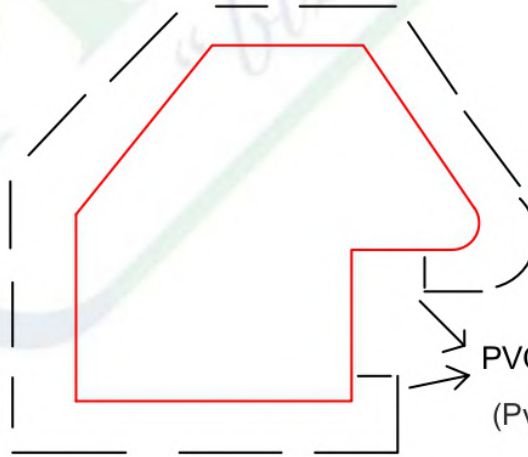
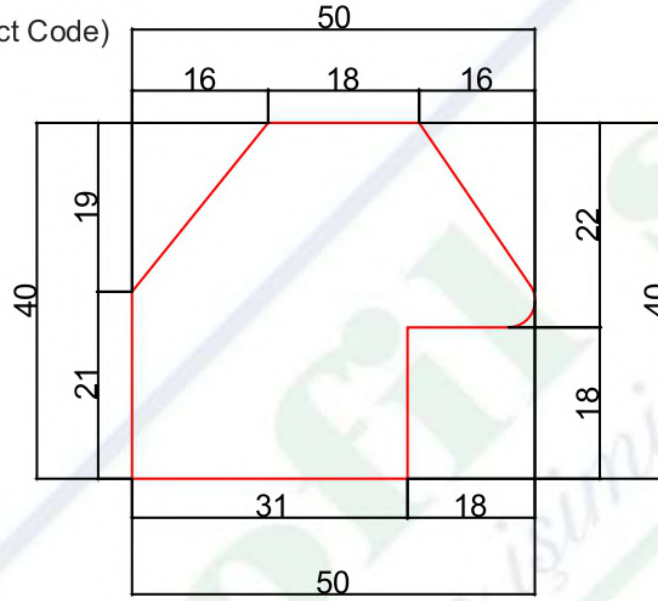

BÖLÜM SORUMLUSU NEJDET ALTINTOPRAK	BU ÇİZİM PROFİLSE - SİLAS ORMAN ÜRÜNLERİ'NE AİTTİR. İZINSİZ ÇOĞALTILMAMAK VE KOPYA EDİLMEK ŞARTI İLE İZİN VERİLMİŞTİR.	PVC ENİ : MDF MİKTARI : PLAKADAN ÇIKAN :	KSM ÖLÇÜCÜ :	KUTU İÇİ : KUTU İÇİ ADET :
ARGE SORUMLUSU DOĞUKAN DEMİR	THIS DRAWING PROFILE - SİLAS FOREST PRODUCTS WHAT TO DO. UNLOCKED AND COPY NOT ALLOWED WITH THE WRITTEN.	GENEL TOLERANS : PROFİL BOY TOLERANSI :	MATERİYAL MM MDF	TARİH / DATE 04.10.2018

40 mm Profiles

PROFİLSE - SİLAS ORMAN ÜRÜNLERİ

KAĞIT ÜZERİNDEN ÖLÇÜ ALMAYINIZ !!!

Don't measure on paper.

ÜRÜN KODU : 40*40
(Product Code)

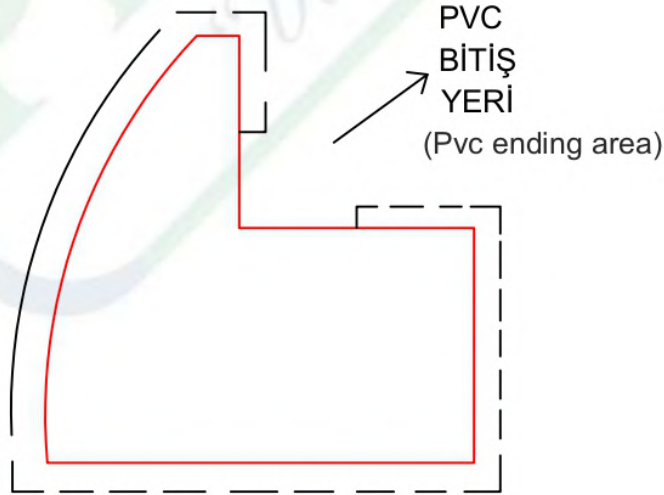
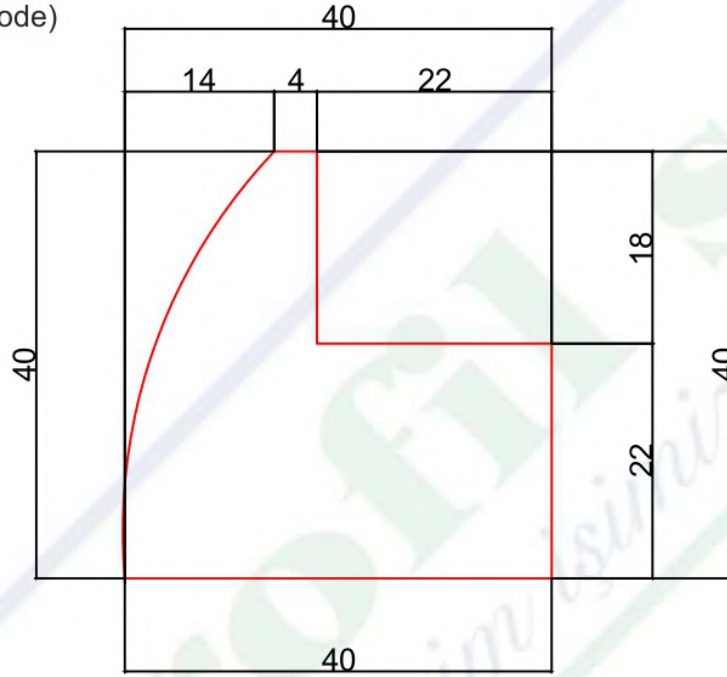

BÖLÜM SORUMLUSU NEJDET ALTINTOPRAK	BU ÇİZİM PROFİLSE - SİLAS ORMAN ÜRÜNLERİ'NE AİTTİR. İZİNSİZ ÇOĞALTILMAMAK VE KOPYA EDİLMEMEK ŞARTI İLE İZİN VERİLMİŞTİR.	PVC ENİ : MDF MİKTARI : PLAKADAN ÇIKAN :	KSM ÖLÇÜCÜ :	KUTU İÇİ : KUTU İÇİ ADET :
ARGE SORUMLUSU DOĞUKAN DEMİR	THIS DRAWING PROFILE - SİLAS FOREST PRODUCTS WHAT TO DO. UNLOCKED AND COPY NOT ALLOWED WITH THE WRITTEN.	GENEL TOLERANS : PROFİL BOY TOLERANSI :	MATERİYAL MM MDF	TARİH / DATE 12.11.2018

40 mm Profiles

PROFİLSE - SİLAS ORMAN ÜRÜNLERİ

KAĞIT ÜZERİNDEN ÖLÇÜ ALMAYINIZ !!!

Don't measurate on paper.

ÜRÜN KODU : 40*40
(Product Code)

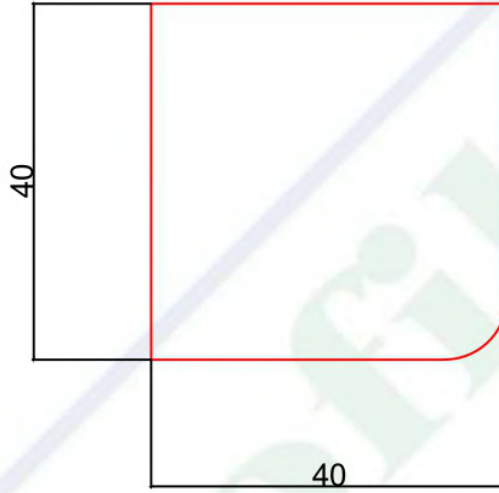

(Pvc ending area)
PVC BİTİŞ YERİ

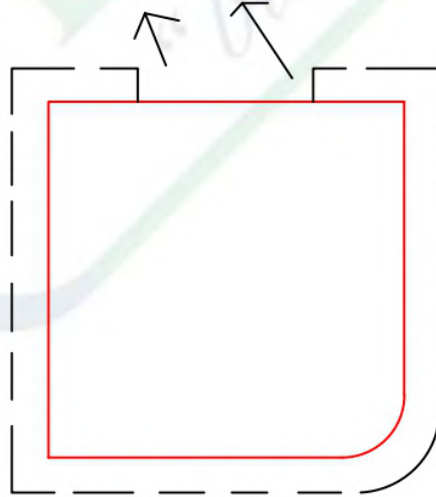

BÖLÜM SORUMLUSU NEJDET ALTINTOPRAK	BU ÇİZİM PROFİLSE - SİLAS ORMAN ÜRÜNLERİ'NE AİTTİR. İZINSİZ ÇOĞALTILMAMAK VE KOPYA EDİLMEMEK ŞARTI İLE İZİN VERİLMİŞTİR.	PVC ENİ : MDF MİKTARI : PLAKADAN ÇIKAN :	KSM ÖLÇÜCÜ :	KUTU İÇİ : KUTU İÇİ ADET :
ARGE SORUMLUSU DOĞUKAN DEMİR	THIS DRAWING PROFILE - SILAS FOREST PRODUCTS WHAT TO DO. UNLOCKED AND COPY NOT ALLOWED WITH THE WRITTEN.	GENEL TOLERANS : PROFL BOY TOLERANSI :	MATERIAL MM MDF	TARİH / DATE 10.09.2018

40 mm Profiles

PROFİLSE - SİLAS ORMAN ÜRÜNLERİ

KAĞIT ÜZERİNDEN ÖLÇÜ ALMAYINIZ !!!

Don't measure on paper.

ÜRÜN KODU : 40*50

(Product Code)

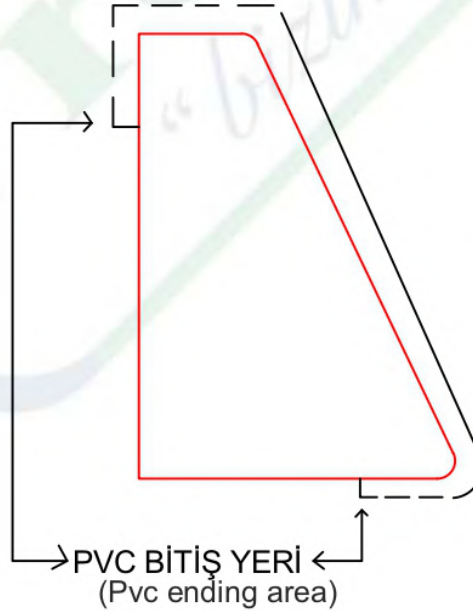
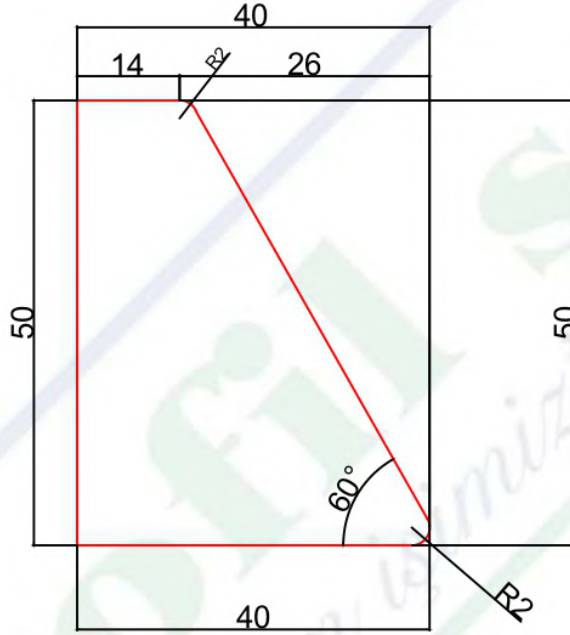

BÖLÜM SORUMLUSU NEJDET ALTINTOPRAK	BU ÇİZİM PROFİLSE - SİLAS ORMAN ÜRÜNLERİ'NE AİTTİR. İZİNSİZ ÇOĞALTILMAMAK VE KOPYA EDİLMEKEMEK ŞARTI İLE İZİN VERİLMİŞTİR.	PVC ENİ : MDF MİKTARI : PLAKADAN ÇIKAN :	KSM ÖLÇÜCÜ :	KUTU İÇİ : KUTU İÇİ ADET :
ARGE SORUMLUSU DOĞUKAN DEMİR	THIS DRAWING PROFILE - SİLAS FOREST PRODUCTS WHAT TO DO. UNLOCKED AND COPY NOT ALLOWED WITH THE WRITTEN.	GENEL TOLERANS : PROFİL BOY TOLERANSI :	MATERİYAL MM MDF	TARİH / DATE 19.11.2018

40 mm Profiles

PROFİLSE - SİLAS ORMAN ÜRÜNLERİ

KAĞIT ÜZERİNDEN ÖLÇÜ ALMAYINIZ !!!

ÜRÜN KODU : 40*70

(Product Code)

Don't measurate on paper.

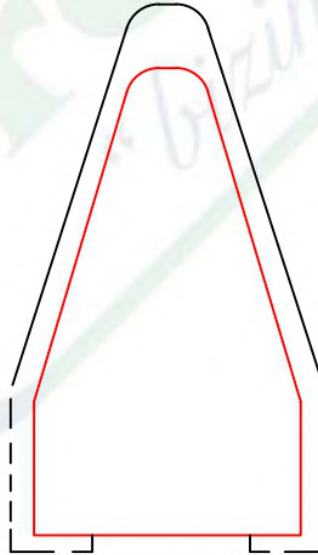
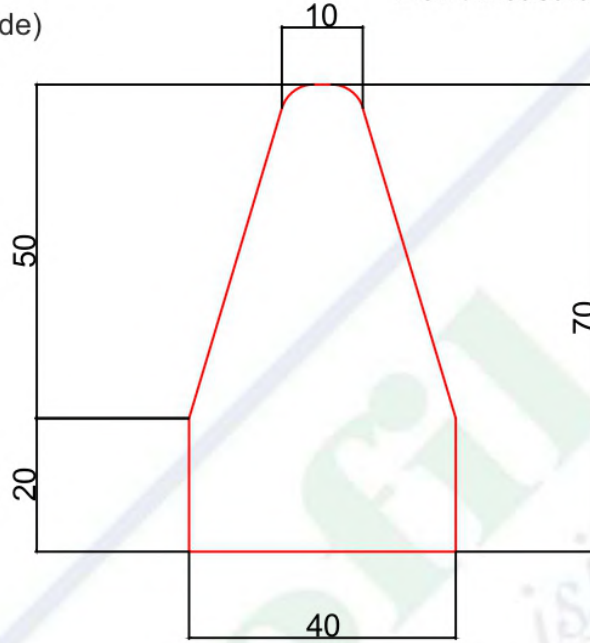

PVC BİTİŞ YERİ
(Pvc ending area)

BÖLÜM SORUMLUSU NEJDET ALTINTOPRAK	BU ÇİZİM PROFİLSE - SİLAS ORMAN ÜRÜNLERİ'NE AİTTİR. İZINSİZ ÇOĞALTILMAMAK VE KOPYA EDİLMEK ŞARTI İLE İZİN VERİLMİŞTİR.	PVC ENİ : MDF MİKTARI : PLAKADAN ÇIKAN :	KSM ÖLÇÜCÜ :	KUTU İÇİ : KUTU İÇİ ADET :
ARGE SORUMLUSU DOĞUKAN DEMİR	THIS DRAWING PROFILE - SILAS FOREST PRODUCTS WHAT TO DO. UNLOCKED AND COPY NOT ALLOWED WITH THE WRITTEN.	GENEL TOLERANS : PROFİL BOY TOLERANSI :	MATERİYAL MM MDF	TARİH / DATE 03.10.2018

40 mm Profiles

PROFİLSE - SİLAS ORMAN ÜRÜNLERİ

KAĞIT ÜZERİNDEN ÖLÇÜ ALMAYINIZ !!!
Don't measure on paper.

ÜRÜN KODU : 40*70
(Product Code)

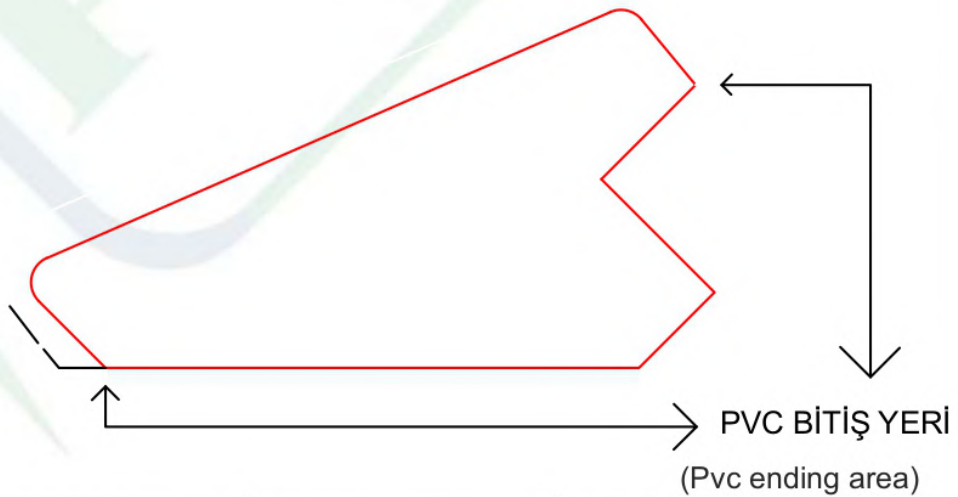
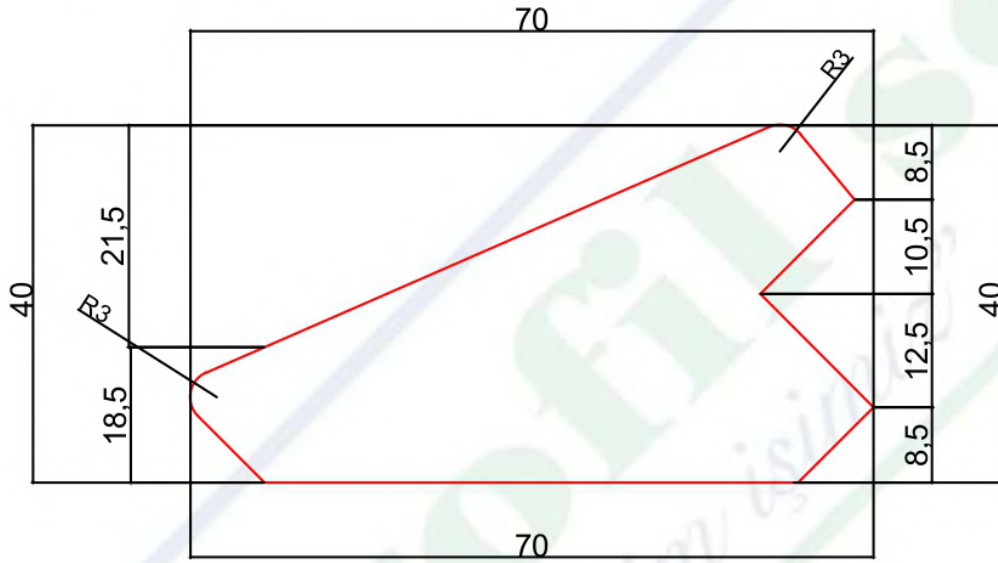

BÖLÜM SORUMLUSU NEJDET ALTINTOPRAK	BU ÇİZİM PROFİLSE - SİLAS ORMAN ÜRÜNLERİ'NE AİTTİR. İZİNSİZ ÇOĞALTILMAMAK VE KOPYA EDİLMEMEK ŞARTI İLE İZİN VERİLMİŞTİR.	PVC ENİ : MDF MİKTARI : PLAKADAN ÇIKAN :	KSM ÖLÇÜCÜ :	KUTU İÇİ : KUTU İÇİ ADET :
ARGE SORUMLUSU DOĞUKAN DEMİR	THIS DRAWING PROFILE - SİLAS FOREST PRODUCTS WHAT TO DO. UNLOCKED AND COPY NOT ALLOWED WITH THE WRITTEN.	GENEL TOLERANS : PROFİL BOY TOLERANSI :	MATERİYAL MM MDF	TARİH / DATE 21.01.2019

42 mm Profiles

PROFİLSE - SİLAS ORMAN ÜRÜNLERİ

KAĞIT ÜZERİNDEN ÖLÇÜ ALMAYINIZ !!!

Don't measurate on paper.

ÜRÜN KODU : 42*118

(Product Code)

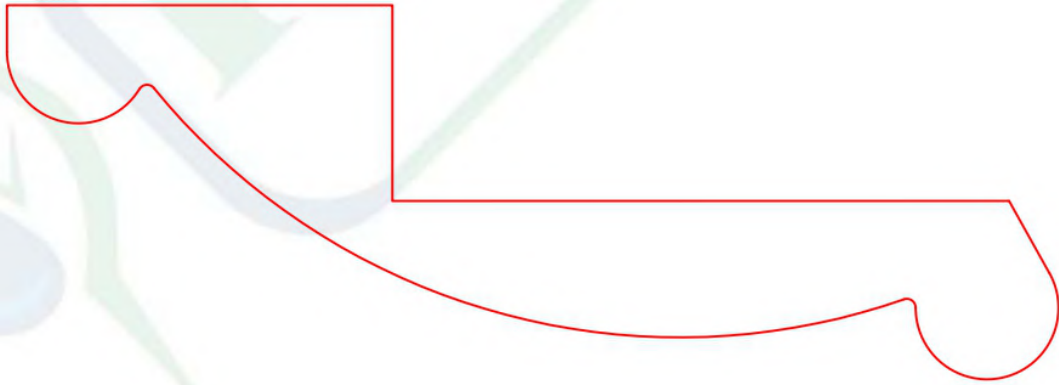
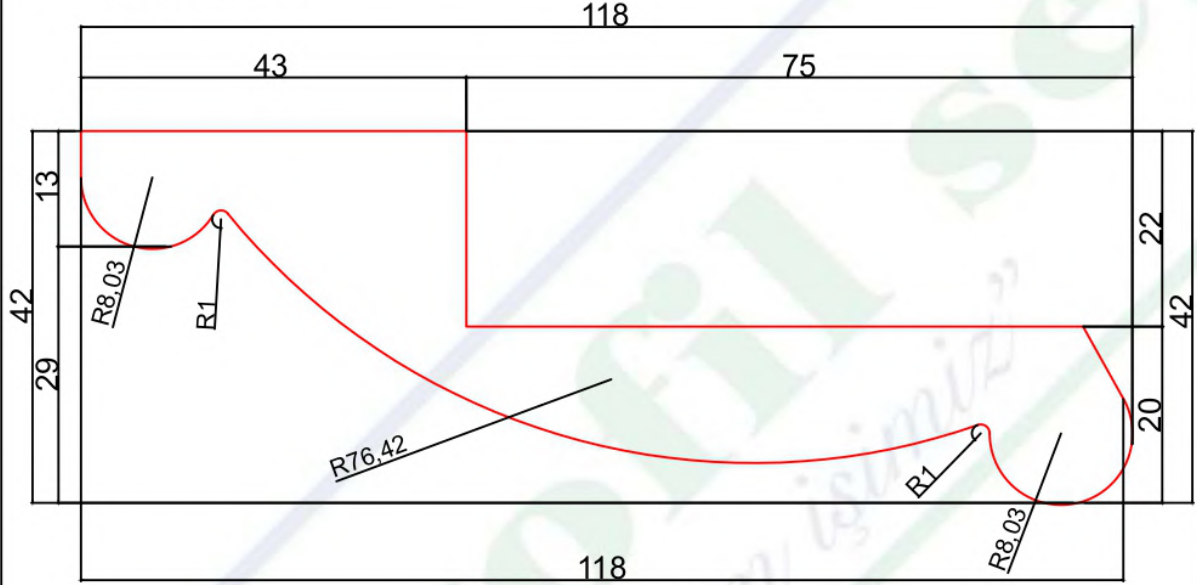

BÖLÜM SORUMLUSU NEJDET ALTINTOPRAK	BU ÇİZİM PROFİLSE - SİLAS ORMAN ÜRÜNLERİ'NE AİTTİR. İZINSİZ ÇOĞALTILMAMAK VE KOPYA EDİLMEKEMEK ŞARTI İLE İZİN VERİLMİŞTİR.	PVC ENİ : MDF MİKTARI : PLAKADAN ÇIKAN :	KSM ÖLÇÜCÜ :	KUTU İÇİ : KUTU İÇİ ADET :
ARGE SORUMLUSU DOĞUKAN DEMİR	THIS DRAWING PROFILE - SİLAS FOREST PRODUCTS WHAT TO DO. UNLOCKED AND COPY NOT ALLOWED WITH THE WRITTEN.	GENEL TOLERANS : PROFİL BOY TOLERANSI :	MATERİYAL MM MDF	TARİH / DATE 04.02.2019

42 mm Profiles

PROFİLSE - SİLAS ORMAN ÜRÜNLERİ

KAĞIT ÜZERİNDEN ÖLÇÜ ALMAYINIZ !!!

Don't measurate on paper.

ÜRÜN KODU : 42*44

(Product Code)

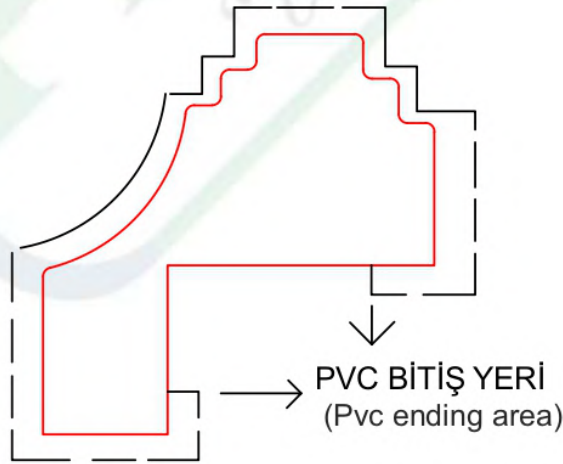
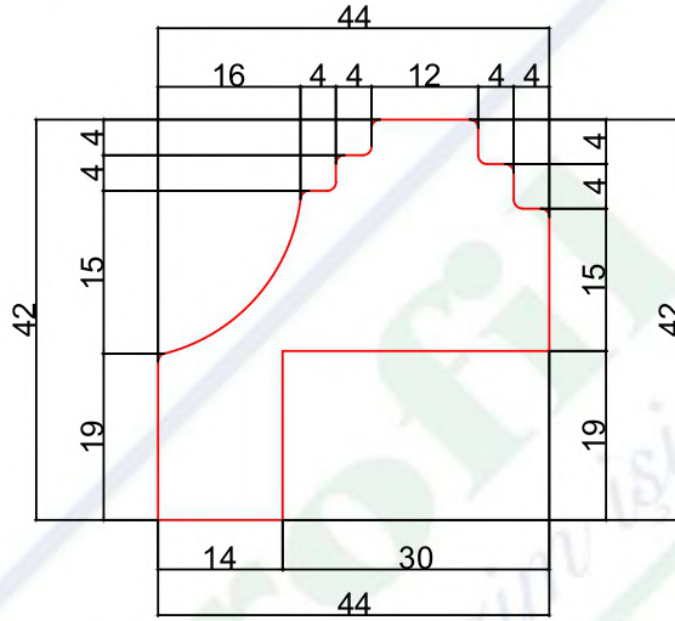

BÖLÜM SORUMLUSU NEJDET ALTINTOPRAK	BU ÇİZİM PROFİLSE - SİLAS ORMAN ÜRÜNLERİ'NE AİTTİR. İZINSİZ ÇOĞALTILMAMAK VE KOPYA EDİLMEMEK ŞARTI İLE İZİN VERİLMİŞTİR.	PVC ENİ : MDF MİKTARI : PLAKADAN ÇIKAN :	KSM ÖLÇÜCÜ :	KUTU İÇİ : KUTU İÇİ ADET :
ARGE SORUMLUSU DOĞUKAN DEMİR	THIS DRAWING PROFILE - SİLAS FOREST PRODUCTS WHAT TO DO. UNLOCKED AND COPY NOT ALLOWED WITH THE WRITTEN.	GENEL TOLERANS : PROFİL BOY TOLERANSI :	MATERİYAL MM MDF	TARİH / DATE 25.01.2019

42 mm Profiles

PROFİLSE - SİLAS ORMAN ÜRÜNLERİ

KAĞIT ÜZERİNDEN ÖLÇÜ ALMAYINIZ !!!

ÜRÜN KODU : 42*50

Don't measurate on paper.

(Product Code)

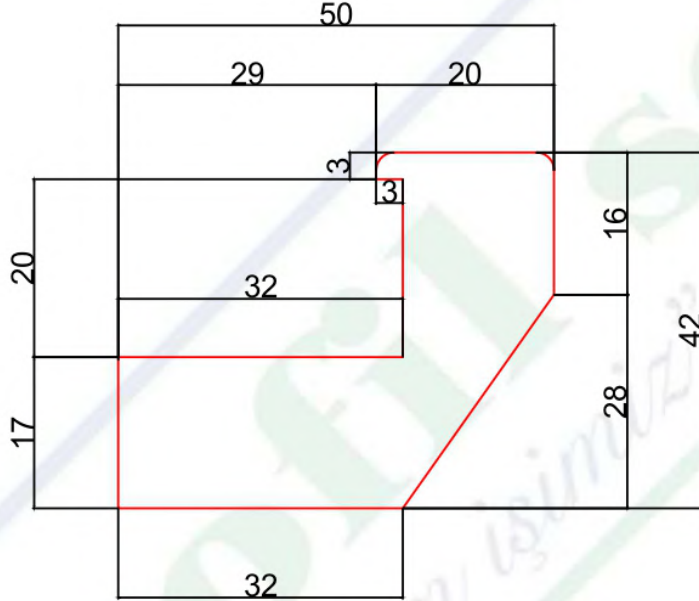

(Pvc ending area)

PVC BİTİŞ YERİ

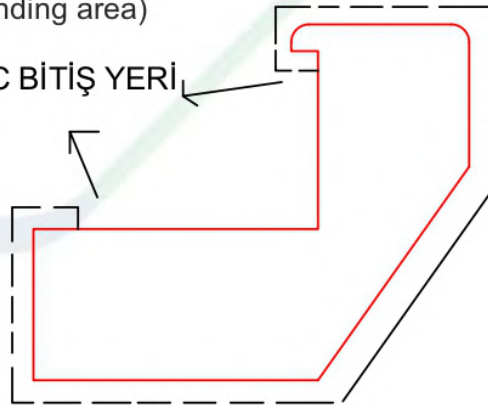

BÖLÜM SORUMLUSU NEJDET ALTINTOPRAK	BU ÇİZİM PROFİLSE - SİLAS ORMAN ÜRÜNLERİ'NE AİTTİR. İZİNSİZ ÇOĞALTILMAMAK VE KOPYA EDİLMEMEK ŞARTI İLE İZİN VERİLMİŞTİR.	PVC ENİ : MDF MİKTARI : PLAKADAN ÇIKAN :	KSM ÖLÇÜCÜ :	KUTU İÇİ : KUTU İÇİ ADET :
ARGE SORUMLUSU DOĞUKAN DEMİR	THIS DRAWING PROFILE - SİLAS FOREST PRODUCTS WHAT TO DO. UNLOCKED AND COPY NOT ALLOWED WITH THE WRITTEN.	GENEL TOLERANS : PROFL BOY TOLERANSI :	MATERİYAL MM MDF	TARİH / DATE 10.10.2018

43 mm Profiles

PROFİLSE - SİLAS ORMAN ÜRÜNLERİ

KAĞIT ÜZERİNDEN ÖLÇÜ ALMAYINIZ !!!
Don't measure on paper.

ÜRÜN KODU : 43*70
(Product Code)

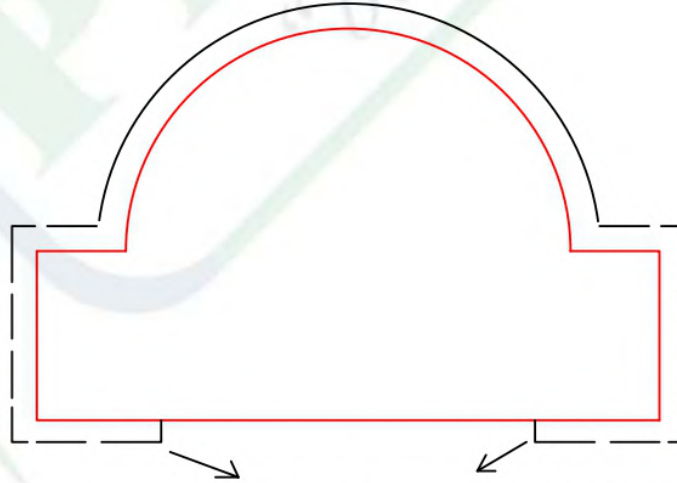
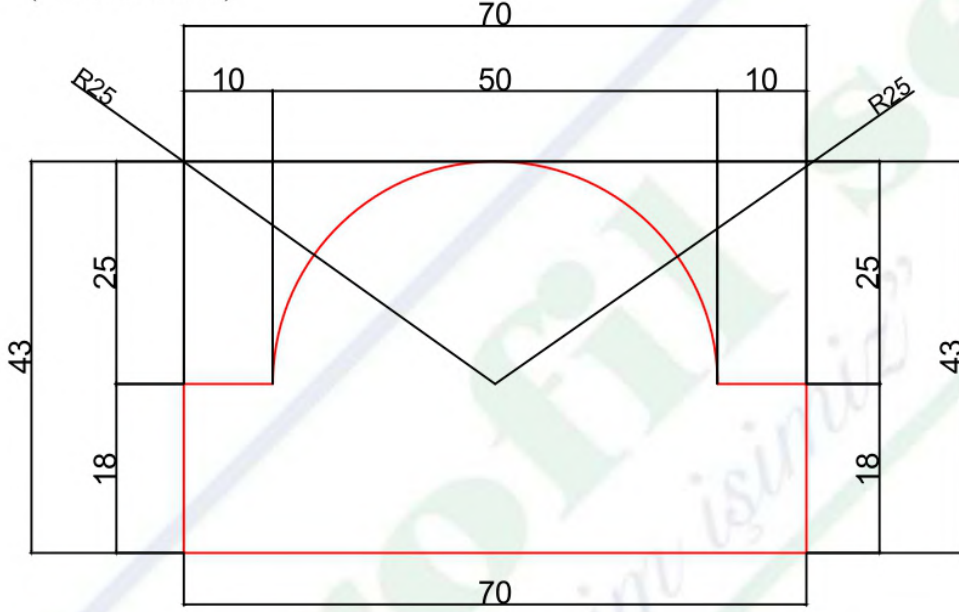

PVC BİTİŞ YERİ (Pvc ending area)

BÖLÜM SORUMLUSU NEJDET ALTINTOPRAK	BU ÇİZİM PROFİLSE - SİLAS ORMAN ÜRÜNLERİ'NE AİTTİR. İZİNSİZ ÇOĞALTILMAMAK VE KOPYA EDİLMEMEK ŞARTI İLE İZİN VERİLMİŞTİR.	PVC ENİ : MDF MİKTARI : PLAKADAN ÇIKAN :	KSM ÖLÇÜCÜ :	KUTU İÇİ : KUTU İÇİ ADET :
ARGE SORUMLUSU DOĞUKAN DEMİR	THIS DRAWING PROFILE - SİLAS FOREST PRODUCTS WHAT TO DO. UNLOCKED AND COPY NOT ALLOWED WITH THE WRITTEN.	GENEL TOLERANS : PROFİL BOY TOLERANSI :	MATERIAL : MM MDF	TARİH / DATE 03.04.2019

43 mm Profiles

PROFİLSE - SİLAS ORMAN ÜRÜNLERİ

KAĞIT ÜZERİNDEN ÖLÇÜ ALMAYINIZ !!!
Don't measure on paper.

ÜRÜN KODU : 43*60

(Product Code)

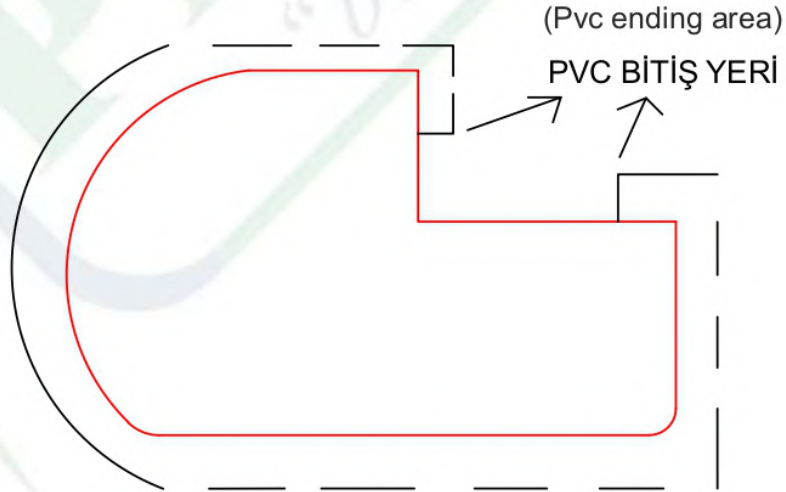
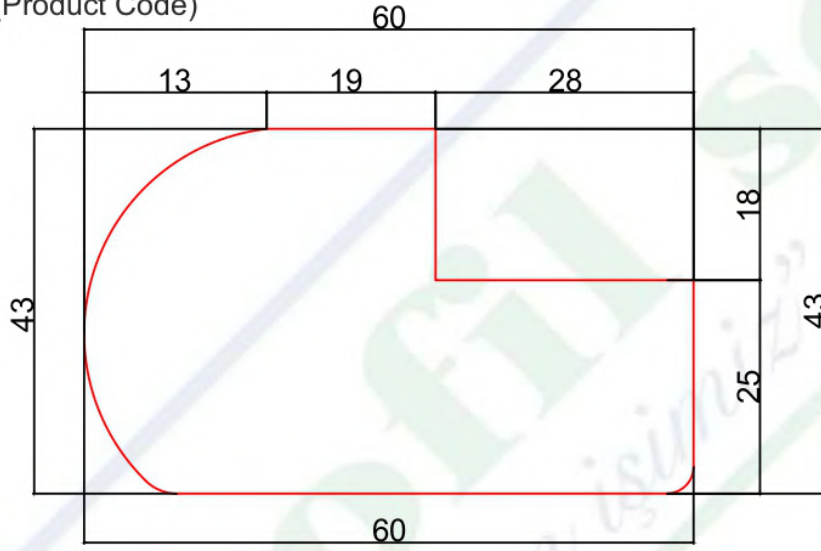

BÖLÜM SORUMLUSU NEJDET ALTINTOPRAK	BU ÇİZİM PROFİLSE - SİLAS ORMAN ÜRÜNLERİ'NE AİTTİR. İZİNSİZ ÇOĞALTILMAMAK VE KOPYA EDİLMEK ŞARTI İLE İZİN VERİLMİŞTİR.	PVC ENİ : MDF MİKTARI : PLAKADAN ÇIKAN :	KSM ÖLÇÜCÜ :	KUTU İÇİ : KUTU İÇİ ADET :
ARGE SORUMLUSU DOĞUKAN DEMİR	THIS DRAWING PROFILE - SİLAS FOREST PRODUCTS WHAT TO DO. UNLOCKED AND COPY NOT ALLOWED WITH THE WRITTEN.	GENEL TOLERANS : PROFL BOY TOLERANSI :	MATERİYAL MM MDF	TARİH / DATE 04.10.2018

43 mm Profiles

PROFİLSE - SİLAS ORMAN ÜRÜNLERİ

KAĞIT ÜZERİNDEN ÖLÇÜ ALMAYINIZ !!!

ÜRÜN KODU : 43*70
(Product Code)

Don't measurate on paper.

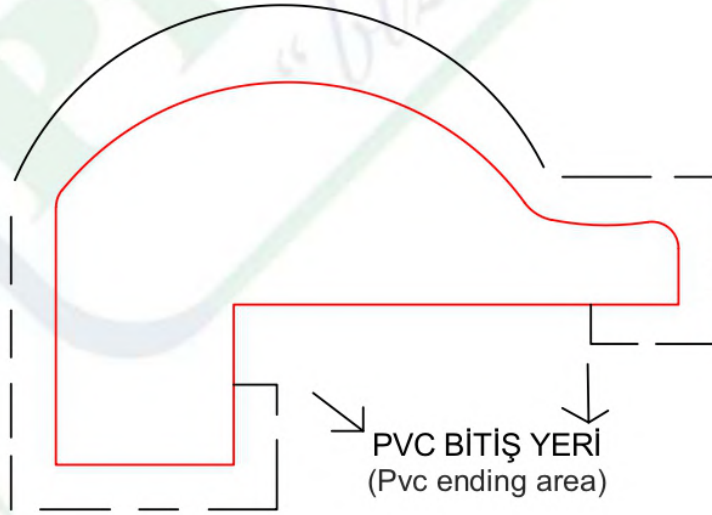
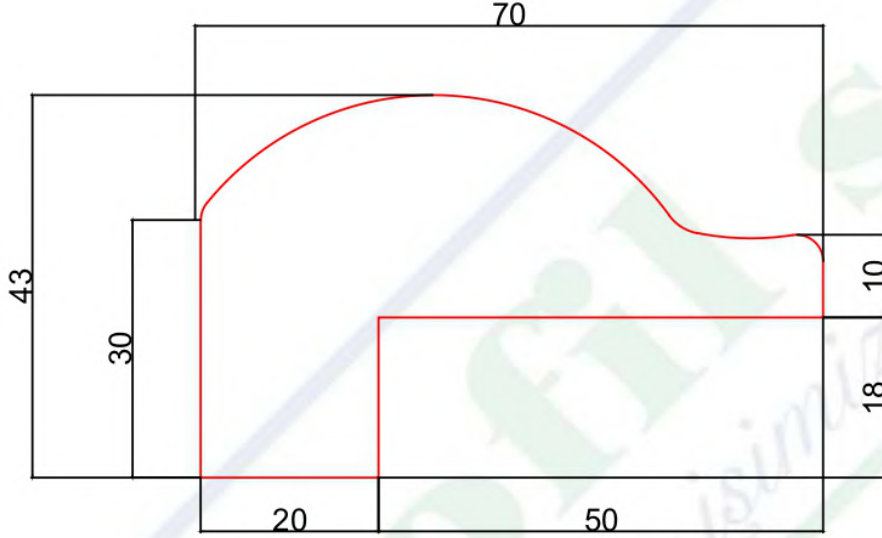

BÖLÜM SORUMLUSU NEJDET ALTINTOPRAK	BU ÇİZİM PROFİLSE - SİLAS ORMAN ÜRÜNLERİ'NE AİTTİR. İZINSİZ ÇOĞALTILMAMAK VE KOPYA EDİLMEMEK ŞARTI İLE İZİN VERİLMİŞTİR.	PVC ENİ : MDF MİKTARI : PLAKADAN ÇIKAN :	KSM ÖLÇÜCÜ :	KUTU İÇİ : KUTU İÇİ ADET :
ARGE SORUMLUSU DOĞUKAN DEMİR	THIS DRAWING PROFILE - SİLAS FOREST PRODUCTS WHAT TO DO. UNLOCKED AND COPY NOT ALLOWED WITH THE WRITTEN.	GENEL TOLERANS : PROFİL BOY TOLERANSI :	MATERİYAL MM MDF	TARİH / DATE 10.10.2018

43 mm Profiles

PROFİLSE - SİLAS ORMAN ÜRÜNLERİ

KAĞIT ÜZERİNDEN ÖLÇÜ ALMAYINIZ !!!
Don't measure on paper.

ÜRÜN KODU : 43*77
(Product Code)

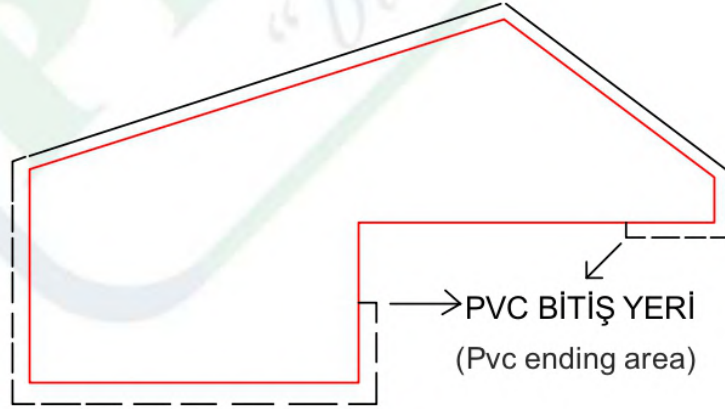
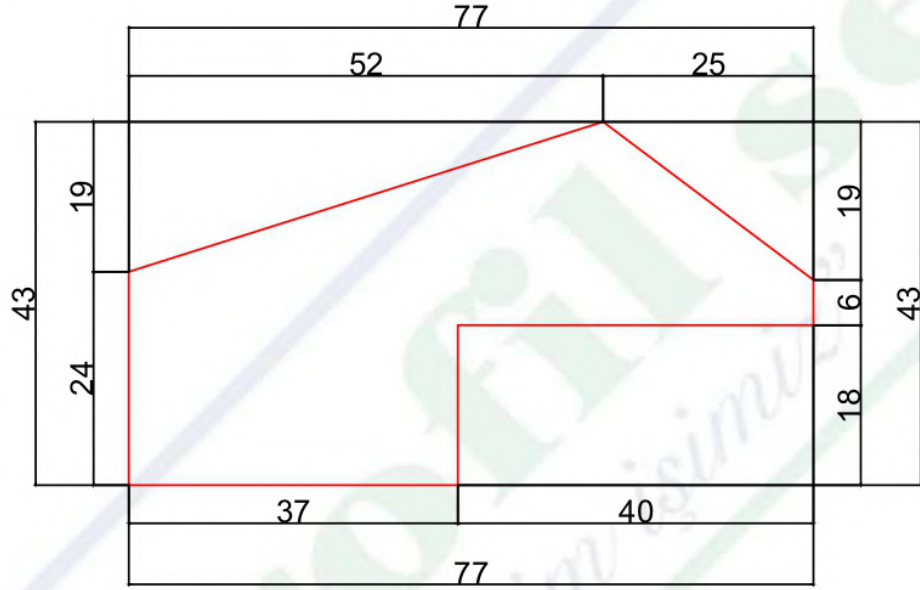

BÖLÜM SORUMLUSU NEJDET ALTINTOPRAK	BU ÇİZİM PROFİLSE - SİLAS ORMAN ÜRÜNLERİ'NE AİTTİR. İZINSİZ ÇOĞALTILMAMAK VE KOPYA EDİLMEKEMEK ŞARTI İLE İZİN VERİLMİŞTİR.	PVC ENİ : MDF MİKTARI : PLAKADAN ÇIKAN :	KSM ÖLÇÜCÜ :	KUTU İÇİ : KUTU İÇİ ADET :
ARGE SORUMLUSU DOĞUKAN DEMİR	THIS DRAWING PROFILE - SİLAS FOREST PRODUCTS WHAT TO DO. UNLOCKED AND COPY NOT ALLOWED WITH THE WRITTEN.	GENEL TOLERANS : PROFİL BOY TOLERANSI :	MATERİYAL MM MDF	TARİH / DATE 08.03.2019

44 mm Profiles

PROFİLSE - SİLAS ORMAN ÜRÜNLERİ

KAĞIT ÜZERİNDEN ÖLÇÜ ALMAYINIZ !!!

Don't measurate on paper.

ÜRÜN KODU : 44*60

(Product Code)

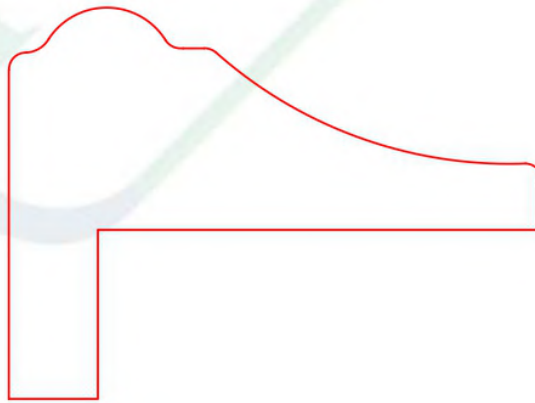
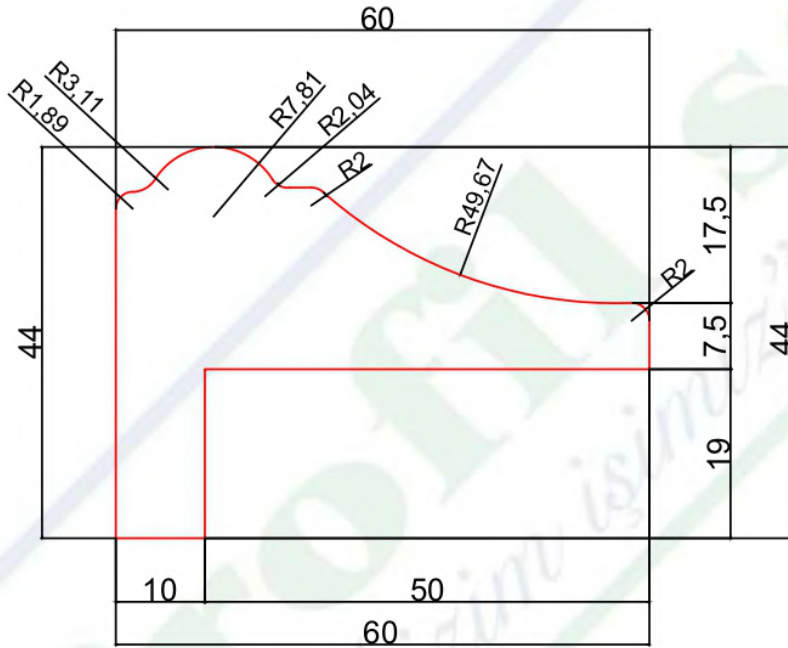

BÖLÜM SORUMLUSU NEJDET ALTINTOPRAK	BU ÇİZİM PROFİLSE - SİLAS ORMAN ÜRÜNLERİ'NE AİTTİR. İZİNSİZ ÇOĞALTILMAMAK VE KOPYA EDİLMEKEMEK ŞARTI İLE İZİN VERİLMİŞTİR.	PVC ENİ : MDF MİKTARI : PLAKADAN ÇIKAN :	KSM ÖLÇÜCÜ :	KUTU İÇİ : KUTU İÇİ ADET :
ARGE SORUMLUSU DOĞUKAN DEMİR	THIS DRAWING PROFILE - SİLAS FOREST PRODUCTS WHAT TO DO. UNLOCKED AND COPY NOT ALLOWED WITH THE WRITTEN.	GENEL TOLERANS : PROFİL BOY TOLERANSI :	MATERİYAL MM MDF	TARİH / DATE 04.02.2019

44 mm Profiles

PROFİLSE - SİLAS ORMAN ÜRÜNLERİ

KAĞIT ÜZERİNDEN ÖLÇÜ ALMAYINIZ !!!

Don't measurate on paper.

ÜRÜN KODU : 44*44
(Product Code)

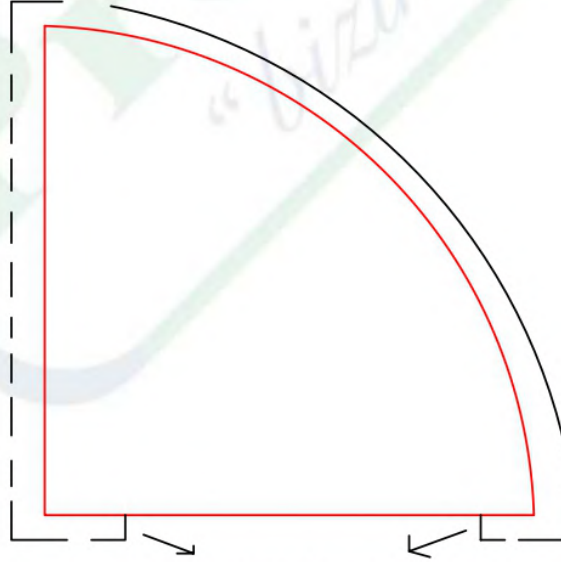
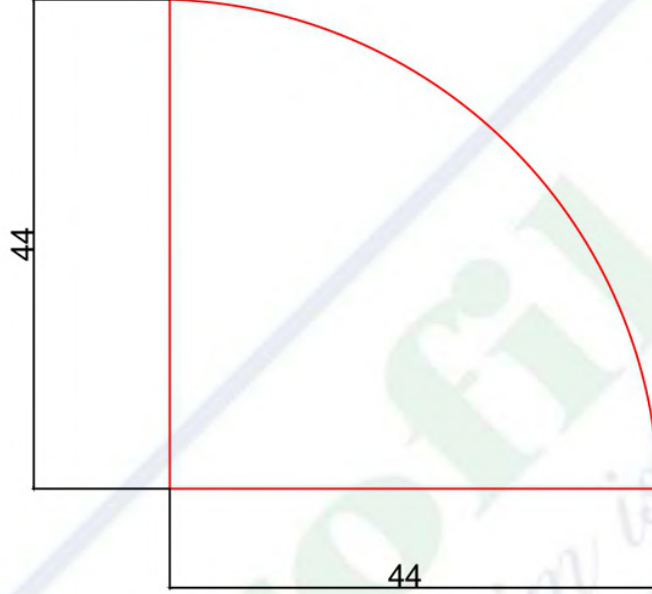

PVC BİTİŞ YERİ
(Pvc ending area)

BÖLÜM SORUMLUSU NEJDET ALTINTOPRAK	BU ÇİZİM PROFİLSE - SİLAS ORMAN ÜRÜNLERİ 'NE AİTTİR. İZINSİZ ÇOĞALTILMAMAK VE KOPYA EDİLMEMEK ŞARTI İLE İZİN VERİLMİŞTİR.	PVC ENİ : MDF MİKTARI : PLAKADAN ÇIKAN :	KSM ÖLÇÜCÜ :	KUTU İÇİ : KUTU İÇİ ADET :
ARGE SORUMLUSU DOĞUKAN DEMİR	THIS DRAWING PROFILE - SİLAS FOREST PRODUCTS WHAT TO DO. UNLOCKED AND COPY NOT ALLOWED WITH THE WRITTEN.	GENEL TOLERANS : PROFİL BOY TOLERANSI :	MATERİYAL MM MDF	TARİH / DATE 04.10.2018

44 mm Profiles

PROFİLSE - SİLAS ORMAN ÜRÜNLERİ

KAĞIT ÜZERİNDEN ÖLÇÜ ALMAYINIZ !!!
Don't measure on paper.

ÜRÜN KODU : 44*50
(Product Code)

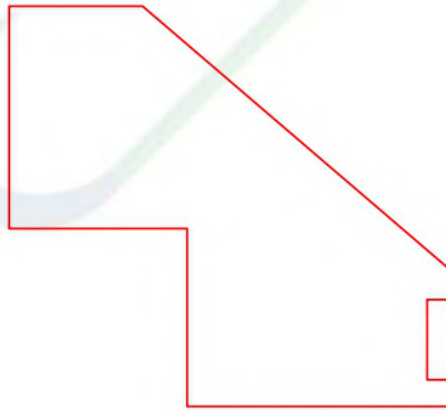
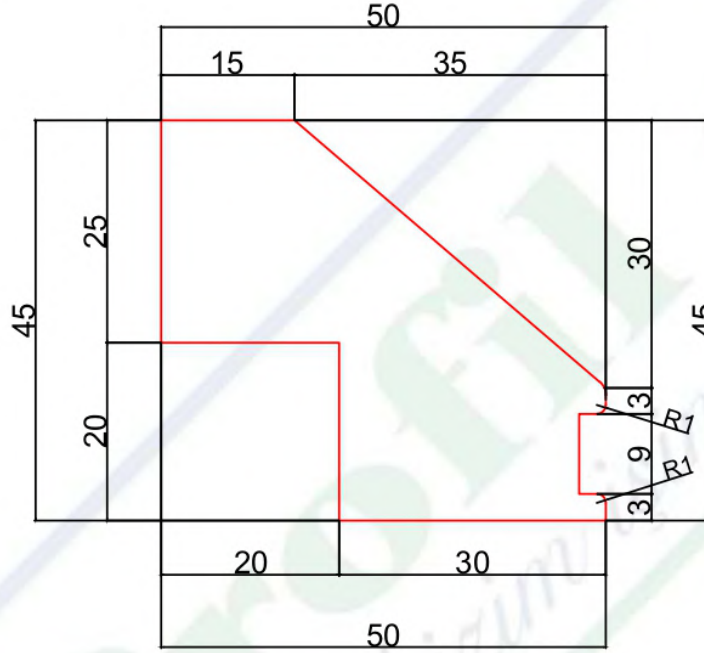

BÖLÜM SORUMLUSU NEJDET ALTINTOPRAK	BU ÇİZİM PROFİLSE - SİLAS ORMAN ÜRÜNLERİ'NE AİTTİR. İZİNSİZ ÇOĞALTILMAMAK VE KOPYA EDİLMEKEMEK ŞARTI İLE İZİN VERİLMİŞTİR.	MDF MIKTARI : TABAKADAN ÇIKAN :	PVC ÖLÇÜSÜ :	KUTU İÇİ : KUTU İÇİ ADET :
ARGE SORUMLUSU DOĞUKAN DEMİR	THIS DRAWING PROFILE - SİLAS FOREST PRODUCTS WHAT TO DO. UNLOCKED AND COPY NOT ALLOWED WITH THE WRITTEN.	STANDART PROFİL BOY : PROFİL BOY :	MDF TÜRÜ : MM MDF	TARİH / DATE 20.05.2019

45-47-48 mm Profiles

PROFİLSE - SİLAS ORMAN ÜRÜNLERİ

KAĞIT ÜZERİNDEN ÖLÇÜ ALMAYINIZ !!!

Don't measurate on paper.

ÜRÜN KODU : 45*50

(Product Code)

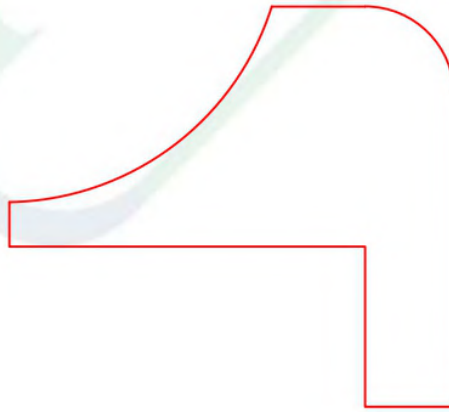
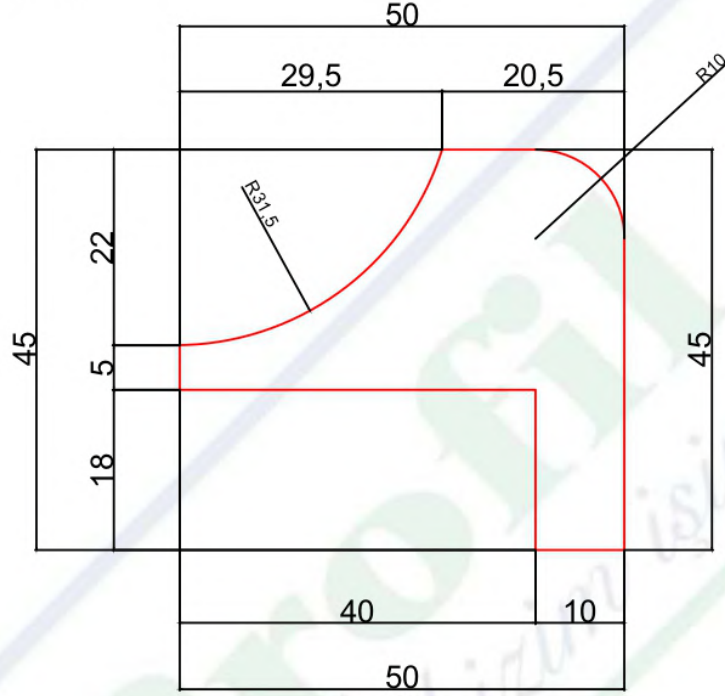

BÖLÜM SORUMLUSU NEJDET ALTINTOPRAK	BU ÇİZİM PROFİLSE - SİLAS ORMAN ÜRÜNLERİ'NE AİTTİR. İZINSİZ ÇOĞALTILMAMAK VE KOPYA EDİLMEMEK ŞARTI İLE İZİN VERİLMİŞTİR.	PVC ENİ : MDF MİKTARI : PLAKADAN ÇIKAN :	KSM ÖLÇÜCÜ :	KUTU İÇİ : KUTU İÇİ ADET :
ARGE SORUMLUSU DOĞUKAN DEMİR	THIS DRAWING PROFILE - SİLAS FOREST PRODUCTS WHAT TO DO. UNLOCKED AND COPY NOT ALLOWED WITH THE WRITTEN.	GENEL TOLERANS : PROFİL BOY TOLERANSI :	MATERIAL MM MDF	TARİH / DATE 17.12.2018

45-47-48 mm Profiles

PROFİLSE - SİLAS ORMAN ÜRÜNLERİ

KAĞIT ÜZERİNDEN ÖLÇÜ ALMAYINIZ !!!

Don't measure on paper.

ÜRÜN KODU : 47*47

(Product Code)

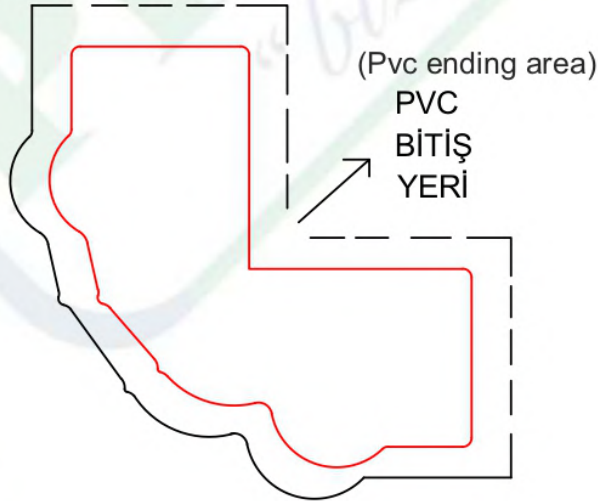
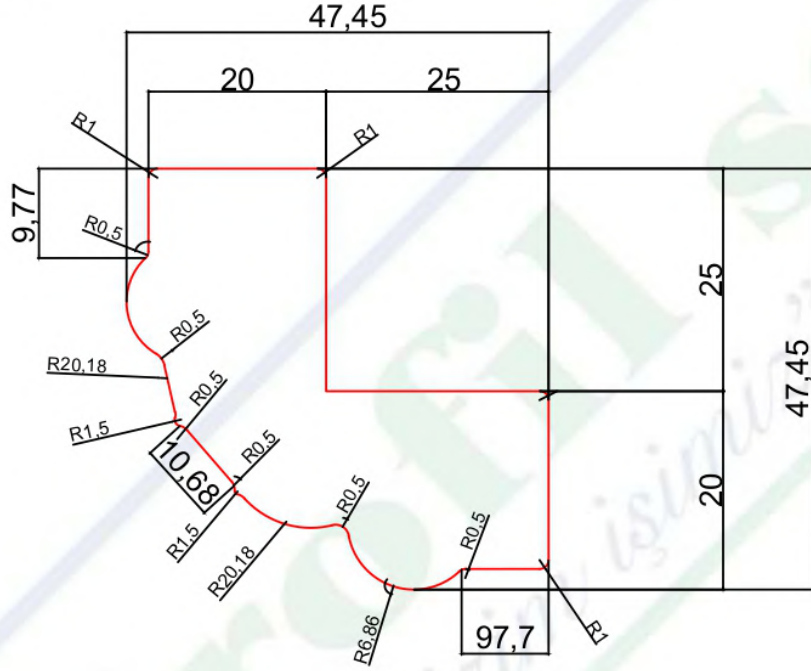

BÖLÜM SORUMLUSU NEJDET ALTINTOPRAK	BU ÇİZİM PROFİLSE - SİLAS ORMAN ÜRÜNLERİ'NE AİTTİR. İZINSİZ ÇOĞALTILMAMAK VE KOPYA EDİLMEKEMEK ŞARTI İLE İZİN VERİLMİŞTİR.	PVC ENİ : MDF MIKTARI : PLAKADAN ÇIKAN :	KSM ÖLÇÜCÜ :	KUTU İÇİ : KUTU İÇİ ADET :
ARGE SORUMLUSU DOĞUKAN DEMİR	THIS DRAWING PROFILE - SİLAS FOREST PRODUCTS WHAT TO DO. UNLOCKED AND COPY NOT ALLOWED WITH THE WRITTEN.	GENEL TOLERANS : PROFİL BOY TOLERANSI :	MATERIAL MM MDF	TARİH / DATE 10.12.2018

45-47-48 mm Profiles

PROFİLSE - SİLAS ORMAN ÜRÜNLERİ

KAĞIT ÜZERİNDEN ÖLÇÜ ALMAYINIZ !!!
Don't measurate on paper.

ÜRÜN KODU : 48*48

(Product Code)

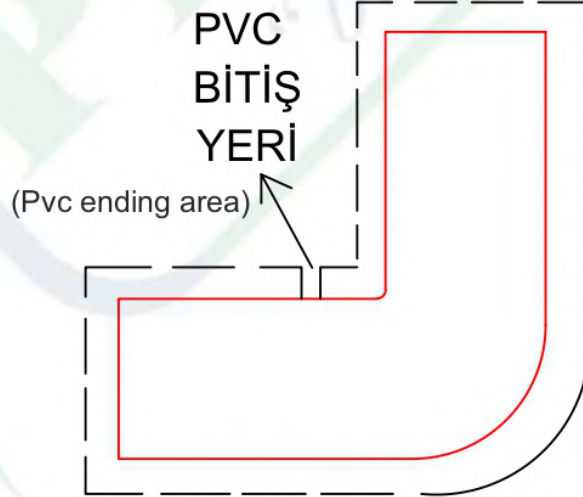
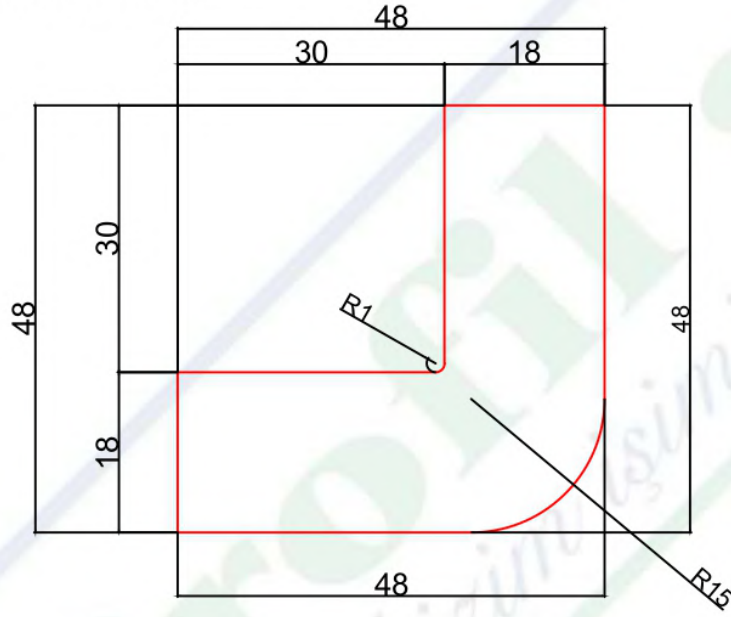

BÖLÜM SORUMLUSU NEJDET ALTINTOPRAK	BU ÇİZİM PROFİLSE - SİLAS ORMAN ÜRÜNLERİ'NE AİTTİR. İZINSİZ ÇOĞALTILMAMAK VE KOPYA EDİLMEMEK ŞARTI İLE İZİN VERİLMİŞTİR.	PVC ENİ : MDF MİKTARI : PLAKADAN ÇIKAN :	KSM ÖLÇÜCÜ :	KUTU İÇİ : KUTU İÇİ ADET :
ARGE SORUMLUSU DOĞUKAN DEMİR	THIS DRAWING PROFILE - SİLAS FOREST PRODUCTS WHAT TO DO. UNLOCKED AND COPY NOT ALLOWED WITH THE WRITTEN.	GENEL TOLERANS : PROFİL BOY TOLERANSI :	MATERIAL MM MDF	TARİH / DATE 10.04.2019

50 mm Profiles

PROFİLSE - SİLAS ORMAN ÜRÜNLERİ

KAĞIT ÜZERİNDEN ÖLÇÜ ALMAYINIZ !!!

Don't measurate on paper.

ÜRÜN KODU : 50*60

(Product Code)

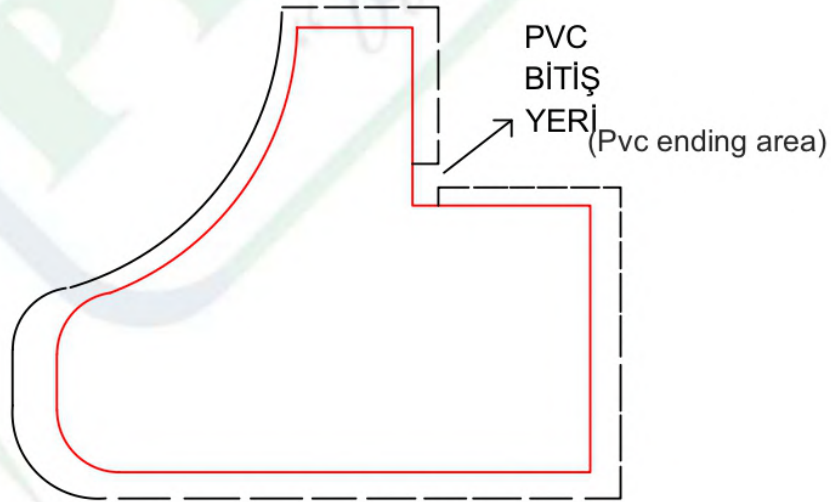
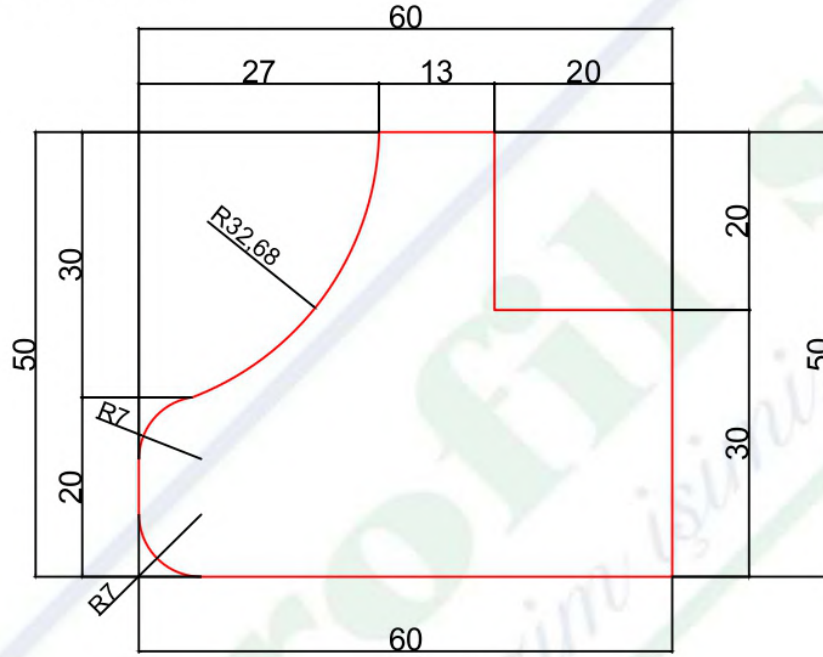

BÖLÜM SORUMLUSU NEJDET ALTINTOPRAK	BU ÇİZİM PROFİLSE - SİLAS ORMAN ÜRÜNLERİ'NE AITTİR. İZİNSİZ ÇOĞALTILMAMAK VE KOPYA EDİLMEMEK ŞARTI İLE İZİN VERİLMİŞTİR.	MDF MİKTARI : TABAKADAN ÇIKAN :	PVC ÖLÇÜSÜ :	KUTU İÇİ : KUTU İÇİ ADET :
ARGE SORUMLUSU DOĞUKAN DEMİR	THIS DRAWING PROFILE - SİLAS FOREST PRODUCTS WHAT TO DO. UNLOCKED AND COPY NOT ALLOWED WITH THE WRITTEN.	STANDART PROFİL BOY : PROFİL BOY :	MDF TÜRÜ : MM MDF	TARİH / DATE 20.05.2019

50 mm Profiles

PROFİLSE - SİLAS ORMAN ÜRÜNLERİ

ÜRÜN KODU : 50*79
(Product Code)

KAĞIT ÜZERİNDEN ÖLÇÜ ALMAYINIZ !!!
Don't measure on paper.

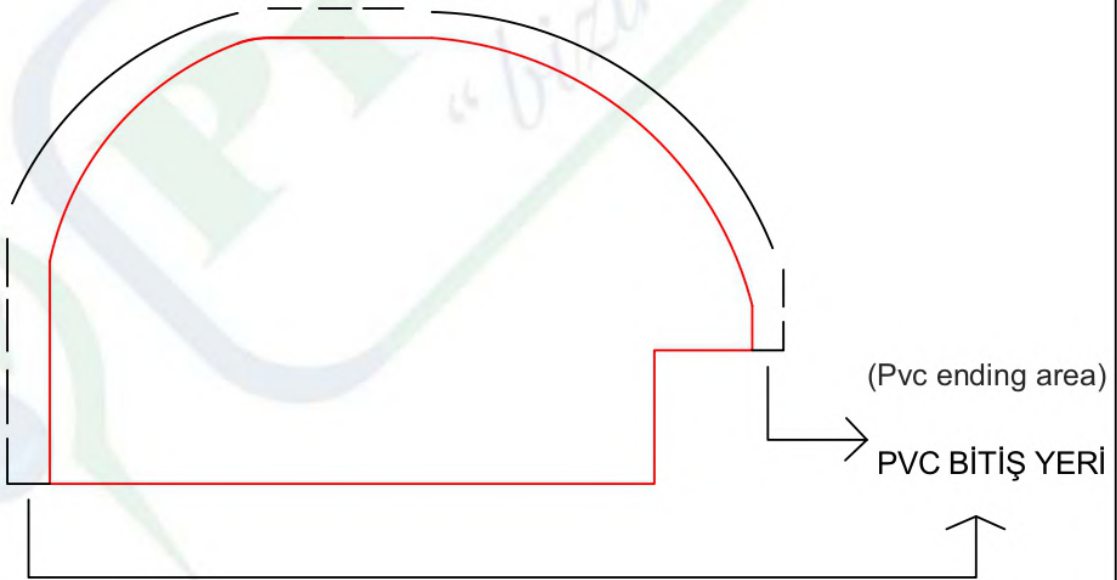
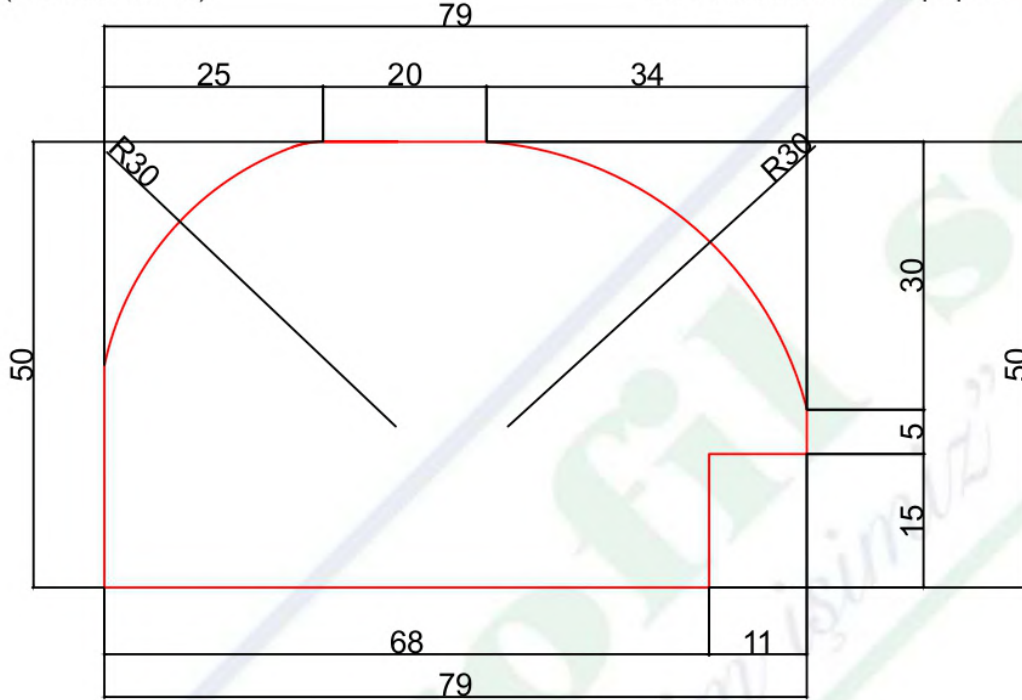

BÖLÜM SORUMLUSU NEJDET ALTINTOPRAK	BU ÇİZİM PROFİLSE - SİLAS ORMAN ÜRÜNLERİ'NE AİTTİR. İZINSİZ ÇOĞALTILMAMAK VE KOPYA EDİLMEMEK ŞARTI İLE İZİN VERİLMİŞTİR.	PVC ENİ : MDF MİKTARI : PLAKADAN ÇIKAN :	KSM ÖLÇÜCÜ :	KUTU İÇİ : KUTU İÇİ ADET :
ARGE SORUMLUSU DOĞUKAN DEMİR	THIS DRAWING PROFILE - SILAS FOREST PRODUCTS WHAT TO DO. UNLOCKED AND COPY NOT ALLOWED WITH THE WRITTEN.	GENEL TOLERANS : PROFİL BOY TOLERANSI :	MATERİYAL MM MDF	TARİH / DATE 19.11.2018

50 mm Profiles

PROFİLSE - SİLAS ORMAN ÜRÜNLERİ

KAĞIT ÜZERİNDEN ÖLÇÜ ALMAYINIZ !!!

Don't measurate on paper.

ÜRÜN KODU : 50*50
(Product Code)

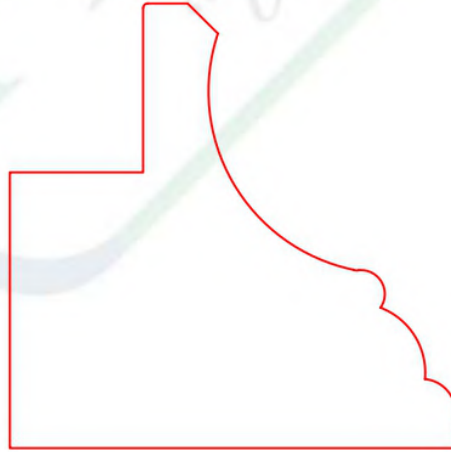
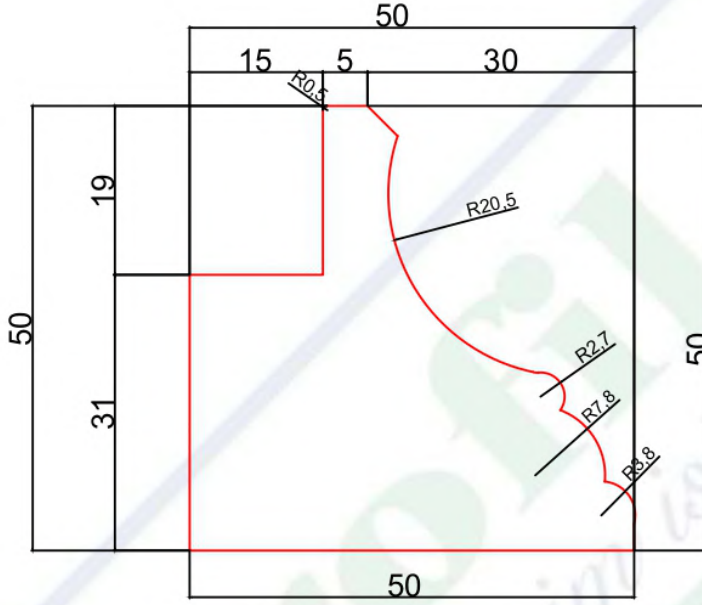

BÖLÜM SORUMLUSU NEJDET ALTINTOPRAK	BU ÇİZİM PROFİLSE - SİLAS ORMAN ÜRÜNLERİ'NE AİTTİR. İZINSİZ ÇOĞALTILMAMAK VE KOPYA EDİLMEKEMEK ŞARTI İLE İZİN VERİLMİŞTİR.	PVC ENİ : MDF MİKTARI : PLAKADAN ÇIKAN :	KSM ÖLÇÜCÜ :	KUTU İÇİ : KUTU İÇİ ADET :
ARGE SORUMLUSU DOĞUKAN DEMİR	THIS DRAWING PROFILE - SİLAS FOREST PRODUCTS WHAT TO DO. UNLOCKED AND COPY NOT ALLOWED WITH THE WRITTEN.	GENEL TOLERANS : PROFL BOY TOLERANSI :	MATERİYAL MM MDF	TARİH / DATE 25.12.2018

50 mm Profiles

PROFİLSE - SİLAS ORMAN ÜRÜNLERİ

KAĞIT ÜZERİNDEN ÖLÇÜ ALMAYINIZ !!!

Don't measurate on paper.

ÜRÜN KODU : 50*100

(Product Code)

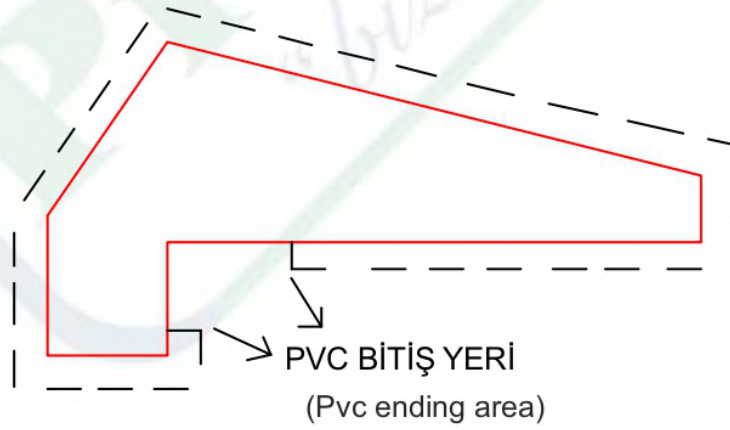
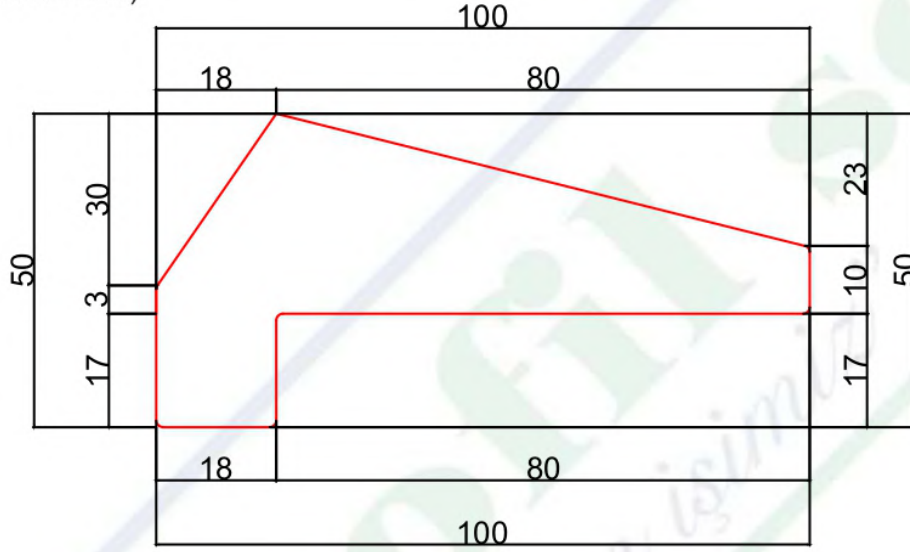

BÖLÜM SORUMLUSU NEJDET ALTINTOPRAK	BU ÇİZİM PROFİLSE - SİLAS ORMAN ÜRÜNLERİ'NE AİTTİR. İZİNSİZ ÇOĞALTILMAMAK VE KOPYA EDİLMEMEK ŞARTI İLE İZİN VERİLMİŞTİR.	PVC ENİ : MDF MİKTARI : PLAKADAN ÇIKAN :	KSM ÖLÇÜCÜ :	KUTU İÇİ : KUTU İÇİ ADET :
ARGE SORUMLUSU DOĞUKAN DEMİR	THIS DRAWING PROFILE - SİLAS FOREST PRODUCTS WHAT TO DO. UNLOCKED AND COPY NOT ALLOWED WITH THE WRITTEN.	GENEL TOLERANS : PROFİL BOY TOLERANSI :	MATERİYAL MM MDF	TARİH / DATE 04.10.2018

50 mm Profiles

PROFİLSE - SİLAS ORMAN ÜRÜNLERİ

KAĞIT ÜZERİNDEN ÖLÇÜ ALMAYINIZ !!!
Don't measurate on paper.

ÜRÜN KODU : 50*115
(Product Code)

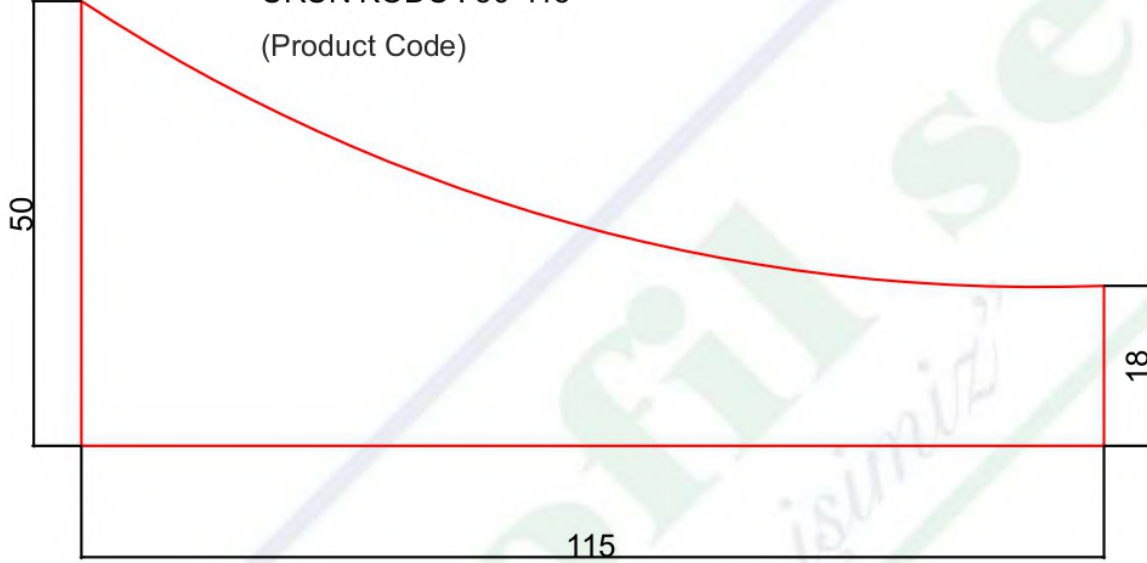

PVC BİTİŞ YERİ
(Pvc ending area)

BÖLÜM SORUMLUSU NEJDET ALTINTOPRAK	BU ÇİZİM PROFİLSE - SİLAS ORMAN ÜRÜNLERİ'NE AİTTİR. İZINSİZ ÇOĞALTILMAMAK VE KOPYA EDİLMEMEK ŞARTI İLE İZİN VERİLMİŞTİR.	PVC ENİ : MDF MİKTARI : PLAKADAN ÇIKAN :	KSM ÖLÇÜCÜ :	KUTU İÇİ : KUTU İÇİ ADET :
ARGE SORUMLUSU DOĞUKAN DEMİR	THIS DRAWING PROFILE - SİLAS FOREST PRODUCTS WHAT TO DO. UNLOCKED AND COPY NOT ALLOWED WITH THE WRITTEN.	GENEL TOLERANS : PROFİL BOY TOLERANSI :	MATERİYAL MM MDF	TARİH / DATE 12.11.2018

50 mm Profiles

PROFİLSE - SİLAS ORMAN ÜRÜNLERİ

KAĞIT ÜZERİNDEN ÖLÇÜ ALMAYINIZ !!!
Don't measure on paper.

ÜRÜN KODU : 50*120
(Product Code)



PVC BİTİŞ YERİ
(Pvc ending area)

BÖLÜM SORUMLUSU NEJDET ALTINTOPRAK	BU ÇİZİM PROFİLSE - SİLAS ORMAN ÜRÜNLERİ'NE AİTTİR. İZINSİZ ÇOĞALTILMAMAK VE KOPYA EDİLMEK ŞARTI İLE İZİN VERİLMİŞTİR.	PVC ENİ : MDF MİKTARI : PLAKADAN ÇIKAN :	KSM ÖLÇÜCÜ :	KUTU İÇİ : KUTU İÇİ ADET :
ARGE SORUMLUSU DOĞUKAN DEMİR	THIS DRAWING PROFILE - SİLAS FOREST PRODUCTS WHAT TO DO. UNLOCKED AND COPY NOT ALLOWED WITH THE WRITTEN.	GENEL TOLERANS : PROFİL BOY TOLERANSI :	MATERİYAL MM MDF	TARİH / DATE 12.11.2018

50 mm Profiles

PROFİLSE - SİLAS ORMAN ÜRÜNLERİ

KAĞIT ÜZERİNDEN ÖLÇÜ ALMAYINIZ !!!

Don't measurate on paper.

ÜRÜN KODU : 50*80
(Product Code)

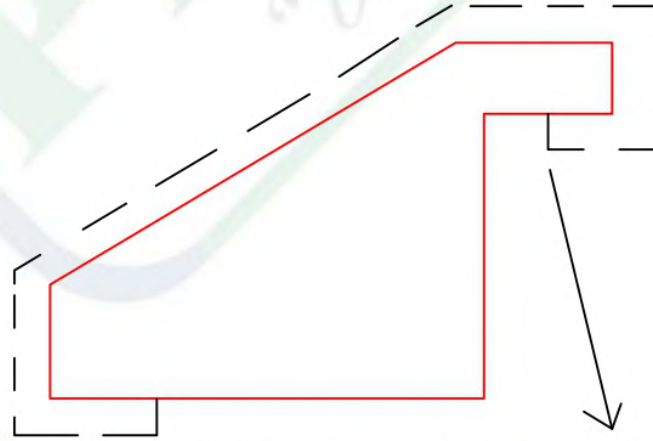
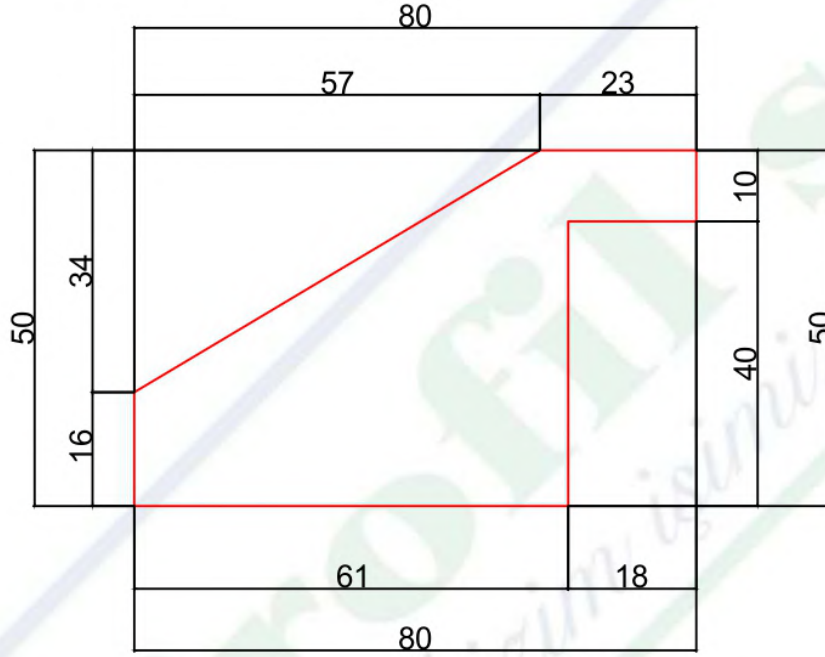

PVC BİTİŞ YERİ
(Pvc ending area)

BÖLÜM SORUMLUSU NEJDET ALTINTOPRAK	BU ÇİZİM PROFİLSE - SİLAS ORMAN ÜRÜNLERİ'NE AİTTİR. İZİNSİZ ÇOĞALTILMAMAK VE KOPYA EDİLMEMEK ŞARTI İLE İZİN VERİLMİŞTİR.	PVC ENİ : MDF MİKTARI : PLAKADAN ÇIKAN :	KSM ÖLÇÜCÜ :	KUTU İÇİ : KUTU İÇİ ADET :
ARGE SORUMLUSU DOĞUKAN DEMİR	THIS DRAWING PROFILE - SİLAS FOREST PRODUCTS WHAT TO DO. UNLOCKED AND COPY NOT ALLOWED WITH THE WRITTEN.	GENEL TOLERANS : PROFİL BOY TOLERANSI :	MATERİYAL MM MDF	TARİH / DATE 04.10.2018

50 mm Profiles

PROFİLSE - SİLAS ORMAN ÜRÜNLERİ

KAĞIT ÜZERİNDEN ÖLÇÜ ALMAYINIZ !!!

ÜRÜN KODU: 50*50 D
(Product Code)

Don't measurate on paper.

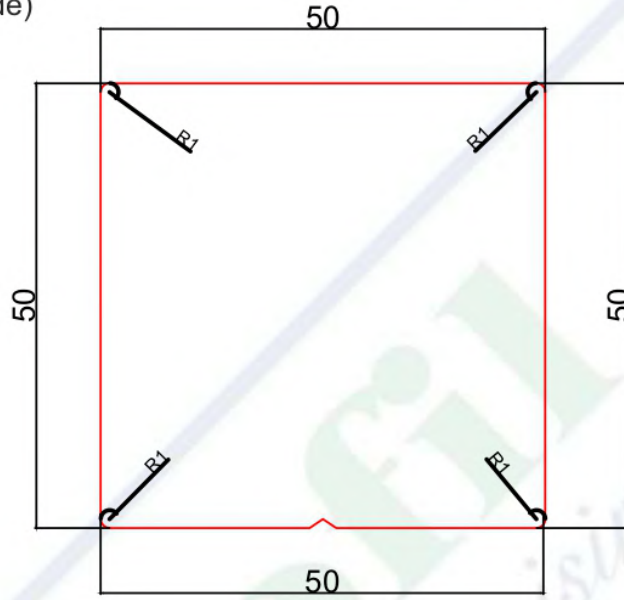

PVC BİTİŞ YERİ
(Pvc ending area)

BÖLÜM SORUMLUSU NEJDET ALTINTOPRAK	BU ÇİZİM PROFİLSE - SİLAS ORMAN ÜRÜNLERİ'NE AİTTİR. İZİNSİZ ÇOĞALTILMAMAK VE KOPYA EDİLMEKEMEK ŞARTI İLE İZİN VERİLMİŞTİR.	PVC ENİ : MDF MİKTARI : PLAKADAN ÇIKAN :	KSM ÖLÇÜCÜ :	KUTU İÇİ : KUTU İÇİ ADET :
ARGE SORUMLUSU DOĞUKAN DEMİR	THIS DRAWING PROFILE - SILAS FOREST PRODUCTS WHAT TO DO. UNLOCKED AND COPY NOT ALLOWED WITH THE WRITTEN.	GENEL TOLERANS : PROFL BOY TOLERANSI :	MATERİAL MM MDF	TARİH / DATE 27.09.2018

50 mm Profiles

PROFİLSE - SİLAS ORMAN ÜRÜNLERİ

KAĞIT ÜZERİNDEN ÖLÇÜ ALMAYINIZ !!!

ÜRÜN KODU: 50*50 K

Don't measurate on paper.

(Product Code)

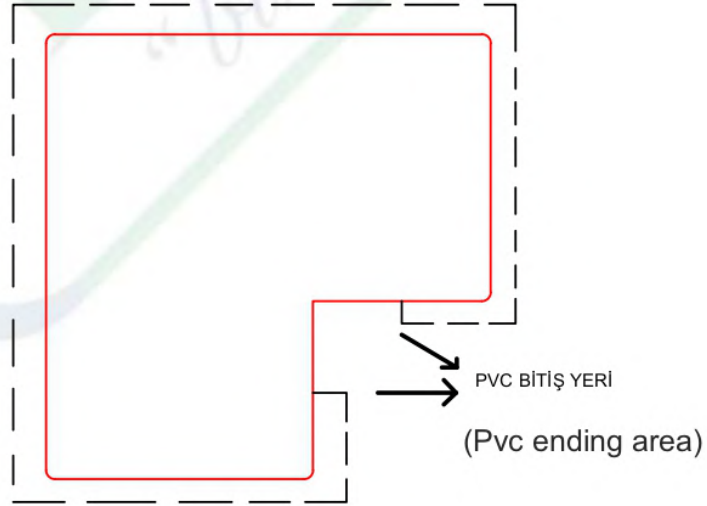
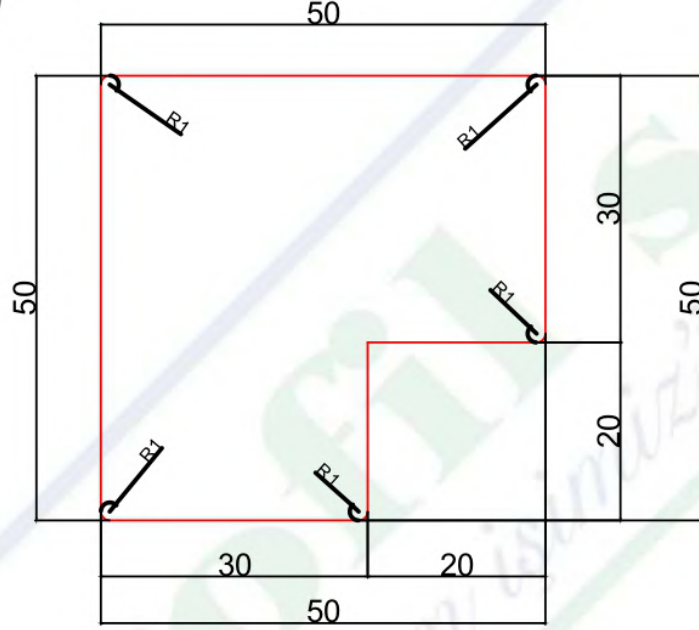

BÖLÜM SORUMLUSU NEJDET ALTINTOPRAK	BU ÇİZİM PROFİLSE - SİLAS ORMAN ÜRÜNLERİ'NE AİTTİR. İZINSİZ ÇOĞALTILMAMAK VE KOPYA EDİLMEMEK ŞARTI İLE İZİN VERİLMİŞTİR.	PVC ENİ : MDF MİKTARI : PLAKADAN ÇIKAN :	KSM ÖLÇÜCÜ :	KUTU İÇİ : KUTU İÇİ ADET :
ARGE SORUMLUSU DOĞUKAN DEMİR	THIS DRAWING PROFILE - SİLAS FOREST PRODUCTS WHAT TO DO. UNLOCKED AND COPY NOT ALLOWED WITH THE WRITTEN.	GENEL TOLERANS : PROFL BOY TOLERANSI :	MATERİYAL MM MDF	TARİH / DATE 27.09.2018

54 mm Profiles

PROFİLSE - SİLAS ORMAN ÜRÜNLERİ

KAĞIT ÜZERİNDEN ÖLÇÜ ALMAYINIZ !!!

Don't measure on paper.

ÜRÜN KODU : 54*55

(Product Code)

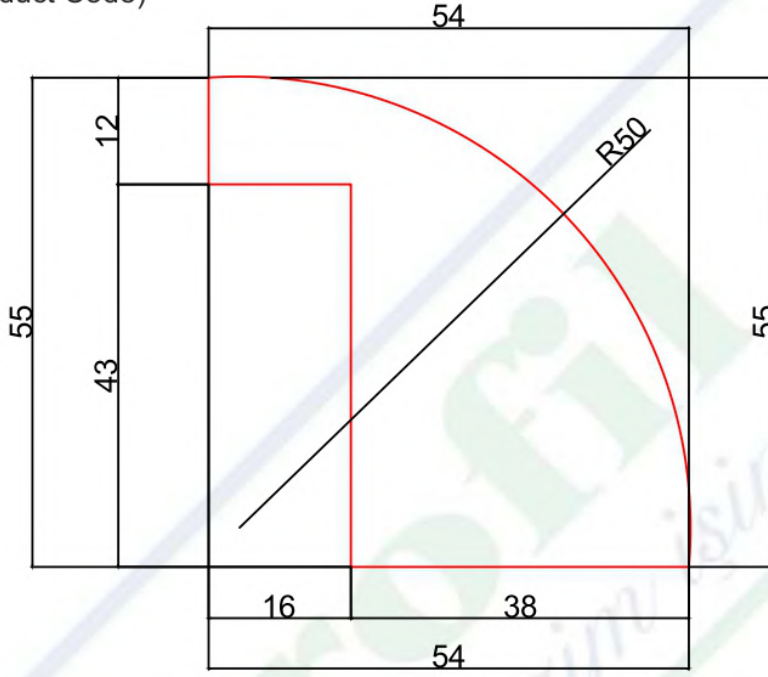

(Pvc ending area)

PVC
BİTİŞ
YERİ

BÖLÜM SORUMLUSU NEJDET ALTINTOPRAK	BU ÇİZİM PROFİLSE - SİLAS ORMAN ÜRÜNLERİ'NE AİTTİR. İZINSİZ ÇOĞALTILMAMAK VE KOPYA EDİLMEMEK ŞARTI İLE İZİN VERİLMİŞTİR.	PVC ENİ : MDF MİKTARI : PLAKADAN ÇIKAN :	KSM ÖLÇÜCÜ :	KUTU İÇİ : KUTU İÇİ ADET :
ARGE SORUMLUSU DOĞUKAN DEMİR	THIS DRAWING PROFILE - SİLAS FOREST PRODUCTS WHAT TO DO. UNLOCKED AND COPY NOT ALLOWED WITH THE WRITTEN.	GENEL TOLERANS : PROFİL BOY TOLERANSI :	MATERİYAL MM MDF	TARİH / DATE 07.02.2019

54 mm Profiles

PROFİLSE - SİLAS ORMAN ÜRÜNLERİ

KAĞIT ÜZERİNDEN ÖLÇÜ ALMAYINIZ !!!
Don't measurate on paper.

ÜRÜN KODU : 54*100
(Product Code)

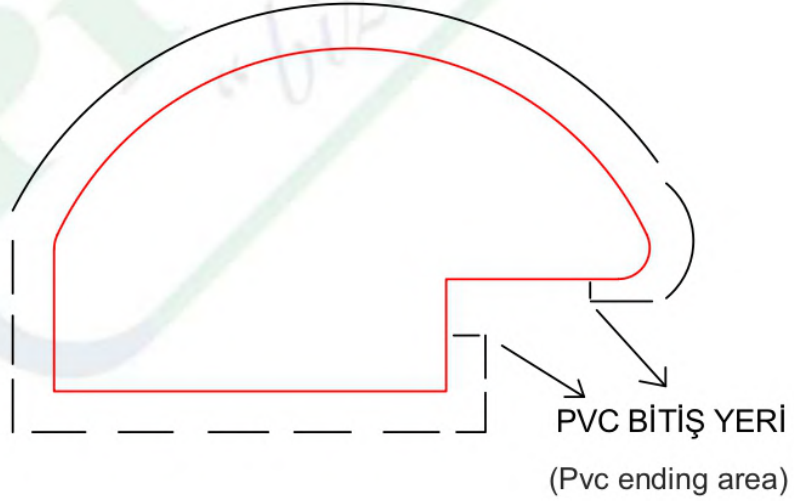
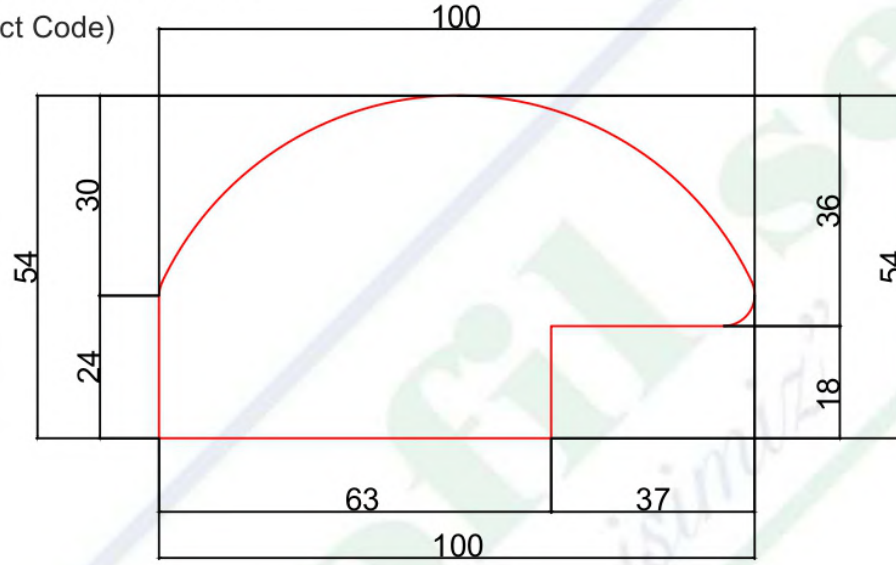

BÖLÜM SORUMLUSU NEJDET ALTINTOPRAK	BU ÇİZİM PROFİLSE - SİLAS ORMAN ÜRÜNLERİ'NE AİTTİR. İZINSİZ ÇOĞALTILMAMAK VE KOPYA EDİLMEKEMEK ŞARTI İLE İZİN VERİLMİŞTİR.	PVC ENİ : MDF MIKTARI : PLAKADAN ÇIKAN :	KSM ÖLÇÜCÜ :	KUTU İÇİ : KUTU İÇİ ADET :
ARGE SORUMLUSU DOĞUKAN DEMİR	THIS DRAWING PROFILE - SİLAS FOREST PRODUCTS WHAT TO DO. UNLOCKED AND COPY NOT ALLOWED WITH THE WRITTEN.	GENEL TOLERANS : PROFİL BOY TOLERANSI :	MATERIAL MM MDF	TARİH / DATE 04.10.2018

60 mm Profiles

PROFİLSE - SİLAS ORMAN ÜRÜNLERİ

KAĞIT ÜZERİNDEN ÖLÇÜ ALMAYINIZ !!!

Don't measurate on paper.

ÜRÜN KODU : 60*60

(Product Code)

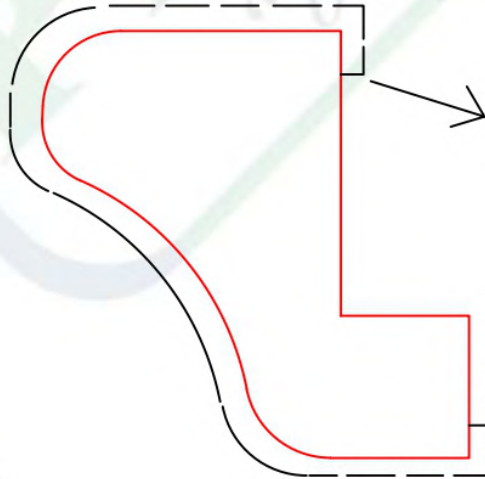
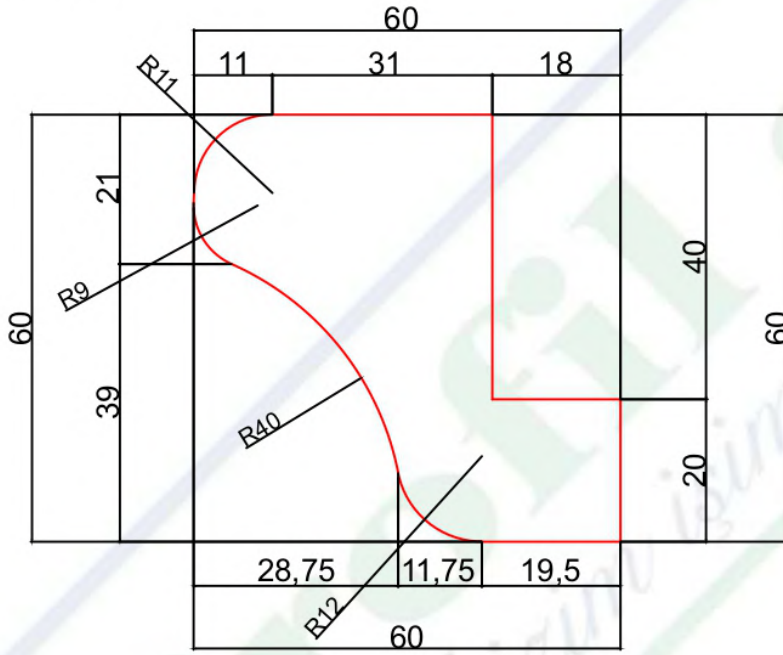

PVC
BİTİŞ
YERİ (Pvc ending area)

BÖLÜM SORUMLUSU NEJDET ALTINTOPRAK	BU ÇİZİM PROFİLSE - SİLAS ORMAN ÜRÜNLERİ'NE AİTTİR. İZİNSİZ ÇOĞALTILMAMAK VE KOPYA EDİLMEMEK ŞARTI İLE İZİN VERİLMİŞTİR.	PVC ENİ : MDF MİKTARI : PLAKADAN ÇIKAN :	KSM ÖLÇÜCÜ :	KUTU İÇİ : KUTU İÇİ ADET :
ARGE SORUMLUSU DOĞUKAN DEMİR	THIS DRAWING PROFILE - SİLAS FOREST PRODUCTS WHAT TO DO. UNLOCKED AND COPY NOT ALLOWED WITH THE WRITTEN.	GENEL TOLERANS : PROFİL BOY TOLERANSI :	MATERIAL MM MDF	TARİH / DATE 24.01.2019

60 mm Profiles

PROFİLSE - SİLAS ORMAN ÜRÜNLERİ

ÜRÜN KODU : 60*60

(Product Code)

KAĞIT ÜZERİNDEN ÖLÇÜ ALMAYINIZ !!!

Don't measurate on paper.

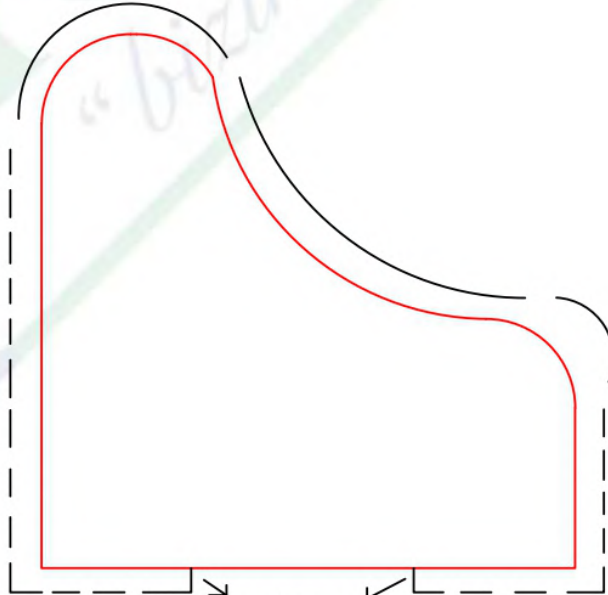
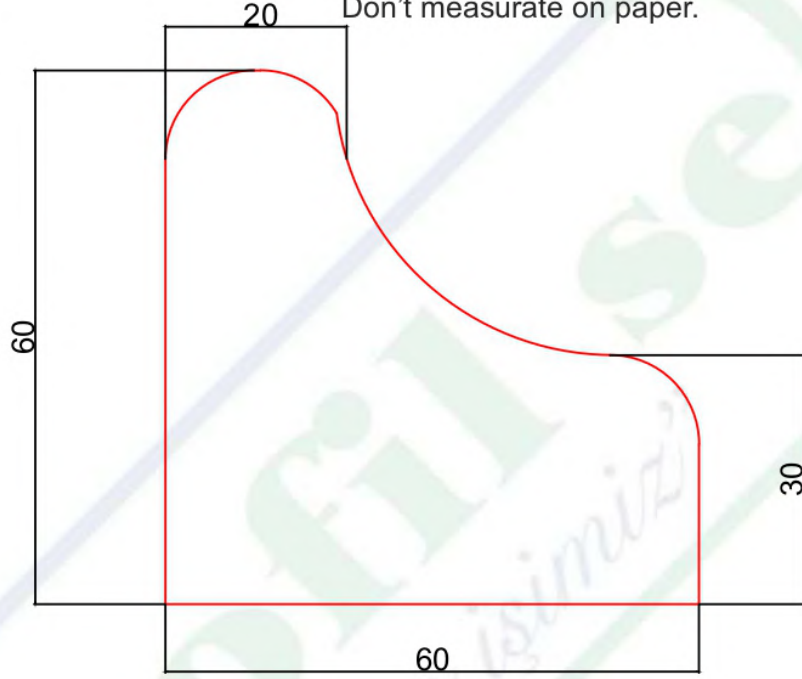

PVC BİTİŞ YERİ
(Pvc ending area)

BÖLÜM SORUMLUSU NEJDET ALTINTOPRAK	BU ÇİZİM PROFİLSE - SİLAS ORMAN ÜRÜNLERİ'NE AITTİR. İZİNSİZ ÇOĞALTILMAMAK VE KOPYA EDİLMEMEK ŞARTI İLE İZİN VERİLMİŞTİR.	PVC ENİ : MDF MİKTARI : PLAKADAN ÇIKAN :	KSM ÖLÇÜCÜ :	KUTU İÇİ : KUTU İÇİ ADET :
ARGE SORUMLUSU DOĞUKAN DEMİR	THIS DRAWING PROFILE - SİLAS FOREST PRODUCTS WHAT TO DO. UNLOCKED AND COPY NOT ALLOWED WITH THE WRITTEN.	GENEL TOLERANS : PROFİL BOY TOLERANSI :	MATERİYAL MM MDF	TARİH / DATE 04.10.2018

60 mm Profiles

PROFİLSE - SİLAS ORMAN ÜRÜNLERİ

KAĞIT ÜZERİNDEN ÖLÇÜ ALMAYINIZ !!!

ÜRÜN KODU : 60*56

(Product Code)

Don't measurate on paper.

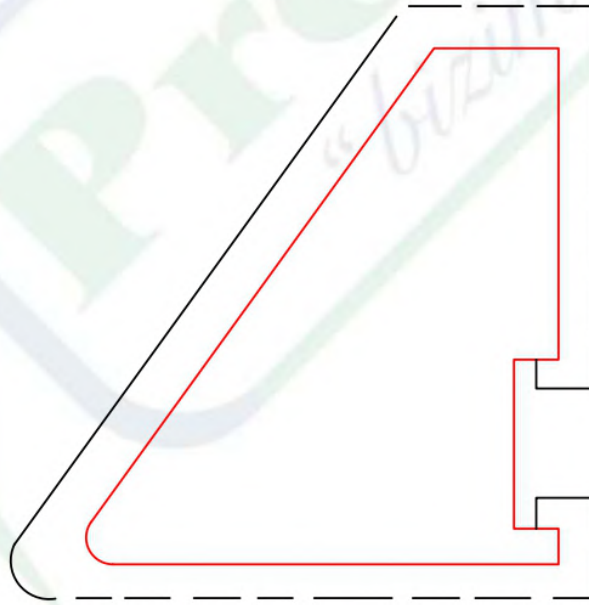
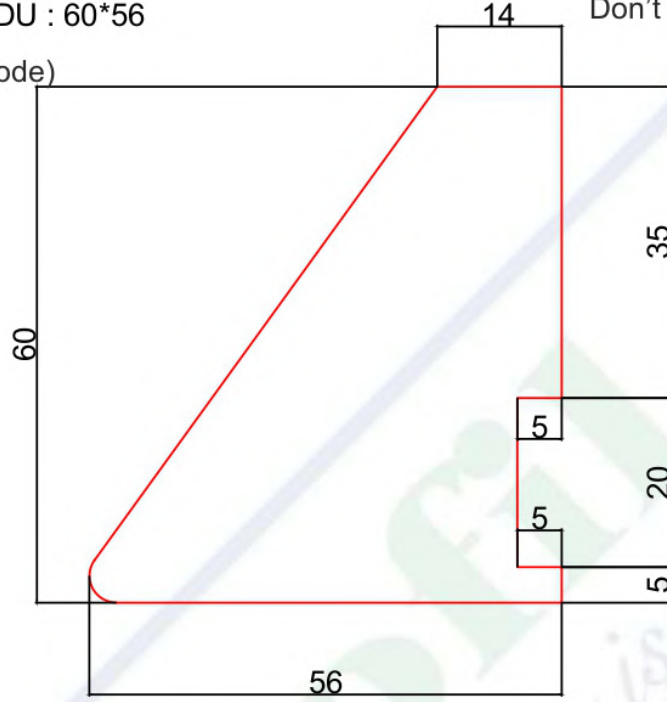

PVC BİTİŞ YERİ

(Pvc ending area)

BÖLÜM SORUMLUSU NEJDET ALTINTOPRAK	BU ÇİZİM PROFİLSE - SİLAS ORMAN ÜRÜNLERİ'NE AİTTİR. İZINSİZ ÇOĞALTILMAMAK VE KOPYA EDİLMEMEK ŞARTI İLE İZİN VERİLMİŞTİR.	PVC ENİ : MDF MİKTARI : PLAKADAN ÇIKAN :	KSM ÖLÇÜCÜ :	KUTU İÇİ : KUTU İÇİ ADET :
ARGE SORUMLUSU DOĞUKAN DEMİR	THIS DRAWING PROFILE - SİLAS FOREST PRODUCTS WHAT TO DO. UNLOCKED AND COPY NOT ALLOWED WITH THE WRITTEN.	GENEL TOLERANS : PROFİL BOY TOLERANSI :	MATERİYAL MM MDF	TARİH / DATE 10.10.2018

60 mm Profiles

PROFİLSE - SİLAS ORMAN ÜRÜNLERİ

KAĞIT ÜZERİNDEN ÖLÇÜ ALMAYINIZ !!!

Don't measure on paper.

ÜRÜN KODU : 60*60

(Product Code)

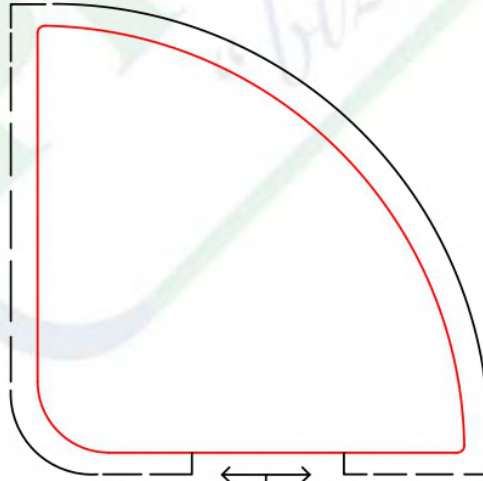
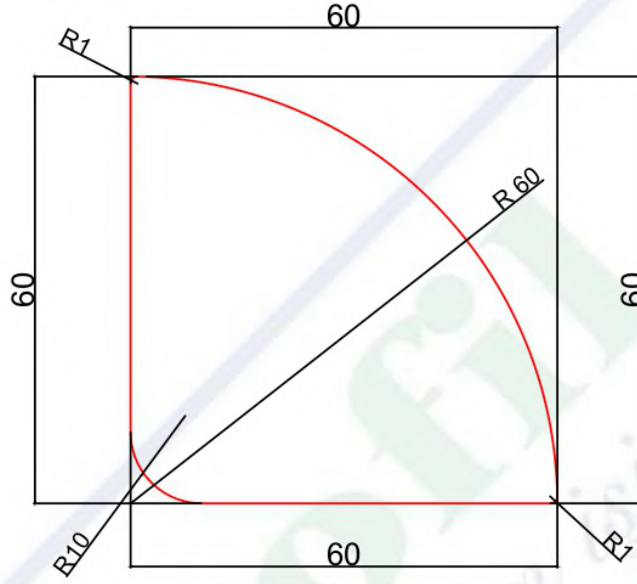

PVC BİTİŞ YERİ (Pvc ending area)

BÖLÜM SORUMLUSU NEJDET ALTINTOPRAK	BU ÇİZİM PROFİLSE - SİLAS ORMAN ÜRÜNLERİ'NE AİTTİR. İZINSİZ ÇOĞALTILMAMAK VE KOPYA EDİLMEMEK ŞARTI İLE İZİN VERİLMİŞTİR.	PVC ENİ : MDF MİKTARI : PLAKADAN ÇIKAN :	KSM ÖLÇÜCÜ :	KUTU İÇİ : KUTU İÇİ ADET :
ARGE SORUMLUSU DOĞUKAN DEMİR	THIS DRAWING PROFILE - SİLAS FOREST PRODUCTS WHAT TO DO. UNLOCKED AND COPY NOT ALLOWED WITH THE WRITTEN.	GENEL TOLERANS : PROFL BOY TOLERANSI :	MATERİYAL MM MDF	TARİH / DATE 10.04.2019

60 mm Profiles

PROFİLSE - SİLAS ORMAN ÜRÜNLERİ

ÜRÜN KODU : 60*60
(Product Code)

KAĞIT ÜZERİNDEN ÖLÇÜ ALMAYINIZ !!!
Don't measure on paper.

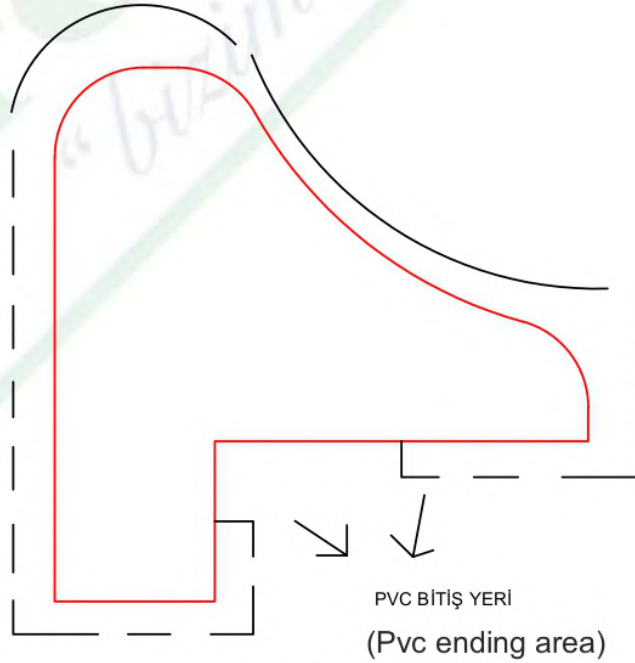
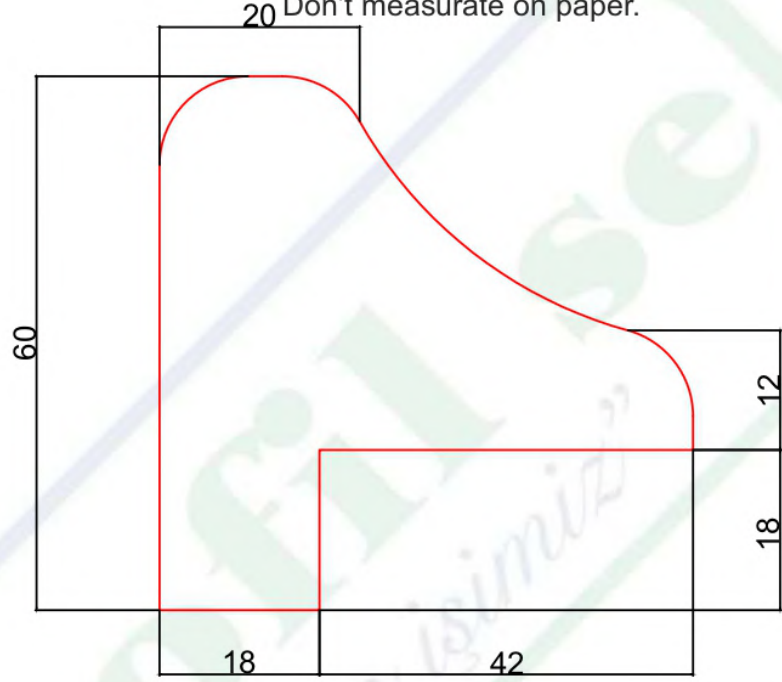

BÖLÜM SORUMLUSU NEJDET ALTINTOPRAK	BU ÇİZİM PROFİLSE - SİLAS ORMAN ÜRÜNLERİ'NE AİTTİR. İZİNSİZ ÇOĞALTILMAMAK VE KOPYA EDİLMEMEK ŞARTI İLE İZİN VERİLMİŞTİR.	PVC ENİ : MDF MİKTARI : PLAKADAN ÇIKAN :	KSM ÖLÇÜCÜ :	KUTU İÇİ : KUTU İÇİ ADET :
ARGE SORUMLUSU DOĞUKAN DEMİR	THIS DRAWING PROFILE - SİLAS FOREST PRODUCTS WHAT TO DO. UNLOCKED AND COPY NOT ALLOWED WITH THE WRITTEN.	GENEL TOLERANS : PROFİL BOY TOLERANSI :	MATERİYAL MM MDF	TARİH / DATE 04.10.2018

60 mm Profiles

PROFİLSE - SİLAS ORMAN ÜRÜNLERİ

KAGIT ÜZERİNDEN ÖLÇÜ ALMAYINIZ !!!
Don't measure on paper.

ÜRÜN KODU : 60*60
(Product Code)

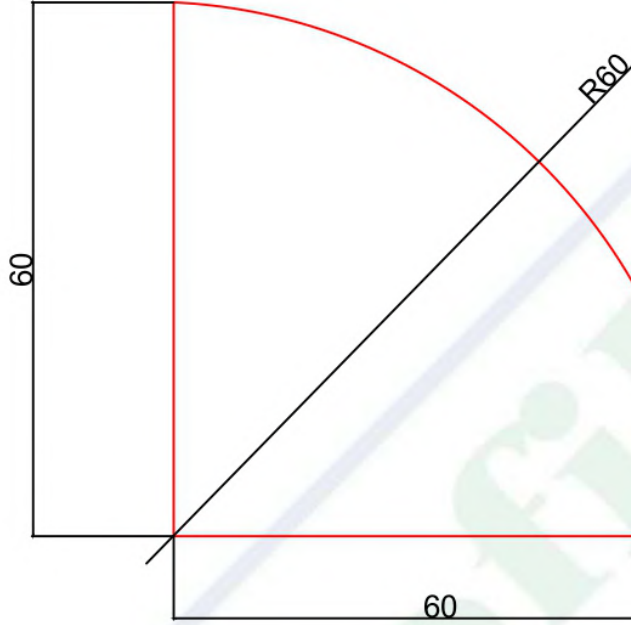

PVC
BİTİŞ
YERİ
(Pvc ending area)

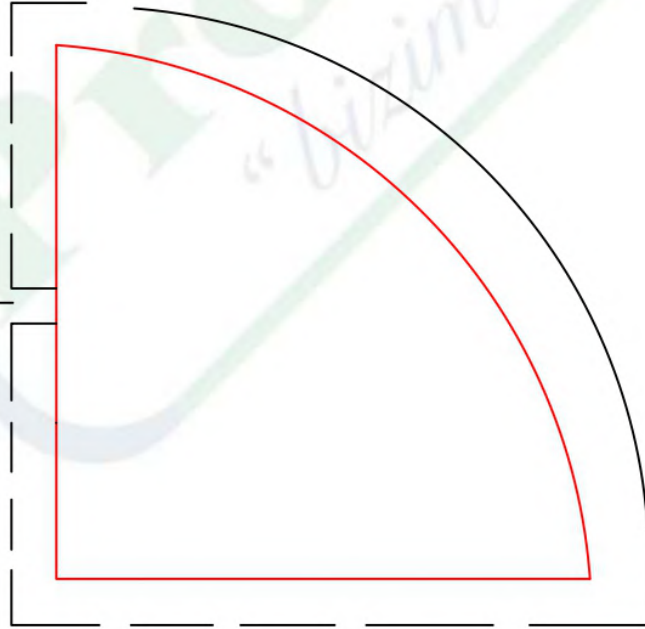

BÖLÜM SORUMLUSU NEJDET ALTINTOPRAK	BU ÇİZİM PROFİLSE - SİLAS ORMAN ÜRÜNLERİ'NE AİTTİR. İZINSİZ ÇOĞALTILMAMAK VE KOPYA EDİLMEK ŞARTI İLE İZİN VERİLMİŞTİR.	PVC ENİ : MDF MİKTARI : PLAKADAN ÇIKAN :	KSM ÖLÇÜCÜ :	KUTU İÇİ : KUTU İÇİ ADET :
ARGE SORUMLUSU DOĞUKAN DEMİR	THIS DRAWING PROFILE - SİLAS FOREST PRODUCTS WHAT TO DO. UNLOCKED AND COPY NOT ALLOWED WITH THE WRITTEN.	GENEL TOLERANS : PROFİL BOY TOLERANSI :	MATERİYAL MM MDF	TARİH / DATE 12.10.2018

60 mm Profiles

PROFİLSE - SİLAS ORMAN ÜRÜNLERİ

KAĞIT ÜZERİNDEN ÖLÇÜ ALMAYINIZ !!!

Don't measurate on paper.

ÜRÜN KODU : 60*90

(Product Code)

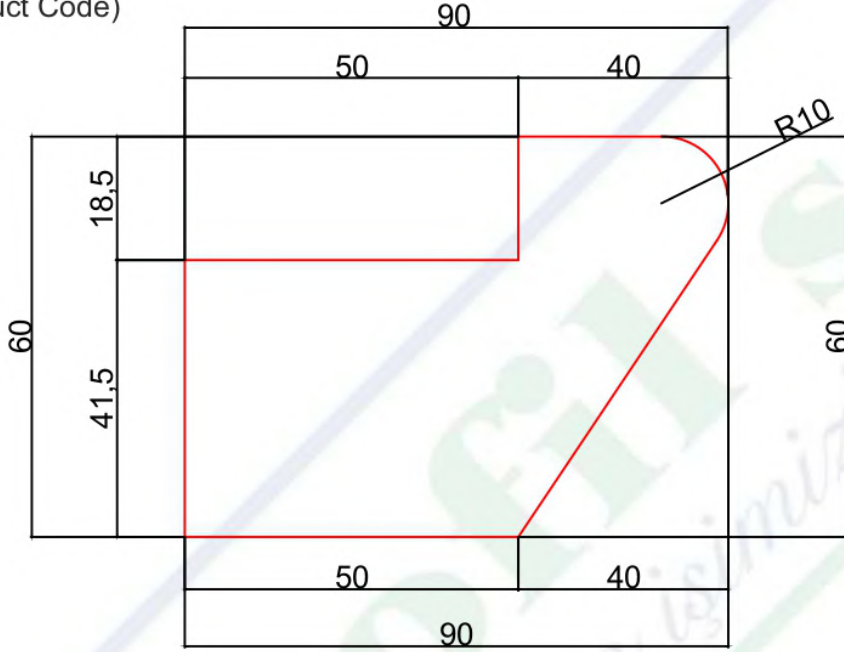

(Pvc ending area)

PVC BİTİŞ YERİ

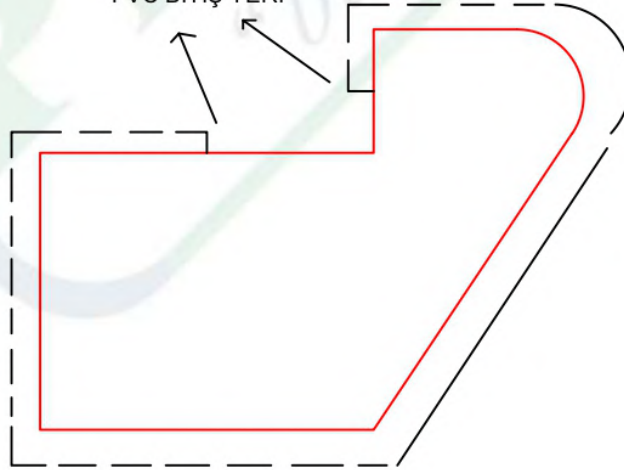

BÖLÜM SORUMLUSU NEJDET ALTINTOPRAK	BU ÇİZİM PROFİLSE - SİLAS ORMAN ÜRÜNLERİ'NE AİTTİR. İZİNSİZ ÇOĞALTILMAMAK VE KOPYA EDİLMEMEK ŞARTI İLE İZİN VERİLMİŞTİR.	PVC ENİ : MDF MİKTARI : PLAKADAN ÇIKAN :	KSM ÖLÇÜCÜ :	KUTU İÇİ : KUTU İÇİ ADET :
ARGE SORUMLUSU DOĞUKAN DEMİR	THIS DRAWING PROFILE - SİLAS FOREST PRODUCTS WHAT TO DO. UNLOCKED AND COPY NOT ALLOWED WITH THE WRITTEN.	GENEL TOLERANS : PROFİL BOY TOLERANSI :	MATERİYAL MM MDF	TARİH / DATE 10.10.2018

72 mm Profiles

PROFİLSE - SİLAS ORMAN ÜRÜNLERİ

KAĞIT ÜZERİNDEN ÖLÇÜ ALMAYINIZ !!!

Don't measurate on paper.

ÜRÜN KODU : 72*79

(Product Code)

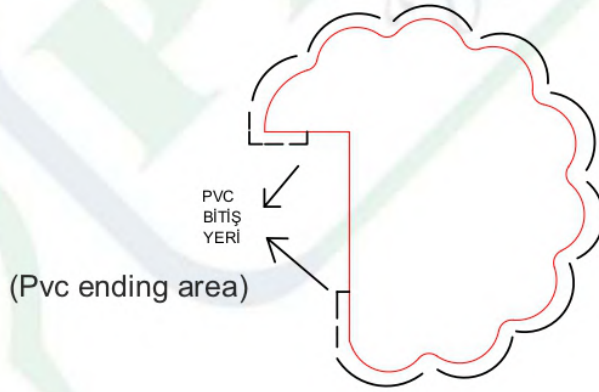
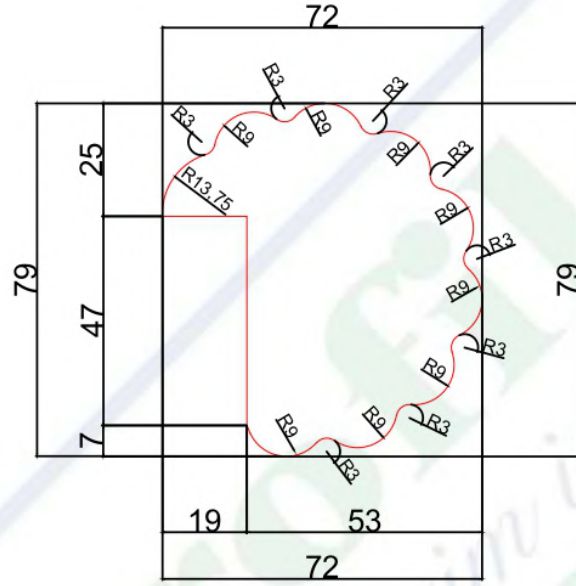

BÖLÜM SORUMLUSU NEJDET ALTINTOPRAK	BU ÇİZİM PROFİLSE - SİLAS ORMAN ÜRÜNLERİ'NE AİTTİR. İZINSİZ ÇOĞALTILMAMAK VE KOPYA EDİLMEMEK ŞARTI İLE İZİN VERİLMİŞTİR.	PVC ENİ : MDF MİKTARI : PLAKADAN ÇIKAN :	KSM ÖLÇÜCÜ :	KUTU İÇİ : KUTU İÇİ ADET :
ARGE SORUMLUSU DOĞUKAN DEMİR	THIS DRAWING PROFILE - SILAS FOREST PRODUCTS WHAT TO DO. UNLOCKED AND COPY NOT ALLOWED WITH THE WRITTEN.	GENEL TOLERANS : PROFİL BOY TOLERANSI :	MATERİYAL MM MDF	TARİH / DATE 06.12.2018